



University of Novi Sad, **Technical Faculty „Mihajlo Pupin“**, Zrenjanin, Serbia

SCIENTIFIC  
PROFESSIONAL CONFERENCE

# TEXTILE SCIENCE & ECONOMY X

PROCEEDINGS

Zrenjanin, May 20 - 21, 2019.



### **Organiser of the Conference:**

University of Novi Sad, Technical Faculty „Mihajlo Pupin“, Zrenjanin, Republic of Serbia

### **Publisher:**

University of Novi Sad, Technical Faculty „Mihajlo Pupin“, Zrenjanin, Djure Djakovica bb, 23000 Zrenjanin, Republic of Serbia.

### **For publisher:**

Dragica Radosav, Ph. D, Proffessor, Dean of the Technical faculty „Mihajlo Pupin“.

### **Cheaf editor:**

Vasilije Petrovic, Ph.D, Proffessor, Head of Department for textile and clothing science and design at Technical faculty "Mihajlo Pupin".

### **The Committee for editing:**

Ph.D Vasilije Petrovic, Technical Faculty „Mihajlo Pupin“, Zrenjanin, Serbia,  
Ph.D Jovan Stepanovic, Faculty of Technology, Leskovac, Serbia,  
Ph.D Goran Demboski, Faculty of Technology and Metallurgy, Skopje, Macedonia,  
Ph.D Dusan Trajkovic, Faculty of Technology, Leskovac, Serbia

### **Secretaries:**

Danka Joksimovic, M.Sc, Assistant  
Anita Milosavljevic, M.Sc, Assistant  
Stanislava Sindjelic, M.Sc, Assistant

### **Technical treatment and design:**

Vasilije Petrovic, Ph. D, Proffessor  
Danka Joksimovic, M.Sc, Assistant  
Anita Milosavljevic, M Sc, Assistant  
Stanislava Sindjelic, M.Sc, Assistant

### **ISBN:**

CIP - Каталогизacija u publikaciji  
Biblioteke Maticе srpske, Novi Sad

677(082)

### **INTERNATIONAL Scientific-Professional Conference Textile Science and Economy (10 ; 2019 ; Zrenjanin)**

Proceedings [Elektronski izvor] / 10th International Scientific-Professional Conference Textile Science and Economy, May 20-21st, 2019 Zrenjanin ; [cheaf editor Vasilije Petrovic]. - Zrenjanin : Technical Faculty "Mihajlo Pupin", 2019. - 1 elektronski optički disk (CD-ROM) : tekst, ilustr. ; 12 cm

Nasl. sa naslovnog ekrana. - Str. 4: Introduction / Vasilije Petrović. - Bibliografija uz svaki rad.

ISBN 978-86-7672-317-1

a) Текстилна индустрија - Зборници

COBISS.SR-ID 329407495

### **Note:**

All the papers presented in this publication have been reviewd. However the editor's and organizer are not responsible for the contents presented within paper.

## **THE SCIENTIFIC AND REVIEWING COMMITTEE:**

**Ph.D Jovan Stepanovic**, Faculty of Technology, Leskovac, Serbia, President of Committee,  
**Ph.D Xu Ming**, Dong Hua University, Shanghai, China,  
**Ph.D Wang Hua**, Dong Hua University, Shanghai, China,  
**Ph.D Nikola Zivlak**, Dong Hua University, Shanghai, China,  
**Ph.D Florea Hariton**, Universitatea de Vest din Timisoara – Facultatea de Arte, Romania,  
**Ph.D Riemschneider Eugenia Elena**, Universitatea de Vest din Timisoara – Facultatea de Arte, Romania,  
**Ph.D Laszlo Koltai**, Obuda University, Budapest, Hungary,  
**Ph.D Kisfaludy Marta**, Obuda University, Budapest, Hungary,  
**Prof. Dr. Roshan Paul**, University of Beira Interior, Portugal  
**Ph.D Darko Ujevic**, Faculty of Textile Technology, Zagreb, Croatia,  
**Ph.D Budimir Mijovic**, Faculty of Textile Technology, Zagreb, Croatia,  
**Ph.D Jelka Geršak**, University of Maribor, Slovenia,  
**Ph.D Goran Demboski**, Faculty of Technology and Metallurgy, Skopje, Macedonia,  
**Ph.D Sonja Kjartoseva**, Faculty of Technology and Metallurgy, Skopje, Macedonia,  
**Ph.D. Igor Jordanov**, Faculty of Technology and Metallurgy, Skopje, Macedonia,  
**Ph.D Samir Pacavar**, University of Travnik, Travnik, Bosnia and Herzegovina,  
**Ph.D Milan Gasovic**, University Singidunum, FFKMS, Serbia,  
**Ph.D Dusan Trajkovic**, Faculty of Technology, Leskovac, Serbia,  
**Ph.D Nenad Cirkovic**, Faculty of Technology, Leskovac, Serbia,  
**Ph.D. Dragica Radosav**, Technical Faculty „Mihajlo Pupin“, Zrenjanin, Serbia,  
**Ph. D Dusko Letic**, Technical Faculty „Mihajlo Pupin“, Zrenjanin ,  
**Ph.D Vasilije Petrovic**, Technical Faculty „Mihajlo Pupin“, Zrenjanin, Serbia,  
**Ph.D Visnja Mihajilovic**, Technical Faculty „Mihajlo Pupin“, Zrenjanin,  
**M.Sc Srdjan Cakic**, Faculty of Technology, Leskovac, Serbia,  
**M.Sc Danka Joksimovic**, assistant, Technical Faculty „Mihajlo Pupin“, Zrenjanin,  
**M.Sc Anita Milosavljevic**, assistant, Technical Faculty „Mihajlo Pupin“, Zrenjanin,  
**M.Sc Marija Pesic**, assistant, Technical Faculty „Mihajlo Pupin“, Zrenjanin,  
**M.Sc Stanislava Sindjelic**, asstant, Technical Faculty „Mihajlo Pupin“, Zrenjanin.

## **ORGANIZING COMMITTEE:**

**Ph. D Vasilije Petrovic**, Technical Faculty „Mihajlo Pupin“, Zrenjanin, President of Committee,  
**Ph. D Dragica Radosav**, Technical Faculty „Mihajlo Pupin“, Zrenjanin,  
**Ph. D Dusko Letic**, Technical Faculty „Mihajlo Pupin“, Zrenjanin,  
**Milorad Vasiljevic**, secretary for textiles in Chamber of commerce of Serbia,  
**Dragomir Djukic**, Chamber of commerce of Vojvodina,  
**Novica Abadzic**, Chamber of commerce of Vojvodina,  
**MSc Snezana Milosevic**, S.M.Style, Beograd,  
**Marko Marinkovic**, Sitotehnika d.o.o., Beograd,  
**Golub Radivojevic**, Mona d.o.o., Beograd,  
**Ivan Radovanovic**, Mitek d.o.o., Arilje,  
**Bogomir Bojic**, Mondeks d.o.o., Novo Milosevo,  
**Nikola Kaljevic**, In Trikotaza d.o.o., Arilje,  
**Nenad Jovic**, Victory Style, Novi Sad – Rumenka,  
**Mladen Jovic**, Victory Style, Novi Sad – Rumenka,  
**Anel Adrovic**, La Vista d.o.o., Berane  
**Ph.D Nadežda Ljubojev**, Technical Faculty „Mihajlo Pupin“, Zrenjanin,  
**Ph.D Visnja Mihajilovic**, Technical Faculty „Mihajlo Pupin“, Zrenjanin,  
**M.Sc Danka Joksimovic**, assistant, Technical Faculty „Mihajlo Pupin“, Zrenjanin,  
**M.Sc Anita Milosavljevic**, assistant, Technical Faculty „Mihajlo Pupin“, Zrenjanin,  
**M.Sc Marija Pesic**, assistant, Technical Faculty „Mihajlo Pupin“, Zrenjanin,  
**M.Sc Stanislava Sindjelic**, asstant, Technical Faculty „Mihajlo Pupin“, Zrenjanin,  
**Jelena Djukic**, student, Technical Faculty „Mihajlo Pupin“, Zrenjanin,  
**Ivana Lukic**, student, Technical Faculty „Mihajlo Pupin“, Zrenjanin,  
**Ivana Jelic**, student, Technical Faculty „Mihajlo Pupin“, Zrenjanin,  
**Milica Stojanovic**, student, Technical Faculty „Mihajlo Pupin“, Zrenjanin,  
**Maja Kostic**, student, Technical Faculty „Mihajlo Pupin“, Zrenjanin,  
**Aleksandra Savić**, student, Technical Faculty „Mihajlo Pupin“, Zrenjanin.

## FOREWORD

Department of Textile and clothing Science and Design of the Technical faculty “Mihajlo Pupin” University of Novi Sad organizes the tenth international conference “Textile science and economy X” TNP2019.

Guided by the fact that we are good people who make good products, on our conference we gather experts from science and economy. From year to year we have followed development of science and economy in this sector. From the very beginning we have cooperated with scientists from all over the world, from America to China. A lot of businessmen from the field of production also participated in our conferences. Experts from the French company Lectra have undoubtedly made a significant contribution to the improvement of quality. They have given us information about modern economic trends and worldwide trends in textile and materials. They haven't only allowed us to access the developing information in this field, they have also equipped us with their own equipment which values about a million euros. We have also had the CAM machine from generation of 4.0 Industrial Revolution or several years now. It represents the best equipment in this part of the Europe. The equipment was mostly obtained from the IPA project of our cooperation with Faculty of Arts and Design, West University of Timisoara.

Meetings of experts from science and economy at our conferences have constantly raised the level of our international cooperation. That provided the exchange of our professors and our students in middle European program CEEPUS, in which about 50 of our students have taken a part. Seventeen of our students and 10 of our professors have taken a part in Erasmus program. For the first time in our faculty, we have one foreign student on exchange. About 40 students from textile were in practice in German companies and about 15 students and two professors were in two programs at Donghua University in Shanghai. Working under the name of „Innovative approach in the education of textile engineers for the Serbian textile industry“, we succeeded to include the University of Novi Sad into the Belt and Road World Textile University Alliance, with the company of 33 prestigious universities from all around the world, at the conference on Donghua University in Shanghai in 2018. It is also a great success that we have been elected to be part of the board of this Alliance.

Our next projects with Donghua University, which we are going to talk about at this conference, are going to be: organizing international summer schools, fashion shows, exchanges of professors and students, mutual projects for economy, all within the Belt and Road World Textile University Alliance.

Our vision is to train students, who will, with their knowledge, easily get the jobs that are required by domestic and international companies. Our goal is for our students to be the driving force in enterprises of the Serbian textile industry which will have employed 30 engineers each, and few sewers of samples who will do the sewing jobs in countries with cheap labor. We are going to increase the level of the Conference to a greater extent so that it will be the meeting point for our and foreign scientists and businessmen to open new cooperation activities. We want to involve our students in these jobs.

This Conference can be the initiator of strategic state project of Renaissance production of industrial cannabis. More than 6000 products wanted on the market are made of cannabis. The Kingdom of Yugoslavia produced a quarter of European production in total, and Odzaci was European stock market which determined price of the cannabis. Our department has already begun with project activities in that direction with two institutes from Novi Sad.

We are going towards direction to inn greater extent raise the level of Conference so that could be place of encounters of ours and foreign scientists and businessmen making new businesses we want to include our students as well.

At this tenth conference, we will promote the signed Contract in Shanghai with the regional association Jiangsu Haimen Industrial Zone which employs 500,000 workers, and which will involve our students in the design of home textile for Chinese companies. This is a great step in achieving our initial idea of organizing conferences, which is to create quality students who will produce quality products. We consider it a great success that our students were recognized by the world's strongest Haimen group in home textile

In the end, I would like to thank all previous participants of our conferences and all those who contributed to the success we have achieved.

President of Organizing Committee:

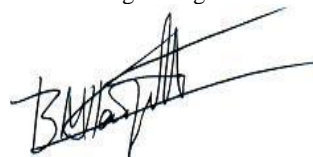

Prof. dr Vasilije Petrović

## FLAGS OF PARTICIPATING COUNTRIES



**Serbia**



**China**



**Turkey**



**Croatia**



**Romania**



**Macedonia**



**Hungary**



**Cambodia**



**Bosnia and Herzegovina**



**Ethiopia**



**Iran**



**Sweden**



**Germany**

## **WORD OF THANKS**

### **Thanks for the partnership:**

- **Ministry of Education, Science and Technological Development Republic of Serbia**
- **Ministry of Economy, Republic of Serbia**
- **City of Zrenjanin, Republic of Serbia**
- **Donghua University, Shanghai, China**
- **Faculty of Arts and Design, West University of Timisoara, Romania**
- **Faculty of Engineering, Pamukkale University, Denizli, Turkey**
- **Serbian Chamber of Commerce**
- **Company Sitotehnika, Serbia**
- **Company Miteks, Serbia**
- **Company Liteks M, Serbia**
- **Company In Trikotaza, Serbia**
- **Company Victory Stil, Serbia,**
- **for support the conference TNP 2019**





## CONTENT

<b>John Wilson</b> BELT AND ROAD WORLD TEXTILE UNIVERSITY ALLIANCE _____	13
<b>Andrej Agačević, Xu Ming</b> UNIVERSITIES AS A POTENTIAL LINK IN HOME TEXTILE E-COMMERCE RESEARCH BETWEEN CHINA AND EAST EUROPE _____	17
<b>Meiqun Na, Guoxiang Yuan</b> ANALYSIS ON GUIZHOU'S TRADITIONAL CRAFT BRAND BUILDING _____	23
<b>Gabrijela Grujić</b> DUAL EDUCATION _____	30
<b>Marko Marinkovic, Vladimir Milakovic</b> TRENDS IN DIGITAL TEXTILE PRINTING DEVELOPMENT TECHNOLOGICAL PROCESS _____	32
<b>Ece Kalayci, Arzu Yavas, Ozan Avinc, Tugce Tonguc</b> DYEING PERFORMANCE COMPARISON OF SOYBEAN FIBERS WITH DIRECT DYES WITH CONVENTIONAL AND MICROWAVE TECHNOLOGIES _____	36
<b>Can B. Kalayci, Ece Kalayci, Ozan Avinc, Arzu Yavas</b> COLOR STRENGTH ESTIMATION OF RAFFIA FIBERS AFTER DIFFERENT ALKALI TREATMENTS _____	44
<b>Ece Kalayci, Arzu Yavas, Ozan Avinc</b> USAGE OF DIGITAL AND 3D PRINTING TECHNOLOGIES IN DENIM JEANS DESIGN AS AN ECOLOGICAL SOLUTION _____	51
<b>Eugenia Elena Riemschneider</b> INTELLIGENT TEXTILE MATERIALS _____	59
<b>Samir Pačavar</b> TEXTILE INDUSTRY IN BOSNIA AND HERZEGOVINA _____	66
<b>Ramisa Yahyapour, Mohammad Sajad Sorayani Bafqi, Masoud Latifi, Roohollah Bagherzadeh</b> EVOLUTION OF THE PERFORMANCE OF NON-PIEZO LAYERS ON FLEXIBLE PIEZOELECTRIC HARVESTERS _____	71
<b>Niloufar Khomarloo, Roohollah Bagherzadeh</b> CHALLENGES REVIEW ON FUNCTIONAL FIBROUS MATERIALS BASED ELECTRONICSKIN _____	76
<b>Edit Csanák</b> CRAFT & TRADITION: CHALLENGES OF REINTERPRETING NATIONAL HERITAGE IN FASHION AND TEXTILE DESIGN _____	83

<b>Fitsum Etefa</b> DESIGN AND DEVELOPMENT OF MANUAL HANK REELING MACHINE _____	90
<b>Gebregziabher Kidus Tesfamariam</b> TEXTILE AND GARMENT INDUSTRIES IN ETHIOPIA _____	97
<b>Emilija Toshikj, Goran Demboski, Igor Jordanov, Biljana Mangovska</b> SEAM PUCKERING OF COTTON SHIRT AFTER LAUNDERING _____	100
<b>Emilija Toshikj, Igor Jordanov</b> ALKALI SENSITIVITY OF OXY-CELLULOSES _____	105
<b>Nina Mladenovic, Emilija Toshikj, Igor Jordanov, Vesna Dimova, Dejan Dimitrovski</b> RICE HUSK AS BIO-ADSORBENT FOR DIRECT DYES REMOVAL FROM AQUEOUS SOLUTION: EQUILIBRIUM STUDY _____	109
<b>Blaženka Brlobašić Šajatović, Ksenija Doležal, Renata Hrženjak, Darko Ujević</b> INFLUENCE OF ANTHROPOMETRIC MEASUREMENTS ON THE SYSTEM SIZE OF BRAS _____	114
<b>Vojislav Gligorijevic, Goran Demboski, Radica Nacic, Jovan Stepanovic, Nenad Cirkovic</b> MODELING AND MECHANICS OF CROSS-KNITTED KNITWEAR _____	121
<b>Slaviša Djurdjević, Marija Pešić, Vasilije Petrović, Danka Joksimović, Anita Milosavljević</b> A RESEARCH OF THERMAL PROPERTIES OF DYED 1x1 RIB KNITTED FABRIC _____	127
<b>Nenad Stojanovic, Anita Milosavljević, V. Petrović, D. Trajkovic, D. Joksimović, M. Pesic</b> ANALYSIS OF THE INFLUENCE OF THE DENSITY OF FABRICS ON ITS STRENGT ____	133
<b>Marija Pešić, Vasilije Petrović, Danka Joksimović, Anita Milosavljević, Stanislava Sindelić</b> INFLUENCE OF THE STRUCTURE OF TEXTILE MATERIALS ON THE COMFORT OF CLOTHING _____	139
<b>D. Joksimović, V. Petrović, M. Pešić, A. Milosavljević, S. Sindelić, N. Petrović</b> METHODS OF NC GUIDANCE IN THE CASE OF AUTOMATIC MACHINES AND AGGREGATES _____	145
<b>Veasna Tith</b> CAMBODIAN SILK _____	154
<b>Maja Jankoska, Goran Demboski</b> PRESSING PERFORMANCE OF WOVEN FABRICS FOR MEN'S SUIT _____	159
<b>Dragan Djordjic, Mirjana Reljic, Jovan Stepanovic, Vasilije Petrovic</b> ANALYSIS OF CHARACTERISTICS OF THE WOOL YARN AND MIXTURES OF WOOL AND POLYAMIDE YARN FOR KNITTING SWEATER _____	164
<b>Anđela Đurašković, Jovana Lazić, Tatjana Šarac, Nenad Ćirković</b> CONSTRUCTIONAL PREPARATION OF DRESS INSPIRED BY NATURAL TEXTURES _____	171

<b>Marija Pešić, Vasilije Petrović, Danka Joksimović, Anita Milosavljević, Stanislava Sindelić</b> INFLUENCE OF THE RAW MATERIAL COMPOSITION OF KNITWEAR ON COMFORT CLOTHES _____	178
<b>Anita Milosavljević, V. Petrovic, D. Trajković, D. Joksimovic, M. Pesic, S. Sindelic</b> ANALYSIS OF THE IMPACT OF FABRIC PARAMETER ON DEFORMATION CHARACTERISTICS OF STITCH _____	183
<b>Maja Jankoska</b> DESIGN OF WOMEN'S CAPE AND MODELING WITH APPLIED ELEMENTS OF JACKET _____	189
<b>Mihalj Bakator, Dragan Čočkalo, Dejan Đorđević, Sanja Stanisavljev, Srđan Bogetić</b> IMPROVING COMPETITIVENESS THROUGH CLUSTERING IN THE DOMESTIC TEXTILE INDUSTRY _____	197
<b>Tatjana Šarac, Nenad Ćirković, Jovan Stepanović, Dušan Trajković, Nataša Stamenković</b> THE CHANGE IN DRAPE COEFFICIENT OF WOVEN FABRICS WITH SEAMS _____	203
<b>Nadežda Ljubojev, Mila Kavalić, Sanja Stanisavljev</b> SUBJECT OF COPYRIGHT _____	209
<b>Anita Milosavljević, V. Petrović, D. Joksimovic, M. Pesic, S. Sindelic</b> ANALYSIS OF THE IMPACT OF SINGLE PARAMETERS ON DEFORMATION CHARACTERISTICS OF STITCHES _____	215
<b>Milica Stojanović, V. Petrović, A. Milosavljević, D. Joksimović, M. Pesic</b> TECHNOLOGY OF MAKING DRESSES WITH ETHNO MOTIVE _____	225
<b>Jelena Đukić, V. Petrovic, D. Joksimovic, A. Milosavljevic, M. Pesic, S. Sindjelic</b> NATIONAL COSTUMES OF UŽICE REGION _____	233
<b>Jovan Radisic, Vasilije Petrovic, D. Joksimovic, A. Milosavljevic, S. Sindelic, J. Stepanovic</b> APPLICATION OF TEXTILE MATERIALS IN THE AUTOMOTIVE INDUSTRY _____	241
<b>Valentina Bozoki, Vasilije Petrovic, D. Joksimovic, A. Milosavljevic, S. Sindelic, J. Stepanovic</b> LOUIS VUITTON - LORD OF BAGS _____	250
<b>Mina Milaković, V. Petrovic, D. Joksimovic, A. Milosavljevic, M. Pesic</b> EMBROIDERY ON BANAT NATIONAL COSTUMES _____	260
<b>Ivana Krulj, V. Petrovic, D. Joksimovic, A. Milosavljevic, M. Pesic, S. Sindjelic</b> NATIONAL COSTUME OF THE MACVA AS AN INSPIRATION FOR CONTEMPORARY FASHION _____	266
<b>Valentina Bozoki, Vasilije Petrovic, J. Danka, M. Anita, S. Stanislava</b> APPLICATION OF TEXTILE FOR DIVING SUITS _____	274



## BELT AND ROAD WORLD TEXTILE UNIVERSITY ALLIANCE

**Professor John Wilson,**  
Donghua University, Shanghai, China  
[johnwilson@dhu.edu.cn](mailto:johnwilson@dhu.edu.cn)

### INTRODUCTION

The Belt and Road Initiative (BRI) was launched in 2013 and comprises the 21<sup>st</sup> century Maritime Silk Road plus the Silk Road Economic Belt. The Maritime “Road” offers huge opportunities as it covers approximately 65% of the global population and 45% of its GDP, excluding China. The landlocked ‘belt’ connects China and Europe. There are five major goals of the BRI i.e. policy coordination; facilities connectivity; unimpeded trade; financial integration; people-to-people bonds. The BRI is a key component of China’s international strategy and is intended to create an interconnected world, including physical and digital infrastructure, reflected in the numerous countries that are participating, approximately 65 at present. As President Xi stated at the Belt and Road Forum, April 2019, ‘All interested countries are welcome to join us. While the Belt and Road Initiative was launched by China, its opportunities and outcomes are shared by the world.’

One of the countries involved in the BRI is Serbia. At the third international conference organised by the Belgrade Strategic Dialogue titled "Belt and Road Initiative in the Balkans", Serbia’s PM, Ana Brnabic, said that citizens of Serbia can already see the results of the BRI in the construction of new roads and bridges, the reconstruction and modernisation of railways, the implementation of energy and environmental protection projects, as well as in enhanced cooperation between the companies of the two countries. PM Brnabic estimated that the Chinese companies already present in the Serbian market have preserved 5,000 jobs at the Smederevo steelworks, which were taken over by Hesteel in 2016, and will secure another 5,000 jobs at the Mining and Smelting Combine Bor, thanks to China’s Zijin Mining Group. Chinese Ambassador to Serbia Li Manchang said there is great potential for cooperation between China and Serbia in agriculture and the construction of industrial parks at several locations across the country.

Within the context of the BRI, the World Textile University Alliance (WTUA) was launched in December 2018 at Donghua University, Shanghai. It is an unincorporated academic body collectively established by world-renowned universities, including those in Belt and Road countries, in the fields of textile engineering, fashion engineering, design, technology and innovation. It comprises 32 university members as at May 2019 i.e. 13 Chinese universities plus 20 universities drawn from 19 countries around the world. Please see Table 1.

The purpose of the WTUA is as follows, with a specific focus on the textile and related industry:

- Capitalise on the unprecedented opportunities afforded by the BRI
- Promote common development and prosperity
- Strengthen academic and scientific cooperation
- Promote scientific and technological progress
- Promote art design in textile, apparel and related industries

<b>Table 1 WTUA Members as at May 2019</b>
<b>China</b>
Beijing Institute of Fashion Technology; Dalian Polytechnic University; Donghua University; Jiangnan University; Qingdao University; Soochow University; Tianjin Polytechnic University; Tibet University; Wuhan Textile University; Xi'an Polytechnic University; Xinjiang University; Zhejiang Sci-Tech University; Zhongyuan University of Technology
<b>Rest of the World</b>
Aalto University (Finland); Amirkabir University of Technology (Iran); Bahir Dar University (Ethiopia); BGMEA University of Fashion & Technology (Bangladesh); University of Edinburgh (UK); ENSAIT – Ecole Nationale Supérieure des Arts et Industries Textiles (France); University of Gezira (Sudan); Kulob Institute of Technology and Innovation Management (Tajikistan); Moi University (Kenya); Mongolian University of Science and Technology (Mongolia); National Textile University (Pakistan); University of Novi Sad (Serbia); Reutlingen University of Applied Sciences (Germany); The Royal University of Fine Arts (Cambodia); University of the South Pacific (Fiji); Sudan University of Science and Technology (South Sudan); Suez University (Egypt); Tashkent Institute of Textile and Light Industry (Uzbekistan); UPM – Universidad Politecnica de Madrid (Spain); University of Westminster (UK)

Activities relating to talent development include:

- Promote joint talent training
- Hold seminars and facilitate exchanges
- Collaborate to meet the talent needs of textile enterprises
- Conduct government-industry-university research
- Seek governmental support to expand the number of scholarships for students studying in Alliance member universities, for long- and short-term study periods
- Establish a Belt and Road scholarship for outstanding international students jointly with related enterprises
- Formulate a method for mutual recognition of credits
- Explore joint training of high-level talents
- Organise the Alliance members to set up an editorial committee for publishing professional teaching materials of courses taught in English and research-based working papers.

With regards to science and technology:

- Collaborate in scientific and technological innovation.
- Establish a cluster of Belt and Road scientific and technological consulting service stations and international laboratories
- Facilitate the exchange of knowledge and new technologies among experts and industries from Belt and Road countries and beyond
- Hold annual conferences on technical developments and exchanges.

In relation to culture and arts promotion:

- Strengthen fashion, cultural and people-to-people exchanges
- Host Belt and Road International Fashion Weeks and invite each member to participate
- Conduct academic exchanges and research projects pertaining to themes such as the Belt and Road fashion trends, fashion and folk customs and language and culture
- Explore the Belt and Road historical and cultural heritage
- Hold a Belt and Road World Youth Fashion Design Competition
- Demonstrate the spirit of friendly cooperation of the Belt and Road countries by organizing the exchange of young artists and designers from all over the world and encouraging young designers worldwide to form a joint fashion design studio.

The WTUA will particularly consider all of the above at its planned General Assembly. The Assembly, and all other events, will be undertaken on a non-profit, break-even, basis to allow opportunities for all Alliance members to host events and members will have discretion to levy fees to enable costs to be recovered.

To encourage and promote membership, the WTUA is inclusive and interested parties can submit an application to the Secretariat (see below) for consideration by the Board. The Board will decide, taking into account views of Alliance members as appropriate. In the event a member wishes to withdraw from the Alliance, a notification in writing should be received by the Secretariat three months in advance of the intended withdrawal date and the Secretariat will amend the Alliance's official website on the date of withdrawal.

In terms of governance, the WTUA has a Steering Board and a Secretariat. There is also the possibility that Special Interest Groups, with devolved responsibilities, may be established at the discretion of the Steering Board.

With regards to the Steering Board, this is chaired by Donghua University and the following arrangements prevail until 31 January 2022 unless agreement is made to change them:

- Nine members
- Three members drawn from Chinese universities and six from rest-of-the-world members (selected primarily to ensure a good geographical spread and following invitations for expressions of interest)
- First meeting of the Board held in April 2019 following invitation to all WTUA members to suggest agenda items
- Meeting was virtual i.e. technology-enabled.

Details of the Steering Board are given in Table 2:

<b>Table 2 Steering Board Membership</b>		
<b>Organisation</b>	<b>Name</b>	<b>Designation</b>
Donghua University (China) (Chair)	Dr Zhao Mingwei	Director, International Co-operation Office
University of Edinburgh (UK)	Prof Natascha Gentz	Assistant Principal (China)
University of Gezira (Sudan)	Professor Mohamed Elsanousi Mohamed	Vice-Chancellor
Moi University(Kenya)	Professor Peter Simatei Tirop	Dean, School of Arts and Social Science
National Textile University (Pakistan)	Professor Tanveer Hussain	Rector
University of Novi Sad (Serbia)	Professor Dr Vasilije Petrovic	Vice-Dean, Dept of Textile Clothing and Design
Reutlingen University of Applied Sciences (Germany)	Professor Dr Jochen Straehle	Professor, School of Textiles and Design
Tianjin Polytechnic University (China)	Associate Professor Zhang Xingguo	Director, International Office
Wuhan Textile University (China)	Professor Lin Li	Director, International Office

To illustrate the types of activities that are being or will be undertaken, please note:

- Sustainable fashion activities
- Training program for Belt and Road Textile entrepreneurs
- Training base for Textile talents in B&R countries (Africa)
- Joint laboratory with Belt and Road countries
- Shanghai Summer School featuring Fashion
- Fashion week (Fiji, Uzbekistan etc)
- Edinburgh Fringe
- Rio de Janeiro event
- Greater Donghua Fashion Week

As stated above, the WTUA is inclusive and potential partners are very welcome to make contact should they wish to explore further. The contact email is: [wtua@dhu.edu.cn](mailto:wtua@dhu.edu.cn).



## UNIVERSITIES AS A POTENTIAL LINK IN HOME TEXTILE E-COMMERCE RESEARCH BETWEEN CHINA AND EAST EUROPE

Andrej Agačević<sup>1</sup>, Xu Ming<sup>2</sup>

- 1) Glorious Sun School of Business and Management, Donghua University, Shanghai, China
- 2) Glorious Sun School of Business and Management, Donghua University, Shanghai, China  
a.agacevic@gmail.com, xuming@dhu.edu.cn\*

### ABSTRACT

*E-commerce has grown very fast in China, but Cross Boarder E-commerce (CBEC) has developed relatively slowly. One of the main reasons is lack of suitable business model. An analysis of the development trend of E-commerce in China, CBEC in EU and China in Home Textile field is conducted and comparisons are made. Based on the results, a hypothesis of Central East European Countries (CEEC) as potential market to be reached through CBEC is put forward, especially involving universities related in Textile research. Although China's textile and apparel industries have faced light decline since 2016, China's domestic E-commerce has grown rapidly, with average increase rate of 27%, while China's CBEC has lagged behind. Comparatively speaking, both domestic E-commerce and CBEC in EU yield less profit than Chinese ones. Data in Textile and Home Textile product shopping in 16 CEEC countries, of which some are outside EU, was considered, revealing a potential for big growth of Home Textile CBEC via specialized platforms between China and CEEC region. Existing relationships between Textile oriented universities on both sides could be used as a driving force to involve other actors in their territory, leading research and solving issues, while potentially jointly incubating Home Textile CBEC platforms, as Donghua University in China and Novi Sad University in Serbia have jointly initiated collaboration with Dear Shiqiao Home Textile Industry Park.*

**Key words:** Home Textile, Cross Boarder E-commerce (CBEC), E-commerce, China, Central East Europe, Belt and Road

### 1 INTRODUCTION AND RESEARCH QUESTIONS

After Amazon and eBay launches in USA in 1994-95, Alibaba.com and made-in-china.com appeared in 1998 as representatives of B2B in China. Taobao.com and Jindong.com followed in 2003, in the B2C format. Smartphones became diffused, allowing China's E-commerce to reach 31.63 trillion Yuan (CNY) in 2018, which was about 35.13% of that year's Chinese GDP.

Since 2010, China has become world's largest manufacturer, covering 20% of the world's production. Textile and apparel industries became world's largest ones, with variety of colorful product categories and high performance/cost ratio. Home Textile industry in China is a typical representative of China's textile industry.

China's Textile and apparel industries had a slight downtrend since 2016, with textile products export declining by 2.3% and apparel export by 6.4%<sup>1</sup>, marking the first time China's Textile industry dropped for two consecutive years in last two decades<sup>2</sup>. Recently, Chinese Premier Li Keqiang delivered a report in Beijing, in which he pointed out that yarn production in 2018 dropped by 7.3% and cloth by 4.9%<sup>3</sup>. The question is how the decline of world's strongest textile industry can be stopped?

---

<sup>1</sup> Consumer Goods Industry Division of Ministry of Industry and Information Technology of the People's Republic of China, Operation of Textile Products in 2015,

<http://www.miit.gov.cn/n1146312/n1146904/n1648366/n1648368/c4630316/content.html>

<sup>2</sup> Chen Xiao and Wang tingting, Export Difficulties faced by China's Textile and Apparel Industries Under New Situation, Foreign Trade Business, 2017 (5) <http://qikan.com.cn>

<sup>3</sup> Li Keqing, China government work report at the opening meeting of the second session of the 13th National People's Congress in Beijing, March 5 2019

Could Home Textile Cluster Center-Deer Shiqiao Park (DSQ), the largest region focused on Home textile products, taking up more than 40% of China’s Home Textile Industry, serve as a guiding example of healthy development of the region? Can international retailing Cross-Border E-commerce (CBEC) or similar innovative solutions bring benefits both to the Textile industry and to final consumer, globally, and where and how to test such solutions? In terms of this kind of research, could Universities that specialize in Textile industry provide a fertile ground for testing and implementing potential solutions in CBEC? In the Belt and Road Initiative (BRI) framework, could such Universities form a link between China and Central East European Countries? The research brought forward in this paper suggests that a direct collaboration between Universities specialized in Textile industry are a solid fit to become links in CBEC.

## 2 REVIEW OF E-COMMERCE DEVELOPMENT IN CHINA

Since the launch of several online platforms for E-commerce, China’s E-commerce has seen a steady growth in the last decade, documented by China E-commerce Research Center, (T.V. stands for Turnover Value, which is the original term used in the original version in Chinese) <sup>4</sup>. Data from the China E-commerce Development Report 2017 <sup>5</sup> and China Internet Conference (April 22, 2019) <sup>6</sup>, have been used to compile the Table 1, indicating the development of E-commerce in China.

As China’s yearly GDP in 2018 is 90.03 trillion yuan,<sup>7</sup> China’s E-commerce reached 35.13% of GDP, which is the second year the E-commerce percentage reached over one thirds of whole nation’s GDP (previous year is 35.5%). The average yearly increase rate is about 27.07% (2011-2018).

*Table 1 E-commerce Development in China, in trillions of Yuan*

Year	2008	2011	2012	2013	2014	2015	2016	2017	2018
<b>T.V</b>	3.14	6	7.85	10.2	13.4	18.3	22.97	29.16	31.63
<b>Inc.%</b>	-	-	30.8	29.9	31.4	36.6	25.5	26.9	8.4

Out of three parts of E-commerce (B2B, B2C, C2C), B2B is the largest one in China whereas B2C is relatively smaller. The growth of China’s Domestic E-commerce in Retail has been given in the Table 2.

*Table 2 China’s Domestic E-commerce in Retail, in trillions of Yuan*

Year	2013	2014	2015	2016	2017
<b>T.V</b>	1.89	2.82	3.83	5.33	7.18
<b>Inc.%</b>	42.7	49.6	35.7	39.2	34.5

Compared to the data from Table 1, the percentage of Turnover Value of domestic E-commerce in Retail to whole E-commerce in China (2013-2017) is, respectively, 18.5%, 21.8%, 20.9%, 23.2% and 24.6% with the average increase rate of 21.8%.

In Table 2, each year’s increase rate is clearly seen as very high with an average increase rate of 40.3%. In order to better understand the situation in China’s Cross-Board E-commerce (CBEC), Table 3 provides solid data until 2018, included, provided by China E-commerce Market Information Supervision Report in 2016<sup>8</sup> and Li Jie’s research<sup>9</sup> Datum of 2018 is from Zheng Jie’s research.<sup>10</sup>

<sup>4</sup> Journalist Report, China’s Internet Reaches Second Half, 21th Century Economic Report, April 22, 2019. <https://baijiahao.baidu.com/s?id=1631519370739386469&wfr=spider&for=pc>

<sup>5</sup> Ministry of Commerce of the People’s Republic of China, China E-Commerce Development Report 2017, <https://news.takunpao.com>

<sup>6</sup> China Internet Conference News Report, China’s Netizen 829 million and yearly turnover 31.61 trillion RMB, <https://tech.sina.com.cn/i/2019-04-23/doc-ihvhiewr7632183.shtml>

<sup>7</sup> National Bureau of Statistics of China, Statistical Communique of the People’s Republic of China on the 2018 National Economic and Social Development, February 28, 2019

<sup>8</sup> Wang Shuyi, Research on International Trade Professionals’ Training Mode under the

*Table 3 China Cross-Board E-commerce Transaction Development, in trillions of Yuan*

Year	2011	2012	2013	2014	2015	2016	2017	2018
<b>CBEC</b>	1.7	2.1	3.15	4.2	5.4	6.7	7.6	9.7

Comparing the data on E-commerce Development from Table 1 against CBES from Table 3, Table 4 offers the Percentage of CBEC/Turnover Value for 2011-2018.

*Table 4 China's Percentage of CBEC/Turnover Value (2011-2018), in trillions of Yuan*

Year	2011	2012	2013	2014	2015	2016	2017	2018
<b>T.V</b>	6	7.85	10.2	13.4	18.3	22.97	29.16	31.63
<b>CBEC</b>	1.7	2.1	3.15	4.2	5.4	6.7	7.6	9.7
<b>CBEC/T.V%</b>	28.3	26.8	30.9	31.3	29.5	29.2	25.7	30.7

The CBEC/Turnover Value oscillates around 30% in the last decade. According to China E-commerce Research Center's supervision, C2C and C2B are relatively limited, especially in terms of CBEC, while B2B takes up 85.2% of CBEC, and B2C only 14.8%.<sup>11</sup> This opens enquiries as to how would it be possible to increase B2C in CBEC, and what are the challenges faced by Chinese goods suppliers?

### ***Dear Shiqiao Home Textile Industry Park Case***

***Dear Shiqiao Home Textile Industry (DSQ) is mainly related with Haimen City and Tongxian County's 17 villages and towns, which is located in Southern Jiangsu Province, about 120 km from Shanghai. Famous for Home Textile Production, it is China's Number One Home Textile Supply Base and a market with yearly turnover of 100 billion yuan in 2018. Since 2008, DSQ had an influx of E-commerce firms: approximately 11,550 SMEs use online business for selling Home Textile products, mainly on large platforms, such as Taobao, Jingdong, Amazon, Alibaba, and Aliexpress. The sales value of E-commerce in DSQ area in 2014 was about 12 billion yuan, growing to 19.5 billion yuan in 2015, an increase of 62.5%. In 2015, for the November 11, the so-called "Single's Day" (11.11), Alibaba launched its "Single's Day online shopping" campaign that also impacted Home Textile Product Shopping in DSQ, reaching 780 million yuan on that date.***

The local government in DSQ has showed the intention to promote Home Textile E-commerce firms towards international markets. This year Belt and Road Dear Shiqiao Import and Export Commodity Fair will be held at DSQ Market, from May 16 to 19, 2019. The Fair is hosted by Jiangsu Haimen People's Government, and jointly organized by Jiangsu Haimen Industrial Park Administrative Committee, China National Textile and Apparel Council together with China Chamber of Commerce for Import and Export of Textile and Apparel.

The Jiangsu Haimen Industrial Park Administrative Committee has announced a guiding policy for local Home Textile firms aiming to assist them in setting up pioneer E-commerce centers abroad, especially in Belt and Road region, fostering chances for international cooperation.

Background of Cross-border E-commerce — —Take Applied Universities for Example, JOURNAL OF EDUCATIONAL INSTITUTE OF JILIN PROVINCE, No.12, 2018, Vol.34, Total No.456:38-41

<sup>9</sup> Li Jie, Analysis of China's Cross-Board E-Commerce Challenge with Coordinated Logistic Model, E Business Journal, 2019 (4):31-34+52

<sup>10</sup> Zheng Jie, On the Construction of Innovative Model of Cross-border E-Commerce Talents Training in Higher Vocational Colleges, JOURNAL OF SHANXI INSTITUTE OF ECONOMIC MANAGEMENT, 2018 26 ( 4 ) : 113-116

<sup>11</sup> Wang Yu, Exploration of Cross Board E-Commerce Model Development in the view of Jiangsu Province Case, Modern Marketing, Version 2017-2018: 160-161 <http://www.cnki.net>

## OVERVIEW OF CBEC GROWTH IN EU

In 2016, Europe's CBEC total value was 530.6 billion Euro, which increased up to 15.4% from previous year. Among 870 million European people, 570 million, or 65.5%, are "netizens", and 260 million of them, or 45.6%, are active online buyers, most residing in UK, Germany and France. UK's CBEC value in 2016, in EUR, was 173.7 billion; a 37.1%; Germany's was 86.0 billion, 16.2%; France's was 82.0 billion Euro, 15.5%; Russia, Spain, Italy, and Netherland followed, and these top 7 countries comprising 88% percent of total EU CBEC value.<sup>12</sup> European CBEC in 2017 was 534.0 billion Euro,<sup>13</sup> and 2018 forecast showed a constant growth from 2015, when it was 455.0 billion Euro<sup>14</sup>, as shown in Table 5.

*Table 5 European CBEC Value in Recent years, in Billions of Euro*

Year	2015	2016	2017	2018
<b>CBEC</b>	455.3	509.9	534.0	602(f)
<b>Inc.%</b>	-	12.0	4.9	12.7

Observing the data of 2018 in above table, we can derive that European people's average CBEC forecast was 692 Euro per capita, equivalent to roughly 5,465.13 yuan, according to the exchange on Dec 31 2018 (1 EUR = 7.8976 CNY)

*Table 6 Comparison of per capita CBEC between China and Europe in 2018*

Comparison	Europe	China
<b>CBEC in 2018</b>	602 billion EUR	9.7 trillion CNY
<b>Conversion 1</b> EUR=5,465.13CNY	4,53 trillion CNY	9.7 trillion
<b>Population</b>	0.87 billion	1.4 billion
<b>EUR Convert to CNY</b>	5,465.13 CNY	6928.6 CNY
<b>CNY Convert to EUR</b>	692.0 EUR	877.3 EUR

The result of the calculations from Table 6 show that China's per capita CBEC level, in 2018, was relatively higher than Europe's, roughly up around 21.12%, and it may infer that there could be fertile ground for some Chinese E-commerce firms to consider developing their business in Europe.

### 3 ANALYSIS OF HOME TEXTILE CBEC OPPORTUNITIES IN CEEC

In 2018, Central and Eastern European Countries (CEEC) and China shared the 16+1 platform, under the Belt and Road Initiative (BRI). CEEC covers 1.336 KM<sup>2</sup>, its population counts 160 million, with a GDP per capita in 2012 of 11,400 USD (2012)<sup>15</sup>, already slightly higher than Chinese last year's one of 64,644 CNY (about 10,000 USD in 2018).<sup>16</sup> As China exported 785.1 billion yuan worth of textile products, EU held 16.45% of China total exported goods, (China Custom Statistics Division director Li Kuiwen's report)<sup>17</sup>. If CEEC countries were put in a scenario similar to that of EU's trade with China, where Home Textile on average takes up about 30% of whole textile products, it could be hypothesized that CEEC countries would have a

<sup>12</sup> Web Journalist, Analysis of European E-Commerce Market and Prediction, China Industry Information Web, chyxx.com 2017 08 25

<sup>13</sup> eburnGo, European CBEC value is 534 billion Euro in 2017, Eburn.com, www.ebrun.com/ebrungo/zb/292998.shtml

<sup>14</sup> Ebur.com, 2016 European Ecommerce Market, <http://www.ebrun.com/20160927/194486.shtml>

<sup>15</sup> Sina web journalist, 16 nations' Economy population and GDP, 2015 11 24 [http://blog.sina.com.cn/s/blog\\_5ce1af980102vulh.html](http://blog.sina.com.cn/s/blog_5ce1af980102vulh.html)

<sup>16</sup> Li Keqing, China government work report at the opening meeting of the second session of the 13th National People's Congress in Beijing, March 5 2019

<sup>17</sup> Li Kuiwen, China exports to European Union in 2018, <http://finance.ifeng.com/c/7jSCVu58DQL>

Home Textile trade with China of roughly 12 billion yuan worth of market potential (see following last calculation).

This hypothesis is based on the following formulas and calculations:

- 1)  $A = \text{“China’s textile products export to EU”} = \text{“China’s textile product export”} \times \text{“China’s export to EU”} / \text{“China’s total export”}$   
 Substituting values, for 2018, units in 100 million yuan,  $A = 7,851 \times 27,000 / 164,177 = 1,291.15$
- 2)  $B = \text{China’s textile products export CEEC} = A \times \text{“CEEC population”} / \text{“EU population”}$   
 Substituting values, for 2017, units in million yuan,  $B = 129,115 \times 160 / 513 = 40,269.79$
- 3)  $P = \text{“Potential for China Home Textile export to CEEC”} = B \times 30\%$   
 Substituting values, from passage 2), units in billion yuan,  $P = 40.27 \times 0.3 = 12.08$

Proceeding on the same hypothesis, assuming that CBEC takes around 20% of total trade value, the Home Textile to CEEC would be worth about 4 billion yuan; averaged to CEEC population, would be only 25 Yuan per capita (less than 4 USD), compared with China’s 5,199 yuan per capita. Assuming that Home Textile constituted 1 percent per capita of online shopping in 2017 in China, i.e. 52 Yuan per capita (around 7.7 USD), it could be suggested that firms in Home Textile in retail, wholesale and E-commerce, in China and CEEC, may pay more attention to this particular potential scenario.

### ***E-commerce in Serbia***

Serbia is one of the countries included in the BRI and China + CEEC platform. It has a growing collaboration with China and presents a potential hub for CBEC in the Balkan region. In their 2019 eCommerce report<sup>18</sup> concerning Serbia, Statista (Statista, 2019), indicates that revenue in the E-commerce market amounts to 354 million USD, with expected annual growth rate (CAGR 2019-2023) of 9.6% and a market volume of 510 million USD by 2023.

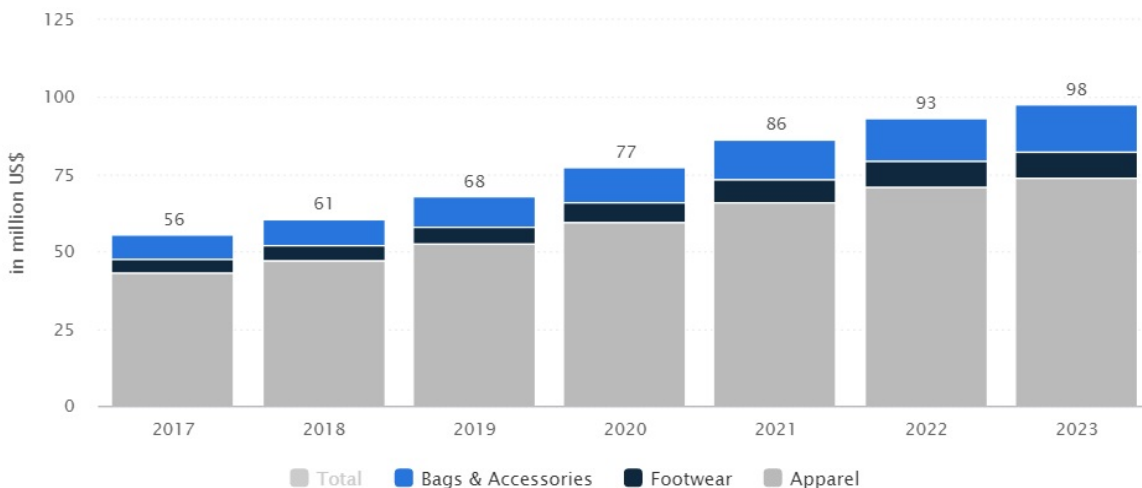

*Figure 1: Revenue in E-commerce Fashion market in Serbia, source: Statista, February 2019*

As presented in Figure 1, the Fashion segment revenue in 2019 amounts to 68 million USD with expected an annual growth rate (CAGR 2019-2023) of 9.4%, resulting in a market volume of 98 million USD by 2023.

<sup>18</sup> Statista Digital Market Outlook - Market Report, eCommerce Report 2019, Released: December 2018, <https://www.statista.com/study/42335/e-commerce-report/>

The market's largest segment is Apparel with a market volume of 52 million USD. User penetration is expected to hit 50.7% by 2023. The average revenue per user (ARPU) currently amounts to 87.18 USD, according to Statista (ibidem).

Some of the local online shopping platforms in Serbia are shopmania.rs, winwin.rs gigatron.rs, kupujemprodajem.com and limundo.com, while aliexpress.com is also used. Other top retail sites include kupindo.com and haloglas.com. According to the Development Agency of Serbia, Textile industry is quite relevant in Serbia, employing more than 250,000 workers and exporting more than 5 billion USD, with 1,800 active companies (RAS 2019).<sup>19</sup>

#### **4 SUGGESTED CBEC STRATEGY IN HOME TEXTILE THROUGH UNIVERSITIES**

Considering the case of the DSQ Park and the potential of Serbia as a CBEC hub in the Balkan, and perhaps even wider CEEC region, as far as Textile industry (Home Textile as a special case) and E-commerce are concerned, a three parts strategy is proposed:

- Through existing academic cooperation between China and Europe, Universities that have

Textile research centers or are oriented towards Textile industry, such as Donghua University in Shanghai, China, and Novi Sad University in Serbia, can cooperate on researching issues in CBEC between China and Serbia, providing solutions and best practices that can be applied in real business case scenarios in both countries.

- Depending on issues being tackled, the Universities can ask for involvement and support from local governments and other entities, such as business associations or chambers of commerce, following the example of Triple Helix "University-Industry-Government" Model<sup>20</sup> with focus on identifying local E-commerce platforms that could lead the (Home) Textile CBEC.

- In case there are no existing E-commerce platforms that can take on the role of CBEC leaders in Textile industry, the research link between the selected Universities could serve as a fertile ground for a joint Incubator that would grow future E-commerce platforms specifically designed for Textile industry; study of real business cases such as DSQ Park could provide precious insight and guidance.

(Thanks to Jiangsu Haimen Industry Park Management Committee's great support for related data and assistance to our investigation!)

#### **REFERENCES**

<sup>19</sup> RAS, Development Agency of Serbia, 2019 <https://ras.gov.rs/textile-industry>

<sup>20</sup> Stanford University, The Triple Helix Concept, Triple Helix Research Group. 11 July 2011. [https://triplehelix.stanford.edu/3helix\\_concept](https://triplehelix.stanford.edu/3helix_concept)

# ANALYSIS ON GUIZHOU'S TRADITIONAL CRAFT BRAND BUILDING

Meiqun Na<sup>1</sup>, Guoxiang Yuan<sup>1,2\*</sup>

<sup>1</sup>College of Fashion and Design, Donghua University, Shanghai, 200051, P.R. China

<sup>2</sup>Key Laboratory of Clothing Design & Technology, Ministry of Education, Shanghai 200051, P.R. China

\* Corresponding author, Dr Guoxiang Yuan is an Associate Professor in College of Fashion and Design, Donghua University. His research areas focus on fashion and textile design, design approach and clothing technology. Email: [vogue@126.com](mailto:vogue@126.com)

## Abstract

*This article takes Guizhou traditional craftsmanship as an example to understand its status quo and needs, combined with the background of its existence, from the aspects of brand culture, product manufacturing, operation mode, brand promotion, etc., gives a brief analysis of the key points in Guizhou's traditional crafting brand creation. It is hoped that we can give some references to those insightful people who are interested in inheriting and protecting Guizhou's traditional crafts, and further promote the traditional craftsmanship of Guizhou to build a brand, and then continue promoting the craftsmanship and culture of our country.*

**Keywords:** Traditional craft; Brand Building; Guizhou

## 1 Introduction

Guizhou's traditional crafts are rich in regional features and local flavors. Their artistic value is extremely high, but with the changes in society and people's lifestyles, it causes tremendous impacts on traditional crafts. Under this circumstance, traditional crafts in Guizhou are in urgent need of transformation.<sup>[1]</sup>

Because of the rapid development of productivity, the complexity of the traditional process, so with the development of large-scale industrial production, machining gradually began to replace traditional production methods. The technicians of traditional crafts in Guizhou have no propaganda awareness due to their own cultural background and limitations. At the same time, it faces severe inheritance problems. The technicians of traditional crafts in Guizhou have not pay much attention to the promotion of culture and related craftsmanship. Secondly, with the developing tourism, in order to cater to the needs of a large number of tourists, some so-called handicrafts reduce the quality of products, lack of design sense, and blindly follow the trend.<sup>[2]</sup> As a result, some traditional crafts in Guizhou have become more difficult. Therefore, promoting traditional crafts in Guizhou to build brands has become an urgent problem to be solved.<sup>[3]</sup>

This article is to give some suggestions on the establishment of a brand, so as to promote the development of traditional craftsmanship. The article found that relevant policies, experience economy, aesthetic economy, and cultural and creative industries are all available background conditions.

## 2 Background

### 2.1 Related policies and protective measures

Judging from the country's orientation, in 2015, "the Belt and Road" exhibition area of China International Cultural Industries Fair (ICIF) featured arts and crafts were highly favored; In 2017, national handicrafts along the Belt and Road line gather in International Festival of the Intangible Cultural Heritage, Chengdu, China; In August 21, 2017, Belt and Road Forum on International Cooperation and Exchange in Cultural Heritage held in Beijing. Recalling the history of the export of porcelain and silk, the Silk Road is a key bridge for the economic and humanities of all countries.

The Belt and Road policy will usher a new pattern of traditional craft development and bring new energy to traditional craftsmanship. At the same time, in 2017, the "craftsmanship spirit" was included in one of the 90 new terms that must be mastered by former public officials before the 19th session of national congress of the communist party of China.

To inherit the spirit of craftsmen and upgrade China's manufacturing, it is necessary to cultivate and protect national masters of craftsmen, which is the inevitable requirement of China from "made in China" to "Design in China".

Judging from the development of the province, in 2017, Ethnic and Religious Affairs Commission and Federation of Literary and Art Circles of Guizhou province will name 1,000 provincial minority traditional craft workshops from 2016 to 2020. And combined with the provincial government's industrial development policy to support the development, so as to form a prominent feature of traditional ethnic handicraft heritage bases to promote the healthy development of traditional ethnic handicrafts.<sup>[4]</sup>

## 2.2 Experience economy and aesthetic economy bring opportunities

Since the industrial development so far, consumers have gradually paid for the company's ideas and products. The ingenuity design and detail creation of the merchants allow consumers to deeply experience the product production process, arouse the inner resonance, recognize the corporate culture, and become loyal customers of the company. This is the so-called experience economy.

At the same time, the lifestyle of modern people has changed, and the "pursuit of beauty" as a consumer demand has enabled visual design to gradually become a product of competitiveness. In a market dominated by aesthetic economy, From product design to marketing, the unity of visual style will give consumers deep recognition and trust.

Even taking the consumption of products as a way of demonstrating self-worth, it can be seen that the aesthetic economy has brought opportunities.<sup>[5]</sup> (Fig. 1)



Fig.1 Shanghai Pehchaolin double 11 custom gift box

## 2.3 The trend of cultural and creative industries is further rising

Cultural industry market share continues to grow, becoming a general trend. Although China is a big country with a large cultural resources, it is not a strong country with a cultural and creative industry. In 2014, Zhang Gang pointed out that the problems in the development of China's cultural and creative industries are due to the fact that corporate technology is not advanced and social participation is not high.<sup>[6]</sup> Xiao Yanfei and others believe that training talents in the cultural and creative industries is the key. In the same year, taking Chinese style fashion photo gallery "Panzi woman workshop",<sup>[7]</sup> He Jingxue proposed the idea of three steps to create a cultural and creative industrial chain.<sup>[8]</sup> As a treasure trove of cultural resources, Guizhou traditional craftsmanship has great potential for developing brands into cultural and creative industries.



**3**

**3.1 Brand culture**

Giving brand culture can arouse consumer's emotions and values, gain resonance, become brand beliefs and loyal consumers, and the consumer team like “cultural advocates” has become increasingly large. Another example is the daily wearable Chinese luxury brand "HUAMUSHEN", the soul of brand culture, is the love of classical aesthetics essence. The brand strives to be a guide for fashion and classics, using classical charm to incorporate the elegant elements with modern fashion for women.<sup>[9]</sup> (Fig. 2)



*Fig.2 HUAMUSHEN Design Theme and Culture*

The best expression of brand culture is the brand story. For example, “a story you never knew” about NONGFU SPRINGS' search for good quality water sources tells the story of the brand. Bring the distance between the brand and the public closer, subtly conveyed the brand culture, and formed a brand influence. The traditional craftsmanship brand in Guizhou should start with the brand story and let the world listen to the craftsman's life story and the ancient work from generation to generation.

The natural scenery and local customs of each ethnic township are made clear in the minds of consumers, so that the brand culture can be traced in a detailed way.

**3.2 Product manufacturing**

**3.2.1 the inheritance and improvement of the design**

The difficulty of product design of Guizhou traditional craft brand lies in the choice of traditional elements. Taking Miao embroidery as an example, the specific image and symbol decoration in Miao embroidery often represent a story, a yearning, a belief and a history. It is not only the symmetrical aesthetics of geometry, but also the formal aesthetics of image. Many brands tried to implement Miao embroidery on clothing, but most of them did not meet the modern aesthetic sense. And the designer brand "HUAMUSHEN" of the Miao embroidery series, in the inheritance and improvement, reconstructs the unique signs in the Miao embroidery, as if the Miao culture and the Chinese ancient culture are closely intertwined, and recount the long and long ancient legends (Fig. 3). Therefore, the focus of Guizhou traditional craft design products is to deconstruct and reorganize, extract traditional elements, combine modern aesthetics, and create brand image in the process of inheritance and improvement.



*Fig.3 Miao embroidery series of HUAMUSHEN*

Nowadays, a number of independent original designer brands are emerging, which are different from the unique design of the popular brands, and are attracting the attention and attention of the new generation of consumers. The traditional crafts brand in Guizhou can cooperate with such brands and designers to make the traditional design open the pattern of innovation and seek new development in the inheritance and improvement.

### 3.2.2 the inheritance and improvement of the process

The complex traditional process has lengthened the production cycle, unable to meet the demand of modern "fast consumption", and decided to improve the process to meet the needs of the modern public. In the industrial age, the handicraft is either gradually disappearing or transformed into a symbol of a luxury lifestyle. "NE.TIGER" is a typical Chinese luxury brand that can not be separated from embroidery.

In addition, the 2017 spring and summer series, designed by "Grace Chen" founder Chen Yehuai, deconstructed and reorganized the Miao embroidery, making the traditional craft no longer a vanishing display in the museum window, and truly integrated into the modern clothes. (Fig. 4)

"The real way to protect handicrafts is to make them truly used for life." Only the improvement of the production process, the traditional crafts can truly integrate into life, and Chen designers have also combined with the Western draping. The traditional handicraft products in Guizhou need to be in line with the market and occupy a specific market. Design, process and technology need improved from the perspective of mass market to achieve high efficiency and high quality. With the cooperations of above factors with relevant technicians and experts, we will leave valuable information for future generations.



*Fig.4 Miao embroidery series of Grace Chen*

### 3.3 Operation mode

The key to the operation of traditional craft brand lies in retaining the traditional technology and expanding its scale. The traditional handicraft is generally developed in the villages and towns. The brand operation needs to build regional characteristics, gather local culture, promote the construction of the characteristic town, and form a scale economy. In the past, the operation mode was easy to enter the misunderstanding of single sightseeing, too superficial, and caused the competition of handicraft dumping competition. The new model should be injected into the humanistic feelings, contact the local handicraftsmen to enter the enterprise, hold workshop exhibitions, auction of handicraft, explain local culture, and close the distance to the consumers.

Meet the experience economy, join teaching experience activities, open production chain visits, inspire consumers' sense of innovation, solicit consumer ideas, integrate arts and crafts design, and discover the use of arts and crafts. Experiential interaction has won the recognition of consumers and also opened up new ideas for brand product design. To cater to the aesthetic economy, the coalition government, associations, and residents should combine unique landscapes, design public facilities, and form arts and crafts commercial streets to create cultural parks. The formation of clean, unique, artistic and quaint towns, enhance corporate image and bring trust to consumers.

Such as Taiwan Warbler song ceramics, the establishment of " Warbler Song Ceramics Art Development Association", the " Warbler Song Ceramics Carnival", the joint government departments to transform "

Warbler Song Ceramics Old Street", the establishment of " Warbler Song Ceramics Museum", this regional operating model, makes Yingge Ceramics a spokesperson for local culture. (Fig. 5)



*Fig.5 Warbler Song Ceramics Museum*

### 3.4 Brand promotion

#### 3.4.1 Mainstream media

The state pays more and more attention to the protection of traditional technology, which can be reflected from the propaganda of mainstream media. Check out the CCTV hot program from 2012, " A Bite of China ", "Great Craftsman" in 2013 to "Amazing Chinese" in 2014. We have witnessed the craftsmanship of our craftsmen in China and their Chinese dream. For example, Li Xintong, an Ebru artist in the third quarter of "Amazing Chinese", put on the "magic" on the water, and brought home the thousands of ancient techniques of the Silk Road, which caused a sensation. (Fig. 6) Guizhou's traditional craft brands can actively seek cooperation with mainstream media, expand brand influence and arouse the sense of national responsibility of the masses.



*Fig.6 Li Xintong and Ebru*

#### 3.4.2 New media

In the age of new media information, all kinds of social networks, video platforms, and mass media have risen. The audience has more information ports, the choice of autonomy is strengthened, and the brand has more ways of publicity, and the possibility of "shielding" is also greatly improved. The old "broadcast" propaganda effect is getting weaker and weaker, and the new "conversation type" propaganda effect is stronger and stronger. Corporate propaganda is not only a simple "to consumers", but rather to "talk with consumers". Experience economy determines the "experiential" communication. The focus of brand publicity should not be enterprises, but consumers.

The traditional craft brand of Guizhou should use new media technology and platform to convey brand concept, humanistic sentiment, aesthetic taste and life attitude, so as to strike the heart of the consumer directly. Consumers from brand recognition to identification and trust, so as to share the publicity and purchase of products, the value of brand publicity as a spokesman for their values, further spread, drive the same type of people, to form a lasting effect. Such as the "See The Love" art exhibition held in 2009 by Taiwan Franz, a series of publicity videos of old husband and old wife, mountain climbing brothers and father and daughter were released on Youku to let the audience feel the full brand culture. In addition, the activity website, MSN and press conference carried out propaganda in all directions, resulting in the great public opinion effect. Taiwan Franz became famous from this (Fig. 7).



*Fig.7 the "See The Love" art exhibition*

### 3.4.3. Other

In the end, the traditional craft brand is different from other brands because it has the privileges of national related policies and protection measures, as well as the urgent need for the construction of cultural industry chain, therefore, branding of traditional crafts in Guizhou can be linked to politics and education. For example, in international activities, Peng Liyuan used ZTE mobile phones and dressed designed by local brand "EXCEPTION de MIXMIND" are well received by domestic and foreign fashion media.

At the same time, the SPDC skin care gift boxes made of Chinese elements and the Sichuan embroidery of panda designs are presented as "national rites". (Fig. 8).



*Fig.8 Peng Liyuan leads the "First Lady Effect"*

## 4 Conclusions

Traditional crafts in Guizhou are the most precious treasures of Chinese traditional culture. The way of inheritance and development traditional craft with modern design becomes one key factor for the creation or development of a brand. At present, the cultural and creative industries have further risen, and experience economic and aesthetic economies have brought opportunities, and domestic related policies and protective measures have been introduced. We believe that as long as the key points for creating a brand are well dealt with, a brand culture is built, inheritance and improvement of design and craftsmanship, modern product manufacturing, joint efforts to create regional features, introduction of advanced management systems, clever use of the media for brand promotion and forming brand influence, then the traditional craftsmanship brand in Guizhou will become the guide for China's creation, a spokesperson for China's fine arts and a successor to Chinese culture.

## Acknowledgments

This research was supported by “the Fundamental Research Funds for the Central Universities - 18D110713” and “Shanghai Summit Discipline in Design - DD18001.

## References

- [1] Wang Min, Yang Xiaoyuan. Study on the Inheritance and Development Opportunities of Traditional Handicrafts of Guizhou Minority Nationalities [J]. *Border Economy and Culture*, 2015 (9): 5-6.
- [2] Liang Taihe. Guizhou traditional crafts and tourism development [J]. *Guizhou ethnic studies*, 1995 (4): 127-138.
- [3] Zhang Jianshi. The Change and Cause Analysis of Traditional Miao Traditional Silverware Process in Southeast Guizhou: A Case Study of Tonglong Village and Leishan Qiaobai Village in Taijiang, Guizhou Province [J]. *Ethnic Studies*, 2011 (1): 42-50.
- [4] Guizhou Provincial Ethnic Religious Affairs Commission. Guizhou protects ethnic minority traditional craftsmanship in inheritance [J]. *Chinese nation*, 2017 (2): 61.
- [5] Wei Jing. *The Regeneration and Innovation of Traditional Craft Brands under the Style of Society* [D]. Suzhou University, 2013.
- [6] Zhang Gang. China's cultural industry development status and approach [J]. *Business*, 2014 (8).
- [7] Xiao Yanfei, Wang Yuyun, Wan Zijie. The Influencing Factors and Empirical Research on the Development of Chinese Cultural and Creative Industries[J]. *Science and Technology Management Research*, 2014(11).
- [8] He Lu snow. The Assumption of the Construction of Cultural and Creative Products into the Cultural Industry Chain——Taking China Wind Trend Photo Gallery as an Example [J]. *Industrial Economics*, 2014 (11):170-172.
- [9] Li Yonggang. Research on the Combination of Traditional Handicraft and Modern Technology——Taking Xinhua Village as an Example of “Hometown of Chinese Folk Art” [D]. Kunming University of Science and Technology, 2009.

## DUAL EDUCATION

**PhD Gabrijela Grujić**

Assistant Minister Ministry of Education, Science and Technological Development, Republic of Serbia,  
mail: [gabrijela.grujic@mpn.gov.rs](mailto:gabrijela.grujic@mpn.gov.rs)

One of the priorities of the Government of the Republic of Serbia in the field of education, youth employment and economic development is dual education. Dual education is defined as part of system of vocational education and training through theoretical and school-based teaching and work-based learning at employer, they acquire, develop and build knowledge, skills, abilities and attitudes in accordance with the standard of qualification and the curriculum.

The advantages of dual education are reflected in the fact that students will be experts in some field immediately after finishing vocational school, and their knowledge will be in accordance with technological development. They acquire all the competencies needed for modern innovative progress, in order to be entrepreneurial, develop social skills and think proactively.

In 2017 Republic of Serbia adopted the Law on Dual Education which introduces dual education into formal system of education as a model for realization teaching in the system of vocational education and training. Three rulebooks were finalized. Rulebook on training programs for instructors and conditions for taking exams for instructors, Rulebook on the method of allocating students for work-based learning, Rulebook on detailed conditions of work methods with activities and the composition of the team for career guidance and counseling of students in dual education. The Serbian Chamber of Commerce has adopted the Rulebook on the organization, composition and working methods of the Commission for determining the fulfillment of conditions for the performance of work based learning at employer. The full implementation of the Law begins with the 2019/2020 school year, until then, all the necessary conditions for the quality implementation of the Law are being prepared. Beside 3 aforementioned rulebooks, the Chamber of Commerce started training of instructors, actually employees of companies who directly provides that during learning throughout work-based learning realization of the contents prescribed by curriculum. The Government of the Republic of Serbia established the Commission for the Development and Implementation of Dual Education for the implementation and improvement of dual education and a three-year evaluation of the achieved results.

Implementation of the dual model of higher education studies has been initiated and the Draft Law on dual model of higher education studies has been drafted with the aim of increasing the relevance of higher education and the employability of graduated students, modernization of the teaching process in cooperation with the economy and in accordance with modern technological achievements.

This type of realization of teaching implies direct involvement of employers in the organization and implementation of work-based learning in a real working environment.

The draft law on dual model of higher education studies envisages that students with an employer conclude a contract on work-based learning. Student work is not classical work, but learning through work where they acquire the skills they need to improve their competencies.

The essence is to learn a job, and the employer depends on whether the graduate will be hired even after completing the studies. Employers will not be allowed to hire students for jobs that don't match their profession.

Work-based learning in the employer's premises carries a certain number of ESPB points. Students will have to decide whether they want dual education or standard study courses before their enrolment at faculties, and faculties can allow with regulations that a student which select dual education return to the standard way of studying and opposite - that the one who has decided to go for a standard study switch to dual education.

Young people through this form of education, although more demanding and more difficult, acquire, among other things, practical skills and skills that will enable them easier transition to the world of work, as well as competencies for career management, lifelong learning and entrepreneurship. This form of education enables employers to participate in the formal education of future staff and reduce costs in the long run due to search for qualified personnel.

In Serbia currently approximately 23% of all vocational schools implementing at least one dual educational profile, and at the beginning of the next school year, that number will reach 30%. Currently, there are about 38 dual educational profiles in the system, created in close cooperation with employers. The total number of students in dual education is 4500, and another 3156 students are expected to enroll, and around 600 companies have expressed interest in conducting their work-based learning for students who have enrolled dual educational profiles, this year 460 of them expressed desire to participate in dual education system, which means that they will obey the Law on dual education that will be implemented from the school year 2019/2020.

Areas of work where educational profiles are located are:

**agriculture, food production and processing, forestry and wood processing, geology, mining and metallurgy, mechanical engineering and metalworking, electrical engineering, textiles and leather, geodesy and construction, traffic, trade, catering and tourism.**

The Ministry of Education, Science and Technological Development intensively in cooperation with domestic and foreign partners, respecting the principles of social partnership, developed the Master Plan for the development and implementation of dual education, is currently working on the realization of promotional activities as well as on the development of a methodology for the implementation of dual education and the development of a monitoring framework and evaluation of dual education. The first analyzes will be done when conditions are met, that is, when the first generation of students completes their education by the dual education system and enter the labor market.

## **TRENDS IN DIGITAL TEXTILE PRINTING DEVELOPMENT TECHNOLOGICAL PROCESS**

**Marko Marinkovic, Vladimir Milakovic**

Sitotehnika - Mimaki, Japan

[sitotehnika@gmail.com](mailto:sitotehnika@gmail.com)

### **SUMMARY**

Contemporary the line for pre and post-treatment of digitally printed fabrics includes coating, printing steaming, washing, drying and color fixation.

### **QUOTATION**

Coating is a compact unit for pre-treatment and drying of fabrics up to 180 linear meters/hour. The coater/dryer is designed to work in combination with the most advanced textile inkjet printers up to 1.8 meters using both reactive or pigmented inks. Thanks to its compactness, versatility, ease-of-use and fast turnaround times, it can be installed in any production department and can serve one or more inkjet printing units.

### **MATING**

Steam unit is in the forefront of the textile printing industry. Thanks to its long-standing experience in textile pre-treatment and finishing plants. Steaming requirements of professional users in the clothes, linen and soft signage industry. The steaming process produced by steam is comparable with the chemical process normally achieved at dyeing plants. It's suitable for a wide range of fabrics printed using reactive ink chemistries on the most popular textile inkjet printers. Even if powerful and highly-efficient, steam doesn't work under pressure and it stands out for its ease-of-use and easy integration within existing workflows, even if operated by inexperienced employees. When installed at digital printing plants and service shops, steam uses the steam produced by its own steam generator, powered by the electrical system. The water utilized in the steaming cycle is regular tap water. The entire steaming cycle, regulated by an automatic timer and steaming pre-sets, ensures excellent results, stability of printed fabrics and unattended production except for loading and unloading operation. According to customers' requirements, steam is designed to easily answer the fast growing needs of production speeds, versatility and quick turnaround times. Each steam unit can load up to 50 meters of fabric per cycle, with an average productivity up to 600/700 linear meters/day on a single shift, depending on fabric's type and weight. More steam units, all managed by one operator, can be placed side-by-side in order to follow the growing steaming requirements of printing companies running multiple inkjet printers.



## WASH

Wash is the most innovative system for professional washing designed for small and medium volumes of digitally printed fabrics. Thanks to its extraordinary compactness and versatility, wash can be easily installed into any production department in combination with one or more textile inkjet printers using reactive inks, acids or any other ink chemistry that needs washing. Enables wash to wash reels of fabric up to 100/150 meters of diameter (variable depending on the weight of the fabric) in reduced spaces and with the highest ease-of-use.

**Minimized consumption of water, electricity and detergent** wash is designed to minimize the consumption of primary goods, first water and electricity. Thanks to a water supply system with separate reservoirs at different temperatures and with high thermal stability, the electricity consumption is drastically reduced compared to conventional systems. The sophisticated control interface and the ability to define process presets, guarantee short and precise operations, allowing you to use only the minutes, liters, watts and the doses of detergent strictly necessary to wash the required meters of fabric. **Automation, precision and digital control** wash is built with quality materials and standards of the highest level in the mechanical, hydraulic and electronic components, which ensure full productivity and reliable 24/7 operations. Like the other modules of the workflow, even wash can be driven either on the machine or remotely via a simple and intuitive touchscreen interface. The practical loading system of the reel and the possibility to use and make presets allows even less experienced operators to complete the washing cycle and download the reel for subsequent drying. **Modularity and productivity for growing printing volumes** wash is designed to meet both the needs of the small digital print shops, as the growing volumes of customers with medium and large installed bases. Washer can in fact accommodate reels of printed fabric up to 250 mm diameter and make more washing cycles per hour. The full protection of the investment is guaranteed by the availability of models of up to 1,8 meters in width, which may however accommodate smaller reels thanks to the practical variable width loading system. This permits the use of a single wash unit even in the presence of different printers' size in the company.

## REWINDING BETWEEN THE PROCESS

Wind is a powerful motorized high-precision unwinding/rewinding coupling designed specifically to wind and rewind all kind of fabric reels, wrapped on a metal or a cardboard core-roll, and combining or separating them by a second or third layer of separation material for the further operations of steaming, washing and drying/fixation.

Designed to meet the precision, productivity and versatility needs of textile inkjet printing, easyWIND is an integral part of the workflow and is designed to operate independently or in combination with the steaming unit, washing unit and the multi-functional coat/dry drying, fixation and pre-treatment units.

Wind unit is also equipped with a powerful compressed air system for the removal of the water in excess from the coil after washing and before the drying phase.

**Automation, precision and digital control** wind unit is built with the highest quality materials according to the highest standards, and is equipped with high-precision motors, which provide a perfect sandwich of fabric and separation material, thanks to the perfect control of the tension and alignment. Like the other modules of the workflow, even wind unit can be driven either on the machine or remotely via a simple and intuitive touchscreen interface. The ability to use and set the presets allows even less experienced operators to wind and unwind any type of fabric for the subsequent phases of steaming, washing and drying.

## **MODULARITY AND PRODUCTIVITY FOR GROWING PRINT VOLUMES**

Wind unit is designed to meet both the needs of the small digital printing business, and the growing volumes of medium and large installed bases and can in fact accommodate reels of printed fabric up to 250 mm diameter and operate up to 40 linear meters per minute. The full investment protection is guaranteed by the availability of models up to 1.8 meters in width, which may however stay smaller reels thanks to the practical variable width system.

## **MODERN MACHINE FOR PRINTING**

The following picture shows a modern printing machine.



*Belt – type Direct Textile Inkjet Printer*

## **CONCEPT**

Tx300P-1800B direct-to-textile printer is designed to meet demands for the ability to quickly accommodate on-demand production of high quality textiles for sample to smaller lot production;

Its compact size allows this model to fit perfectly in facilities with limited floor space, such as design studios or educational establishments. Also, this is an ideal solution as a sample making printer for large textile companies;

5 different inks are available to meet demands for different types of fibers

## **LITERATURE**

Technical information from Mimaki, 2019.

## DYEING PERFORMANCE COMPARISON OF SOYBEAN FIBERS WITH DIRECT DYES WITH CONVENTIONAL AND MICROWAVE TECHNOLOGIES

Ece Kalaycı, Arzu Yavas\*, Ozan Avinc, Tugce Tonguc

Pamukkale University, Faculty of Engineering, Textile Engineering Department, Denizli /TURKEY 20160  
e-mail [aozerdem@pau.edu.tr]

### ABSTRACT

*Energy conservation has a critical role in sustainable future for both economic and environmental aspects. The development of manufacturing methods requiring less energy has become a necessity for every industry, especially for the textile industry. The textile industry is one of the most polluting industries in the world. Particularly, textile coloration processes in the textile industry are the main processes requiring high energy and excessive water consumption. In this study, dyeability of soybean fibers with direct dyes under microwave energy was investigated. Colorimetric properties rub and washing fastness of soybean fabrics after microwave dyeing was compared with conventionally direct dyed soybean fabrics. Hereby, it has been found that the soybean fibers can be effectively dyed with direct dyes in a traditional way. Microwave dyeing of soybean fibers with direct dyes is acceptable but not as much effective as traditional dyeing.*

**Key words:** Soybean fiber, direct dye, microwave, energy saver dyeing

### INTRODUCTION

“Sustainability” has become a very important concept for today's industrial manufacturing. Time and energy saving methods have a great potential in a view of sustainable production approach for each industrial field. The textile industry is one of the most polluting industrial fields in the world. Therefore, time and energy conservation have a critical role in sustainable textile future for both economic and environmental aspects. Especially textile wet processes consume very high amount of water, chemical and energy in addition to their long period process durations. There are many researches and studies aiming to reduce energy consumption in the textile industry and decrease production processing times. The use of microwave technology in textile manufacturing is one of these innovative research areas.

Microwaves which have broad frequency spectrum are electromagnetic waves (wavelength ranging between 1cm and 1m) that can be used in various sectors such as food, chemistry, textile, metallurgy, ceramic and furniture (Büyükkıncı, 2012; Özerdem, Tarakçıoğlu, & Özgüney). The applicability of microwave technology in the textile industry covers a wide area such as heating, drying, condensation process, dyeing and printing, finishing processes, surface modifications of textile materials (Yavaş, Kalaycı, Avinç, & Aras, 2017; Montazer & Alibakhshi, 2007). Although the use of this technology in the textile industry saves time and energy, it has not yet been widely used in the textile industry globally (E Kalaycı, Avinc, Yavas, & Coskun, 2019).

Microwave heat mechanism is composed of three main units named as magnetron, waveguide and applicator. Electric energy is converted to microwave energy and this energy is drawn to the water load (Büyükkıncı, 2012). Heat energy is generated by the vibrations of water molecules. Fast, uniform and efficient heating can be achieved by the simultaneous penetration of microwave energy to all particles in the structure of the material.

While the heating in the conventional heating methods takes place from the outside to the inside, the direction of the heating with the microwave energy is outward from the center of the material (Figure 1). Researches for the use of microwave energy in the dyeing of various fibers confirm the usability of this method in textile dyeing processes. In this study, the dyeability of soybean fibers with direct dyes under microwave energy was investigated.

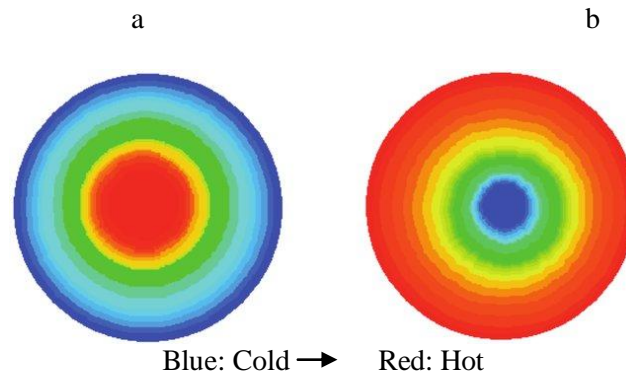

*Figure 1: Microwave heating (a) moves from central to outer surface while conventional heating (b) moves from outer to the center (Salema & Ani, 2012)*

## DYEABILITY OF SOYBEAN FIBERS

Soybean fibers, a protein based regenerated fiber, have a wide usage area with their soft, shiny, smooth, draped and sun-resistant structure. They are particularly preferred in the production of baby and child products (Yildirim, Avinc, & Yavas, 2015; Avinc & Yavas, 2017). Soybean fibers are mostly dyed with acid, chroma, metal complex and reactive dyes due to their protein-based nature (Ece Kalayci, Yavas, Avinc, & Bektas, 2018). The previous studies indicate that soybean fibers can be dyed easily using reactive dyes and acid dyes via conventional dyeing methods, and exhibit good washing fastness properties (J. h. Choi, Kang, & Yoon, 2005). Natural dyes are also stated as other natural option for dyeing process of soybean fibers (H. Choi, Shin, Choi, Kim, & Chung, 2007; Noh & Lee, 2014).

A large proportion of direct dyestuffs are in the disazo and polyazo molecular structure and in the water-soluble dyestuff group. Direct dyestuffs do not contain functional groups that can react with fibers, so they have only bound to the fiber with weak H-bridges. Therefore, these direct dyes exhibit low fastness properties. However, it is possible to improve fastness properties utilizing post-treatments. Moreover, direct dyes are widely used in textile dyeing industry due to their ease of applicability and low cost (Clark, 2011; Aspland, 1991). In this study, dyeability of soybean fibers with direct dyes was investigated utilizing microwave energy and conventional method.

## MATERIALS AND METHODS

In this study, 100% soybean fiber single-jersey knitted fabric (fabric weight of 110 g/m<sup>2</sup> and yarn count of 30/1, whiteness degree 36,87 Stensby) was utilized for coloration via dyeing.

### Dyeing operations

As earlier indicated soybean dyeing were performed with conventional and microwave exhaustion methods with 2% direct dyestuffs [Solophenyl Blue FGLE, Solophenyl Scarlet BNLE (Huntsman)].

All dyeing methods were carried out with 1:60 liquor ratio accompanying 20 g/l sodium sulphate and 40 g/l sodium carbonate by using Atac Lab-Dye HT laboratory type dyeing machine. The dyeing procedure was given in the Figure 2.

Microwave energy assisted dyeing process was carried out using Arçelik MD 565 model microwave oven (900 watt) for 3,5,7,9 minutes via exhaustion process. Dyeing liquor was prepared at room temperature and poured into closed glass container. Dyeing liquor was completely evaporated in the prolonged applications than 9 minutes; therefore, longer durations could not be studied.

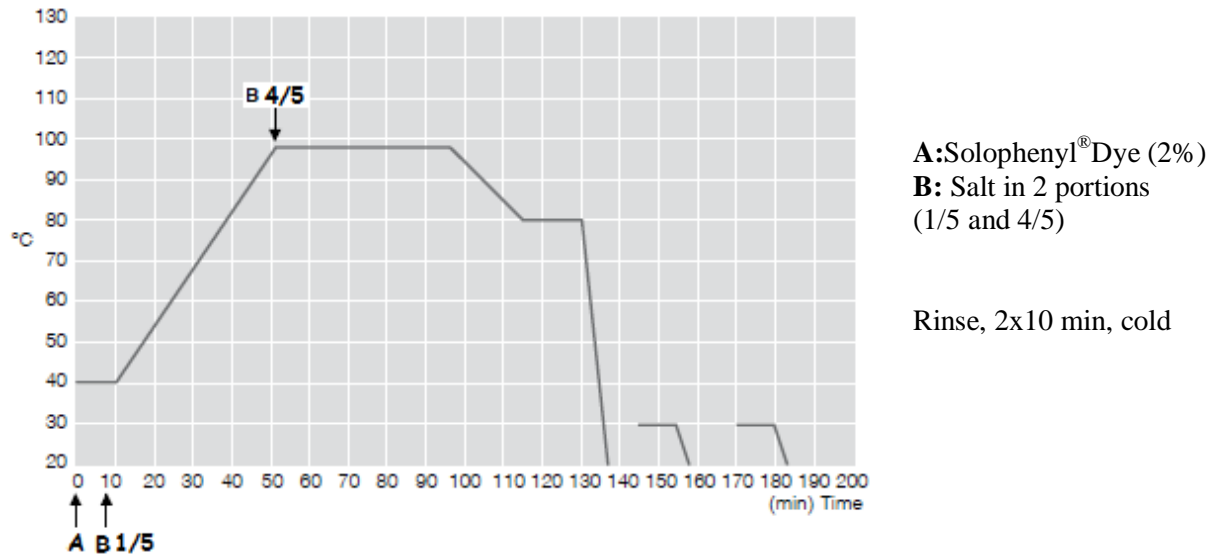

Figure 2: Conventional exhaustion dyeing profile for the Solophenyl<sup>®</sup> direct dyes

After each dyeing process, samples were cold rinsed for 10 minutes (2 times for 10 minutes) then air-dried. Washing and neutralization were applied to the samples after dyeing process following to rinsing. Soybean fabric samples were air-dried at the end of the dyeing, neutralization and post washing processes. Afterwards, cationic post-treatment was applied to dyed soybean fabric samples with ALBAFIX<sup>®</sup> ECO (2%) in order to enhance color fastness properties of direct dyed samples. Application steps of cationic post-treatment were given in Figure 3.

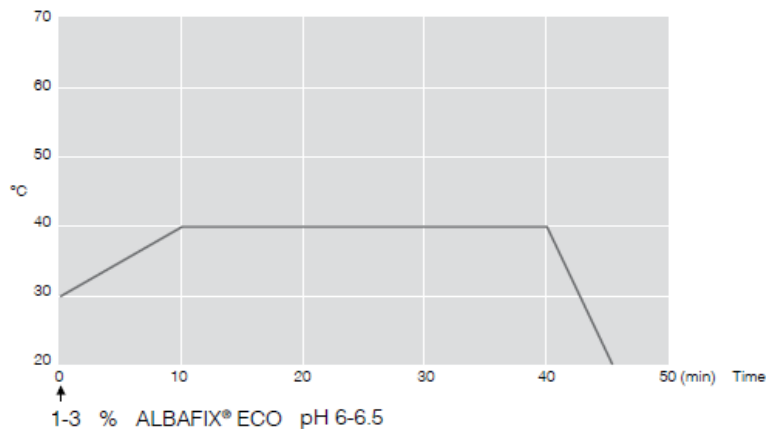

Figure 3 Application of Albafix ECO (Huntsman)

## Colorimetric measurements

The color properties of direct dyed soybean fabric samples were measured and calculated according to CIE  $L^*$ ,  $a^*$ ,  $b^*$ ,  $C^*$  and  $h^\circ$  co-ordinates by using a Datacolor SpectraFlash 600 (Datacolor International, Lawrenceville, NJ, USA) spectrophotometer (D65 day light, 10° standard observer). Each fabric sample was folded as being 4 plies and was read in four different areas, and the average value was calculated.

## Color fastness tests

Washing fastness and rub fastness properties of direct dyed soybean fabric samples were investigated according to the ISO standards. Washing fastness to domestic laundering (C06) was carried out according to ISO 105:C06 A2S test (40°C) in a M228 Rotawash machine (SDL ATLAS, UK). Both dry and wet rub fastness testing was performed following the ISO 105: X12 protocol.

## RESULTS AND DISCUSSION

### Colorimetric properties

The colorimetric properties of direct dyed soybean fabric samples were given in Figures 4-7 and Tables 1-2. The reflectance percentages of Solophenyl Scarlet BNLE and Solophenyl Blue FGLE direct dyed soybean fibers are shown in Figure 4 and Figure 5, respectively. The reflectance spectra of conventional direct dyed samples were compared with that of microwave assisted direct dyed samples. The closest reflectance spectra to conventional dyeing have been obtained in 9 min microwave assisted dyeing for both direct dyes.

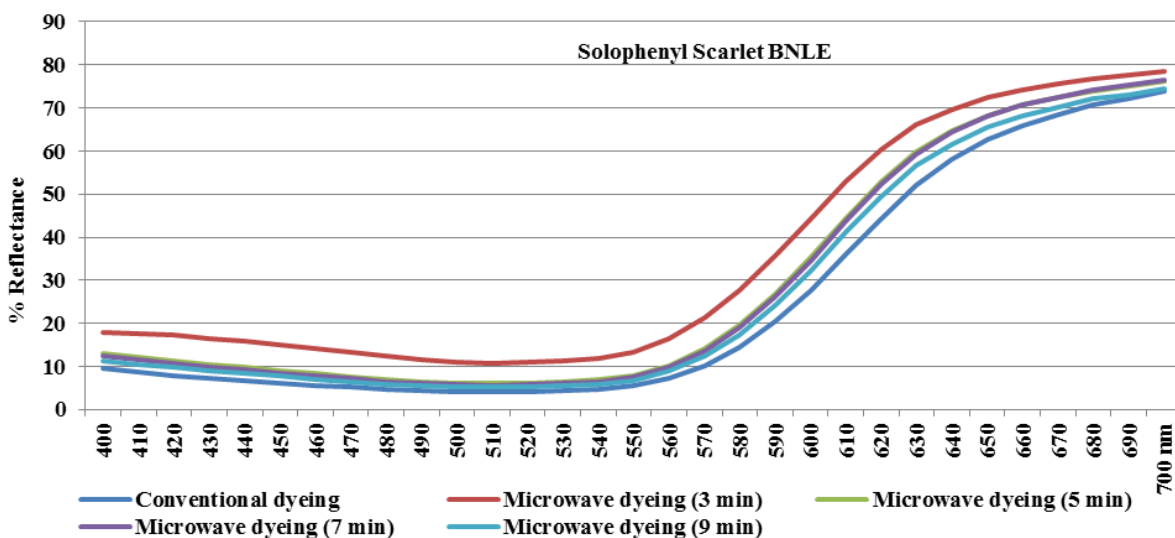

Figure 4 Reflectance (%) - Wavelength (nm) spectra of soybean fabrics dyed with Solophenyl Scarlet BNLE

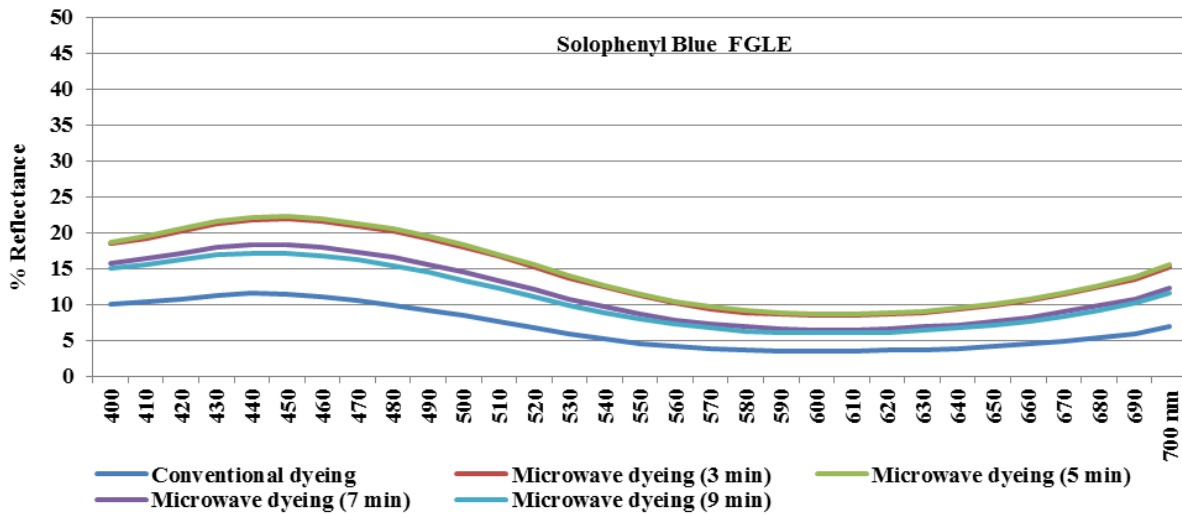

Figure 5 Reflectance (%)-Wavelength (nm) spectra of soybean fabrics dyed with Solophenyl Blue FGLE

It can be seen that the color yield values of soybean fabrics dyed with "Solophenyl Scarlet BNLE" using microwave energy increase as the microwave dyeing time increases (Figure 6 and Table 1). The highest color yield with microwave energy (8.561 K/S) was obtained in 9 minutes dyeing process. This color yield value was 23% lower than the color yield value obtained by the conventional method. Therefore, the  $L^*$  values of the samples dyed using microwave energy are higher than the  $L^*$  value of the sample dyed using the conventional method.

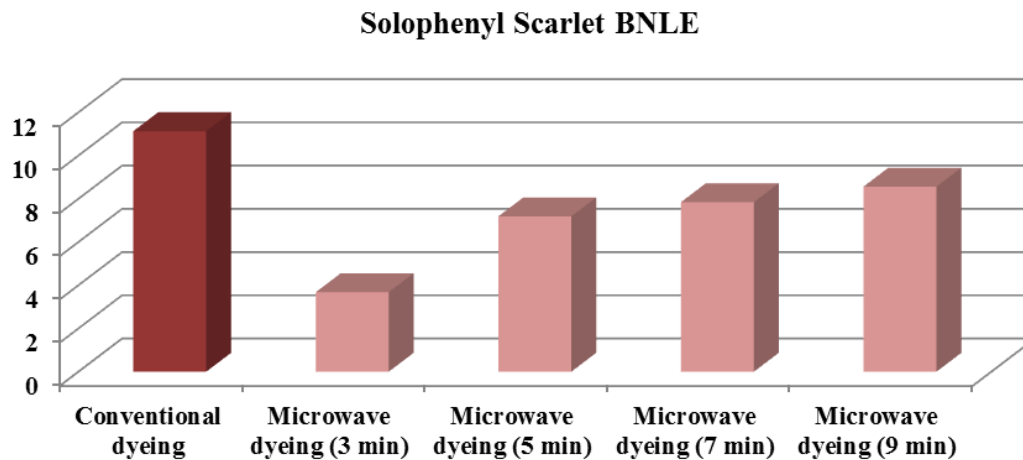

Figure 6 Color strength (K/S) values of dyed soybean fabrics with Solophenyl Scarlet BNLE



**Solophenyl Blue FGLE**

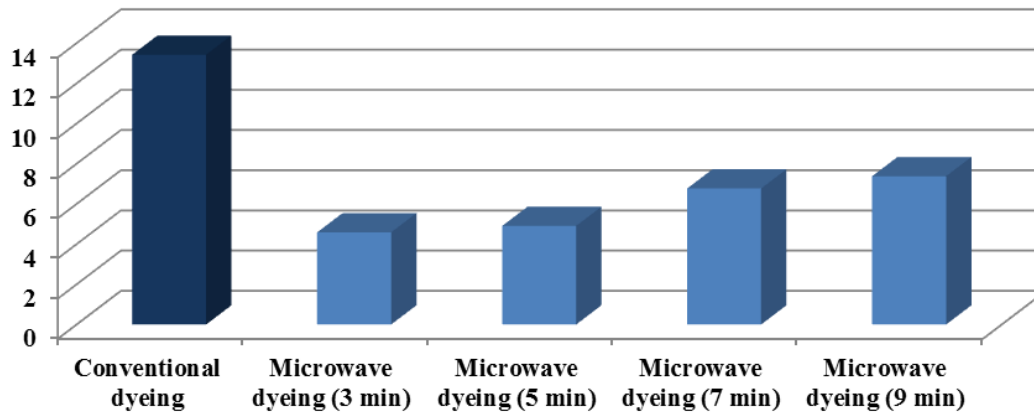

Figure 7 Color strength (K/S) values of soybean fabrics dyed with Solophenyl Blue FGLE





Measured and calculated color properties of direct dyed soybean fabric samples were presented in Table 1 and Table 2. The  $a^*$  (red-green axis),  $b^*$  (blue-yellow axis),  $C^*$  (Chroma) and  $h^0$  values of microwave dyed fabric samples increase along with the increase of dyeing duration. With the increase in the dyeing time, the  $a^*$  and  $b^*$  values of the samples approach to those of conventionally dyed samples. In other words, microwave dyed samples became redder and yellower depending on the dyeing time increase.

Table 1 Colorimetric properties of dyed soybean fabrics with Solophenyl Scarlet BNLE

Solophenyl Scarlet BNLE	K/S	$L^*$	$a^*$	$b^*$	$C^*$	$h^0$
Conventional dyeing	11,172	43,11	46,91	22,86	52,19	25,98
Microwave dyeing (3 min)	3,677	55,25	41,77	17,15	45,15	22,32
Microwave dyeing (5 min)	7,185	48,24	46,51	21,09	51,07	24,4
Microwave dyeing (7 min)	7,843	47,62	47,06	22,07	51,97	25,13
Microwave dyeing (9 min)	8,561	46,09	46,92	22,08	51,86	25,19

The color-yield values of soybean fabrics microwave dyed with Solophenyl Blue FGLE also increased in relation to the dyeing time increase which is similar to the color yields of Solophenyl Scarlet BNLE dyed samples (Table 2). The highest color yield was measured in the 9 minutes dyeing time in the microwave assisted direct dyeing. However, the highest color yield values of microwave dyeing were still below the color yield values of conventionally dyed soybean fabric samples. Microwave dyed soybean fabric samples exhibit lower lightness values ( $L^*$ ) compared to conventional dyeing.

*Table 2 Colorimetric properties of soybean fabrics dyed with Solophenyl Blue FGLE*

Solophenyl Blue FGLE		K/S	L*	a*	b*	C*	h <sup>o</sup>
Conventional dyeing		13,42	27,94	-1,53	-19,6	19,71	265,5
Microwave dyeing (3 min)		4,583	42,26	-4,67	-19	19,58	256,2
Microwave dyeing (5 min)		4,902	41,75	-4,49	-19,2	19,73	256,8
Microwave dyeing (7 min)		6,765	37,48	-3,6	-19,7	20,06	259,7
Microwave dyeing (9 min)		7,378	36,18	-3,01	-19,4	19,66	261,2

### Washing fastness and Rub fastness results

It can be observed that there was a little difference between the fastness values of soybean fabrics dyed with conventional and microwave energy method for both direct dyestuffs (Table 3). It can be seen from Table 3, microwave energy assisted dyed samples exhibited slightly better washing fastness results than conventional dyed samples. The lower color yield of microwave dyed fabrics is thought to cause this small difference. Moreover, rub fastness values of samples were also given in Table 3. The dry rub fastness values are 1 point higher for the samples dyed with microwave energy assistance. The lower color yield of microwave dyed fabrics could be the reason for this small rub fastness difference between both dyeing methods.

*Table 3 Wash and rub fastness properties of dyed soybean fabrics.*

		Wash Fastness Staining (C06-A2S)						Rub Fastness	
		Diacetate	Cotton	Polyamide	Polyester	Acrylic	Wool	Wet	Dry
Soybean fabrics dyed with Solophenyl Blue FGLE	Conventional dyeing	5	3	4-5	5	4-5	5	3-4	4
	Microwave dyeing (9 min)	5	3-4	4-5	5	4-5	5	3-4	5
Soybean fabrics dyed with Solophenyl Scarlet BNLE	Conventional dyeing	5	3	4-5	4-5	4-5	5	3-4	4
	Microwave dyeing (9 min)	5	3-4	4-5	5	4-5	5	3-4	5

### CONCLUSION

The applicability of microwave technology covers a wide area in the textile industry such as heating, drying, condensation process, dyeing and printing, finishing processes, surface modifications of textile materials. The use of microwave technology in the wet processing of textile industry provides time and energy savings. Dyeing liquor reaches boiling temperature in shorter periods during microwave energy assisted dyeing. Therefore, dyeing process can be applied in shorter operation times. In this study, dyeability of soybean fibers with direct dyes was investigated with microwave energy assistance. Conventional direct dyeing of the soybean fabrics was performed for 2 hours duration while the longest microwave energy assisted dyeing duration was 9 minutes. Although darker shaded colors were obtained in conventional dyeing process, the difference in the dyeing operation time has a great importance and advantage for the utilization of this technology in textile dyehouses.

## REFERENCES

- Büyükakıncı, B. Y. (2012). Usage of microwave energy in Turkish textile production sector. *Energy Procedia*, 14, 424-431.
- Özerdem, A., Tarakçıoğlu, I., & Özgüney, A. Mikrodalga enerjisinin Reaktif Baskılı Pamuklu Kumaşların Fiksajında Kullanılabilirliği. *Tekstil ve Konfeksiyon*, 18, 289-296.
- Yavaş, A., Kalaycı, E., Avinc, O. O., & Aras, G. (2017). Microwave Energy Fixation for Discharge on Cotton Fabric. In *International Conference on Engineering Technology and Innovation (ICETI)*. Sarajevo.
- Montazer, M., & Alibakhshi, F. (2007). Microwave assisted dyeing of cellulose with direct dyes. In *9th Asian Textile Conference* (pp. 28-30). Taiwan.
- Kalayci, E., Avinc, O., Yavas, A., & Coskun, S. (2019). Responsible Textile Design and Manufacturing: Environmentally Conscious Material Selection. In A. Y. Alqahtani, E. Kongar, K. K. Pochampally & S. M. Gupta (Eds.), *Responsible Manufacturing: Issues Pertaining to Sustainability*: Taylor & Francis.
- Salema, A. A., & Ani, F. N. (2012). Pyrolysis of oil palm biomass using palm shell char as microwave absorber. *Journal of Oil Palm Research*, 24, 1497-1510.
- Yıldırım, F. F., Avinc, O. O., & Yavas, A. (2015). Soybean protein fibres Part 2: Soybean fibres properties and application areas. *Uludağ University Journal of The Faculty of Engineering*, 20, 1-21.
- Avinc, O., & Yavas, A. (2017). Soybean: For Textile Applications and Its Printing. In *Soybean-The Basis of Yield, Biomass and Productivity*: InTech.
- Kalayci, E., Yavas, A., Avinc, O., & Bektas, M. (2018). Dyeability of Soybean Fibers with Acid Dyes Under Microwave Conditions. In *II. International Scientific and Vocational Studies Congress*. Nevşehir/Turkey.
- Choi, J. h., Kang, M. j., & Yoon, C. (2005). Dyeing properties of soya fibre with reactive and acid dyes. *Coloration Technology*, 121, 81-85.
- Choi, H., Shin, Y.-S., Choi, C.-N., Kim, S.-Y., & Chung, Y.-S. (2007). Dyeing properties and antimicrobial activity of soybean fiber with gromwell colorants. *Fashion & Textile Research Journal*, 9, 119-123.
- Noh, Y.-J., & Lee, S.-H. (2014). Natural dyeing of soybean protein fabrics-Gallnut. *Fashion & Textile Research Journal*, 16, 462-468.
- Clark, M. (2011). *Handbook of textile and industrial dyeing: principles, processes and types of dyes*: Elsevier.
- Aspland, J. (1991). Direct dyes and their application. *Textile Chemist and Colorist*, 23, 41-45.

## COLOR STRENGTH ESTIMATION OF RAFFIA FIBERS AFTER DIFFERENT ALKALI TREATMENTS

Can B. Kalayci\*

Department of Industrial Engineering, Pamukkale University, 20160, Denizli, Turkey  
[cbkalayci@pau.edu.tr](mailto:cbkalayci@pau.edu.tr)

Ece Kalayci, Ozan Avinc, Arzu Yavas

Department of Textile Engineering, Pamukkale University, 20160, Denizli, Turkey  
[ekalayci@pau.edu.tr](mailto:ekalayci@pau.edu.tr), [oavinc@pau.edu.tr](mailto:oavinc@pau.edu.tr), [aozerdem@pau.edu.tr](mailto:aozerdem@pau.edu.tr)

\*Corresponding Author: [cbkalayci@pau.edu.tr](mailto:cbkalayci@pau.edu.tr)

### ABSTRACT

*Raffia fiber, a trending lignocellulosic fiber peeled from palm tree leaves, has a potential to be used as a reinforcement fiber for composite structures as well as its use in home decoration, summer clothes and accessories. Raffia fiber is often applied to various treatment processes during its use. Alkalinity level and temperature of these treatments may lead to significant color differences on the fibers. In this study, the effects of different alkali treatments with various temperatures on the color strength of raffia fibers are firstly examined. Then, in order to obtain the estimation of color strength values on the samples of raffia fibers bleached with peracetic acid, various mathematical function models are utilized, and an artificial bee colony algorithm is used to optimize the weights of the functions. Sample data of the raffia fiber is used to verify the correctness of the color strength estimation model. The estimated results are compared with the results of experimental studies. Results show that the prediction model can fit the experimental results. The model based on artificial bee colony is a successful candidate to estimate the color strength of fibers.*

**Keywords:** Raffia fibers, alkali treatment, color strength estimation, swarm intelligence, artificial bee colony

### INTRODUCTION

Nature offers humanity a myriad of natural fiber sources, and humanity has benefited from these generous sources of fiber for centuries. However, by the introduction of oil based synthetic fibers into textiles, many of these natural fiber types have lost their importance. Although cotton has managed to preserve its existence for centuries as the most widely consumed natural fiber species, synthetic fibers have dominated the textile industry's fiber needs for many years. In recent years, the increase in the importance given to sustainable production, has provided to be evaluated forgotten natural fiber sources as a textile fiber again. Natural fibers have the characteristics that can meet the expectations of sustainable production with their biodegradable, renewable and non-hazardous properties (Chukwudi, Uzoma, Azuka, & Sunday, 2015; Fadele, 2017). Especially, fiber resources such as pineapple, banana, abaca and raffia fibers have become primary research field since their cultivation for industrial purposes (Kalayci, Avinc, Bozkurt, & Yavas, 2016; Tagne Nicodème Rodrigue, et al., 2017).

Raffia fiber is a lignocellulosic fiber which is peeled from leaves of raffia palm trees mostly found in the tropical and subtropical areas (Abu, Yalley, & Adogla, 2016; Fadele, 2017). The most trending usages of raffia fibers are summer clothes, shoes, handbags, carpets, blankets and home decorations (Figure 1) (Adams & Holdcraft, 1992; R. Elenga, Dirras, Maniongui, Djemia, & Biget, 2009; Fadele, 2017).

Recent reports have stated that raffia fibers can be used as reinforcement material in the polymer composite structures (Chukwudi, et al., 2015; R. G. Elenga, et al., 2013; Tagne Nicodème Rodrigue, et al., 2017). Raffia fibers are can be exposed to different pre or post treatment processes (such as alkali treatment) while their usage in composite structures (R. G. Elenga, et al., 2013; Fadele, 2017). Different alkali treatments and temperatures changes the color properties of lignocellulosic raffia fibers (E. Kalayci, Yavas, & Avinc, 2018).

Color properties of alkali treated raffia fabrics vary under different conditions. In this study, the color strength values (K/S) of raffia fiber fabrics alkali treated at various temperatures is estimated using an artificial bee colony algorithm, a swarm intelligence methodology.



**Figure 1.** Raffia palm tree, greige and dyed raffia fibers and fabrics  
 (photo source: <https://hatsbyrosieboylan.com/blogs/news/raffia-understanding-fibres>)

## MATERIALS AND EXPERIMENTS

In this study, plain woven raffia fabric (100% raffia fiber) which was supplied from Philippines was used for alkali treatments study. Alkali treatment was performed at various temperatures by using sodium hydroxide and sodium carbonate in order to determine the effects of alkalinity and temperature on the color properties of raffia fibers. Alkali treatment and control treatment conditions are given in the Table 1. Color strength values of the raffia fabric samples were determined using a DataColor 600 spectrophotometer. Each fabric sample was measured from four different areas, and the average values were calculated.

**Table 1.** Treatments conditions of raffia fibers (E. Kalayci, et al., 2018)

pH	Alkali treatment	Time	Temperature (°C)
7.5	Control* (1g/l wetting agent)	30 min.	40, 50, 60, 70, 80, 90, 100
10.5	1g/l wetting agent 2% owf Na <sub>2</sub> CO <sub>3</sub>	30 min.	40, 50, 60, 70, 80, 90, 100
12.5	1g/l wetting agent 2% owf NaOH	30 min.	40, 50, 60, 70, 80, 90, 100
13.5	1g/l wetting agent 5% owf NaOH	30 min.	40, 50, 60, 70, 80, 90, 100

\*Control process was performed with the absence of alkali agent due to the determination of the effects of temperature on the color properties of raffia fibers

The color strength (K/S) values of alkali treated raffia fabrics are shown in Table 2. In general, as the pH level and alkali treatment temperature increases, the K/S (color strength) degrees of the alkali treated raffia fabrics gradually increases. Moreover, the color of the raffia fabrics becomes darker and yellower in line with the visual observation.

**Table 2.** Color properties of raffia woven fabrics after control treatments varying different temperatures (K/S value of untreated raffia fabric is 4.90) (E. Kalayci, et al., 2018)

pH	Temperature (°C)	K/S	pH	Temperature (°C)	K/S
7.5	40	5.19	12.5	40	8.60
7.5	50	6.49	12.5	50	9.60
7.5	60	6.47	12.5	60	14.0
7.5	70	6.72	12.5	70	14.4
7.5	80	8.31	12.5	80	14.7
7.5	90	8.23	12.5	90	19.7
7.5	100	8.30	12.5	100	21.3
10.5	40	7.61	13.5	40	12.9
10.5	50	7.58	13.5	50	15.0
10.5	60	8.17	13.5	60	16.1
10.5	70	8.47	13.5	70	15.0
10.5	80	11.4	13.5	80	17.8
10.5	90	12.3	13.5	90	21.5
10.5	100	12.4	13.5	100	23.0

## ESTIMATION METHODOLOGY AND RESULTS

Based on the concept employed in the works on artificial intelligence, inspired by nature, especially biological systems, swarm intelligence systems consist of a population of simple agents that locally interact with one another in their environment. Swarm intelligence systems that follow very simple rules include examples such as fish schooling, bee and ant colonies, bird flocking and bacterial growth. Based on collective flock intelligence of swarms, Karaboga (2005) firstly proposed the artificial bee colony algorithm inspiring of the social behavior of honey bees looking for food sources. The bee colony consists of three kinds of bees: employed bees, onlooker bee and scout bees. In this study, artificial bee colony algorithm (Can B. Kalayci, Ertenlice, Akyer, & Aygoren, 2017; C. B. Kalayci & Gupta, 2013; C. B. Kalayci, Hancilar, Gungor, & Gupta, 2015) is utilized for color strength estimation of raffia fibers after different alkali treatments.

Firstly, a random bee population for the available food locations is randomly initialized using Equation (1) where  $i$  represents a bee in the population,  $j$  represents the problem dimension and  $x_j^{max}$  and  $x_j^{min}$  represents the upper and lower limits of the problem search space, respectively.

$$x_{ij} = x_j^{min} + rand(0,1)(x_j^{max} - x_j^{min}) \quad (1)$$

Then, employed bees investigate the food sources in which the amount of nectar is high using Equation (2). Onlooker bees follow the nectar information shared by the employed bees to further exploit the food sources with high content using the same equation where  $v_i$  represents a new solution in the neighborhood of the current solution,  $x_i$  represents the current solution,  $x_k$  represents a random neighbor of the current solution,  $\phi_{ij}$  represents a random value selected in the range  $[-1,1]$  and  $D$  represents the problem dimension. If a newly obtained solution is better than the previous solution, the new information about is saved, otherwise discarded

$$v_{ij} = x_{ij} + \phi_{ij}(x_{ij} - x_{kj}), j = 1, \dots, D \quad (2)$$

Lastly, scout bees are responsible for randomly discovering new food locations using Equation (1) once the nectar amount is fully consumed, meaning that the current solution cannot be further improved. All these steps form one cycle of the algorithm and continue until the stopping criteria are met.

The mathematical functions used in the model are given in Equations (3-8). The algorithm aims to minimize the total error and reveal the most accurate estimation values. Here, six different functions; linear (Equation 3), quadratic (Equation 4), cubic (Equation 5), exponential (Equation 6), sigmoid (Equation 7) and exponential-trigonometric (Equation 8) are utilized for parameter optimization to estimate the color strength of raffia fibers after different alkali treatments.

$$F_{linear} = w_1 + w_2X_1 + w_3X_2 \quad (3)$$

$$F_{quadratic} = w_1 + w_2X_1 + w_3X_2 + w_4X_1X_2 + w_5X_1^2 + w_6X_2^2 \quad (4)$$

$$F_{cubic} = w_1 + w_2X_1 + w_3X_2 + w_4X_1X_2 + w_5X_1^2 + w_6X_2^2 + w_7X_1^2X_2 + w_8X_2^2X_1 + w_9X_1^3 + w_{10}X_2^3 \quad (5)$$

$$F_{exponential} = w_1 + w_2X_1^{w_3} + w_4X_2^{w_5} \quad (6)$$

$$F_{sigmoid} = w_1 + w_2/(1 + e^{w_3X_1}) + w_4/(1 + e^{w_5X_2}) \quad (7)$$

$$F_{exponential-trigonometric} = w_1 + w_2e^{w_3X_1+w_4X_2+w_5} \tanh(w_6X_1 + w_7X_2 + w_8) \quad (8)$$

$x_1$ : time in minutes,  $x_2$ : peracetic acid asit (g/l)

Figure 2 presents the estimation results of various functions corresponding to the original experiments while detailed results are presented in Table 3. The exponential-trigonometric form has achieved the best results while the cubic form has been the runner-up.

As a result, in the worst case, average percentage gap was 16.77% between the estimation results and the original experiment results.

*Table 3. Estimation of color strength and error percentages of various functions*

Experiment	Linear Form	Quadratic Form	Cubic Form	Exponential Form	Sigmoid Form	Exponential-Trigonometric Form
5.19	2.76	6.20	5.49	4.63	2.76	6.20
7.61	8.20	7.45	6.64	7.16	8.20	7.45
8.63	11.82	11.67	12.28	12.19	11.82	10.55
19.90	13.63	14.80	16.86	15.80	13.62	19.66
6.49	3.87	5.88	5.93	4.86	3.88	6.46
7.58	9.31	7.56	6.71	7.39	9.32	7.97
9.62	12.93	12.07	11.54	12.42	12.93	10.82
15.00	14.74	15.34	15.55	16.03	14.73	15.43
6.47	4.99	5.94	6.71	5.47	4.99	6.79
8.17	10.42	8.05	7.63	8.01	10.43	8.68
13.99	14.04	12.84	11.99	13.04	14.05	11.62
16.10	15.85	16.25	15.59	16.65	15.85	15.19
6.72	6.10	6.37	7.55	6.44	6.11	7.16
8.47	11.53	8.90	9.13	8.98	11.55	9.61
14.37	15.15	13.97	13.36	14.01	15.16	12.90
15.00	16.97	17.53	16.73	17.62	16.96	16.22
8.31	7.21	7.17	8.17	7.75	7.22	7.56
11.42	12.64	10.13	10.91	10.28	12.66	10.81
14.70	16.27	15.49	15.36	15.31	16.27	14.69
17.80	18.08	19.18	18.66	18.92	18.07	18.14
8.23	8.32	8.34	8.28	9.37	8.32	7.90
12.28	13.76	11.73	12.70	11.91	13.76	12.33
19.69	17.38	17.37	17.70	16.94	17.38	17.10
21.50	19.19	21.21	21.11	20.55	19.17	20.95
8.30	9.43	9.89	7.59	11.32	9.42	8.05
12.39	14.87	13.70	14.20	13.85	14.86	14.20
21.32	18.49	19.63	20.10	18.88	18.48	20.28
23.00	20.30	23.61	23.79	22.49	20.27	24.81
Average Gap (%)	16.75	9.50	8.93	11.58	16.77	7.32

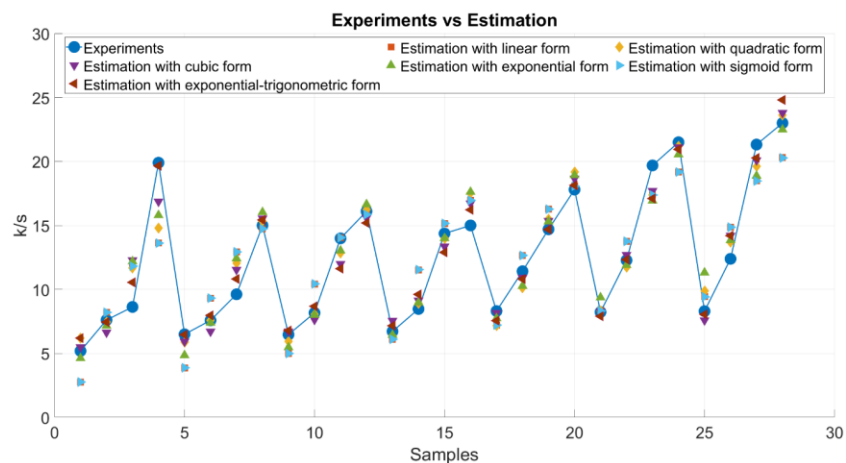

**Figure 2.** Estimation results of various functions corresponding to the original experiments



## CONCLUSION

In this study, firstly the effects of different alkali treatments with various application temperatures on the colorimetric properties of raffia fibers were explored. The higher treatment temperature led to higher color strength values with darker shades. The alkalinity level of wet-processing treatments and the temperature increase may lead to significant color differences on the raffia fibers. Secondly, it was aimed to estimate the color strength of raffia fibers after different alkali treatments by means of an artificial bee colony algorithm utilizing various mathematical functions. The model achieved a successful fit on the samples. The results confirmed that the artificial bee colony algorithm could achieve high estimation accuracy to estimate the color strength of the fiber.

## ACKNOWLEDGEMENTS

This study was supported by Scientific Research Coordination Unit of Pamukkale University.

## REFERENCES

- Abu, A. K., Yalley, P. P. K., & Adogla, F. (2016). The Use of Raffia Palm (Raffia Hookeri) Piassava Fibres As Reinforcement Of Concrete. *The International Journal of Engineering and Science*, 5, 01-06.
- Adams, M., & Holdcraft, T. R. (1992). Dida Woven Raffia Cloth from Côte d'Ivoire. *African Arts*, 25, 42-51.
- Chukwudi, A. D., Uzoma, O. T., Azuka, U.-A. A., & Sunday, E. C. (2015). Comparison of Acetylation and Alkali Treatments on the Physical and Morphological Properties of Raffia Palm Fibre Reinforced Composite. *Science*, 3, 72-77.
- Elenga, R., Dirras, G., Maniongui, J. G., Djemia, P., & Biget, M. (2009). On the microstructure and physical properties of untreated raffia textilis fiber. *Composites Part A: Applied Science and Manufacturing*, 40, 418-422.
- Elenga, R. G., Djemia, P., Tingaud, D., Chauveau, T., Maniongui, J. G., & Dirras, G. F. (2013). Effects of alkali treatment on the microstructure, composition, and properties of the Raffia textilis fiber. *BioResources*, 8, 2934-2949.
- Fadele, O. E. (2017). *Development and Characterization of Raffia Palm Fiber Reinforced Polymer Matrix Composites*. University of Saskatchewan, Saskatoon.
- Kalayci, C. B., Ertenlice, O., Akyer, H., & Aygoren, H. (2017). An artificial bee colony algorithm with feasibility enforcement and infeasibility toleration procedures for cardinality constrained portfolio optimization. *Expert Systems with Applications*, 85, 61-75.
- Kalayci, C. B., & Gupta, S. M. (2013). Artificial bee colony algorithm for solving sequence-dependent disassembly line balancing problem. *Expert Systems with Applications*, 40, 7231-7241.
- Kalayci, C. B., Hancilar, A., Gungor, A., & Gupta, S. M. (2015). Multi-objective fuzzy disassembly line balancing using a hybrid discrete artificial bee colony algorithm. *Journal of Manufacturing Systems*, 37, 672-682.
- Kalayci, E., Avinç, O. O., Bozkurt, A., & Yavaş, A. (2016). Tarımsal atıklardan elde edilen sürdürülebilir tekstil lifleri: Ananas yaprağı lifleri. *Sakarya Üniversitesi Fen Bilimleri Enstitüsü Dergisi*, 20, 203-221.
- Kalayci, E., Yavas, A., & Avinc, O. (2018). The Effects of Different Alkali Treatments with Different Temperatures on the Colorimetric Properties of Lignocellulosic Raffia Fibers. In *International conference on Recent Advances in Engineering and Technology*. Havana, Cuba.
- Karaboga. (2005). An idea based on honey bee swarm for numerical optimization. In: Technical report-tr06, Erciyes university, engineering faculty, computer engineering department.

- Tagne Nicodème Rodrigue, S., Ebénézer, N., Dieunedort, N., Didier, F., Fogue, M., Drean, J.-Y., & Harzallah, O. (2017). Investigation of the Physical and Mechanical Properties of Raffia Vinifera Fibers along the Stem. *Journal of Natural Fibers*, 14, 621-633.
- Chukwudi, A. D., Uzoma, O. T., Azuka, U.-A. A., & Sunday, E. C. (2015). Comparison of Acetylation and Alkali Treatments on the Physical and Morphological Properties of Raffia Palm Fibre Reinforced Composite. *Science*, 3, 72-77.
- Fadele, O. E. (2017). *Development and Characterization of Raffia Palm Fiber Reinforced Polymer Matrix Composites*. University of Saskatchewan, Saskatoon.
- Kalayci, C. B., Ertenlice, O., Akyer, H., & Aygoren, H. (2017). An artificial bee colony algorithm with feasibility enforcement and infeasibility toleration procedures for cardinality constrained portfolio optimization. *Expert Systems with Applications*, 85, 61-75.
- Kalayci, C. B., & Gupta, S. M. (2013). Artificial bee colony algorithm for solving sequence-dependent disassembly line balancing problem. *Expert Systems with Applications*, 40, 7231-7241.
- Kalayci, C. B., Hancilar, A., Gungor, A., & Gupta, S. M. (2015). Multi-objective fuzzy disassembly line balancing using a hybrid discrete artificial bee colony algorithm. *Journal of Manufacturing Systems*, 37, 672-682.
- Karaboga. (2005). An idea based on honey bee swarm for numerical optimization. In: Technical report-tr06, Erciyes university, engineering faculty, computer engineering department.
- Kalayci, C. B., Ertenlice, O., Akyer, H., & Aygoren, H. (2017). An artificial bee colony algorithm with feasibility enforcement and infeasibility toleration procedures for cardinality constrained portfolio optimization. *Expert Systems with Applications*, 85, 61-75.
- Kalayci, C. B., & Gupta, S. M. (2013). Artificial bee colony algorithm for solving sequence-dependent disassembly line balancing problem. *Expert Systems with Applications*, 40, 7231-7241.
- Kalayci, C. B., Hancilar, A., Gungor, A., & Gupta, S. M. (2015). Multi-objective fuzzy disassembly line balancing using a hybrid discrete artificial bee colony algorithm. *Journal of Manufacturing Systems*, 37, 672-682.
- Karaboga. (2005). An idea based on honey bee swarm for numerical optimization. In: Technical report-tr06, Erciyes university, engineering faculty, computer engineering department.

## USAGE OF DIGITAL AND 3D PRINTING TECHNOLOGIES IN DENIM JEANS DESIGN AS AN ECOLOGICAL SOLUTION

Ece Kalaycı, Arzu Yavas\* and Ozan Avinc

Pamukkale University, Faculty of Engineering, Textile Engineering Department, Denizli/TURKEY 20160  
e-mail [aozerdem@pau.edu.tr]

### ABSTRACT

*Manufacturers continuously begin a quest of sustainable materials, methods and technology to meet the consumer's demand for more environmentally friendly products as a result of enhanced environmental conscious. Denim jeans, having a wide range of usage, are one of the product groups with high environmental impact within the textile industry. Research studies about the usage of sustainable methods and technologies in the denim industry are of great importance for the future of the sector. In general, technologies aiming reduced water, energy and chemical consumptions are becoming widespread in denim industry day by day. Laser and ozone technologies are particular examples of these sustainable technologies. The use of digital printing and 3D printing technologies in textiles is quite new and limited. However, the ecological advantages of these technologies are promising future for both denim and textile industry. Herewith, the usage of environmentally friendly digital and 3D printing technologies in denim manufacturing detailly examined in this review.*

**Key words:** Denim, jeans, digital printing, 3D printing, sustainability, responsible manufacturing, environmental friendly

### INTRODUCTION

Textile products are in a state of flux as a result of fashion and fast consumption habits. An outfit that much loved and worn out today can be forgotten at the bottom of the closet tomorrow. However, denim products challenge the years with widespread use by people from all genders, ages and classes (Nagori, 2018). Due to its durable and robust construction, the denim fabric, first used in workers' clothing, managed to enter the consumer's wardrobe not only as a pants, but also as a jacket, shirt, skirt and even bag.

It is thought that the name of “denim” comes from a town of Nimes (de Nimes) in France (Paul, 2015; Townsend, 2011). It is estimated that the word “jean” was started to be used in the nineteenth century after Genovese (the French name of Genoa is “Gene”) sailors began to use special woven cotton fabric, which was colored with indigo blue (Foreman, 2015). Although the exact origins of the denim fabric are not clearly known, the first manufacturer of the denim jeans in other words denim trousers is Levi Strauss. Levi and a tailor named "Jacob Davis" got a patent to produce trousers using rivet to strengthen the pockets of the trousers in 1873. After patenting this product, they began to produce jeans, which are a durable and comfortable product, especially for workers.

Denim jeans could be acceptable as the most extensively used garment in the fashion and textile industries. Although, at the beginning, denim jeans were accepted as the symbol of hard workers, rebellion spirit of youth and American cowboys, today denim jeans only symbolize comfort and casual apparel.

Even though denim jeans exhibit a social culture which embraces people from every economic classed, there is also a niche denim market which is evolved by consumers preferences and luxury brand desire (Nagori, 2018) (Figure 1).

Traditionally produced denim fabric is made from 100% cotton. Lately elastic fibers which bring easy use and comfort to the fashionare (ease of use) started to be used in denim fabrics. Nowadays, not only elastic fibers but also synthetic or natural blended cotton fibers can be used for denim fabric production for jeans. Moreover, today most of the consumers prefer the old look jeans instead of indigo blue jeans. For this reason, bleaching and fading processes are generally applied on the indigo dyed denim jeans in order to impart old-used and worn-out appearance. Unfortunately, the most of these bleaching and fading processes are dangerous for environment and human health. In the recent years, where a sustainable future is targeted in all areas of the industry, the textile industry, which comprises highly water and chemical processes, has a great increasing responsibility. Denim jeans manufacturing step forward with its water and chemical consumption among the textile wet processes. Therefore, sustainable production methods and technologies in denim production have become an important research topics for researchers and scientists. In the literature, many methods and technologies were proposed aiming to offer a sustainable denim production. In our review, we were focused on the usage of digital printing and 3D printing technologies which are recently prominent. The state of these technologies in denim production were extensively examined in our review under the topics such as usage, advantages, disadvantages and future of these technologies.



*Figure 1: Timeless denim jeans (Wikimedia\_Commons, 1952, 2012)*

## **DENIM DESIGN AND MANUFACTURING**

Denim fabric can be generally identified as a durable and stiff warp faced twill cotton fabric (mostly 3/1), woven with indigo dyed warp and undyed weft yarns (Paul, 2015). Denim fabric is used for jean production, also bleaching and fading processes are applied to the denim jeans as a garment according to create a desired design (Figure 2).

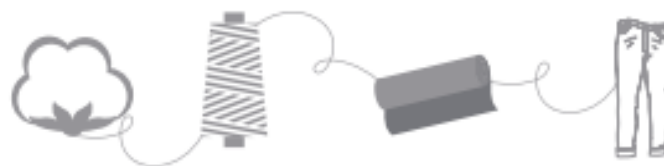

*Figure 2: Traditional denim jeans manufacturing steps (TAYPA, 2017)*

### **Cotton Fiber to Yarn**

Cotton fiber is the most widely used fiber in the denim production even if it can be blended with natural (linen, hemp, wool, kapok, etc.) (Turkoglu, Kalayci, Avinc, & Yavas, 2019), regenerated (modal, bamboo, lyocell, etc.) and synthetic fibers (PET, Lycra<sup>®</sup>, PTT, PBT, Dyneema<sup>®</sup>, PBO etc.) (Ece Kalayci, Avinc, & Yavas, 2016; Yildirim, Avinc, & Yavas, 2012; Ece Kalayci, Avinc, & Yavas, 2015). The cotton yarn to be used in denim production is mostly produced in conventional spinning systems. Warp yarn quality is more important than weft yarn for denim fabrics since it is only warp dyed fabric. It is reported that rotor spinning is more preferred method than the conventional ring spinning for warp yarn spinning (Paul, 2015).

### **Indigo Dye and Dyeing Process**

Indigo is a natural dye which gives the blue color to the fabric and it is extensively used for denim coloration. When the capacity of denim industry is considered, it is nearly impossible to satisfy its natural indigo demand. Thus, the use of natural indigo has been prevailed by synthetic indigo. Only warp yarns are dyed with indigo in the denim production as mentioned before so this process has a critical importance for denim quality. There are two options for indigo warp dyeing as rope dyeing and slasher dyeing. Particular attention should be paid to the parameters such as the amount of reducing agent, temperature and pH during the indigo dyeing. Indigo dyeing is carried out with very high water and chemical (reducing agent and dyestuff) consumption. Loop dyeing machine developed to reduce the water and chemical consumption has pretreatment boxes and a single bath with one squeezing unit (Paul, 2015; Muthu, 2017).

### **Dyeing with non-indigo dyes**

Sulfur dyes are another choice for denim coloration instead of indigo dyes due to their high affinity to cotton and high color efficiency. Sulfur dyes are especially used in denim warp dyeing for jean designs where dark and vibrant colors were desired.

### **Fabric to Garment**

Weaving is the last step of the denim fabric manufacturing. Denim fabric is woven with indigo dyed warp and undyed weft. Fabric features such as tensile strength, fabric weight per unit area, thickness, drape and cover are important for the final garment quality and specialties. Therefore, care must be taken for correct preference of the yarn count and the possible errors in weaving. Joining techniques and stitches are very important for denim jean design since they refer to jeans' style, fitting and shape.

### **Fading Methods and Washing Processes**

Traditional denim jeans have plain, blue color which is far from the fashion concerns. Washing and fading processes have the potential to give countless variety of appearance to the jeans. Stone washing is the most used washing. Enzyme washing is an alternative to the stone washing but it can be combined with stone washing for various effects and reducing environmental influences. Bleaching is another method for obtaining old look denim effects. Potassium permanganate, sodium chloride and sodium hypochlorite are the most preferred bleaching agent during denim jeans bleaching. There are also some physical fading processes such as sanding, brushing, embroidering, and sand spraying etc (Ozguney, Ozcelik, & Ozkaya, 2009). Laser, ozone, water jet and digital printing technologies are also started to be used in denim jean production as a sustainable and ecological alternative (Khalil, 2015).

## **INFLUENCES OF DENIM PRODUCTION ON THE ENVIRONMENT**

Denim jean production includes many processes threatening the environment from the cultivation of the cotton plant to the garment creation.

Alternative ecological recommendations to these processing steps for more sustainable future and production approach are one of the most popular research topics of the recent years. Recently, denim production methods and technologies which contribute to the sustainable future and sustainable manufacturing approach become important research topics in order to reduce damage of traditional denim wet processes. Hazardous effects of the denim production on the environment and alternative sustainable methods/technologies were summarized in Table 1. Cotton fiber is the main material of the denim jean, but hazardous effects are starting with the cotton cultivation. Cotton plant needs serious amount of irrigation, fertilizer and pesticides leading to crucial soil and water pollution. Organic cotton can be a solution to eliminate these dangerous effects. Hazardous effects continue during indigo warp dyeing with the usage of high water, reducing agent and synthetic indigo dye. In this step, environment faces with serious effluent water containing a significant amount of chemicals. This indirectly causes the pollution of agricultural products and obviously threatens human health. New generation indigo dyeing machines which consuming less water, less reducing agents and less indigo can be an eco-friendly alternative to the traditional ones. Unfortunately, hazardous effects of the denim jean production are not limited with these mentioned effects. Denim wet processes which contain various type of washings, bleaching and finishing applications are the most harmful step of the denim jean design and production. These processes exhibit the most intense water and chemical consumptions. Also these application steps threaten the environment, employee and human health. Novel green technologies such as laser, ozone and digital printing possess a great potential for today and future of the sustainable denim manufacturing.

*Table 1: Harmful effects of denim production to the environment and sustainable methods and technologies aiming to reduce these harmful effects (Muthu, 2017; Ozguney, et al., 2009; Khalil, 2015; Lucas, Belino, Miguel, Pereira, & Ribeiro, 2015)*

<b>Hazardous Effects of Denim Production to The Environment</b>	<b>Sustainable Methods and Technologies for Denim Production</b>
<ul style="list-style-type: none"> <li>• Water consumption</li> <li>• Energy consumption</li> <li>• Chemical consumption</li> <li>• Waste water problem</li> <li>• Water pollution</li> <li>• Soil and air pollution (indirect—as a result of water pollution)</li> <li>• Contaminated (polluted) agriculture</li> <li>• Employee health issues</li> </ul>	<ul style="list-style-type: none"> <li>• Organic cotton or better cotton usage</li> <li>• Alternative natural cellulosic fibers usage (hemp, linen, etc)</li> <li>• Usage of renewable energy sources (solar panels, etc.)</li> <li>• Reducing chemical use</li> <li>• Reducing indigo use</li> <li>• Enzyme usage during denim washing and fading</li> <li>• Purification of waste water</li> <li>• Decreasing indigo usage</li> <li>• Usage of new generation more ecologic machines (less chemical, less stone, less water)</li> <li>• Usage of laser technology</li> <li>• Usage of ozone technology</li> <li>• Usage of water jet technology</li> <li>• Usage of digital printing technology</li> <li>• Usage of 3D printing technology</li> <li>• Recycle of denim products</li> </ul>

## DIGITAL PRINTING TECHNOLOGIES IN DENIM JEAN PRODUCTION

Textile coloration processes both dyeing and printing are among the most water consuming steps in wet textile processes. After textile industry meet the digital printing machines, it has become possible to save water and energy compared with the traditional printing techniques (Ujiie, 2006). Many textile futurists and doyens predict that the majority of printed fabric production in the future will be produced with the usage of digital printing machines due to their easier use for personalized textile design. Denim production is among the textile product groups that can benefit from the ecologic advantages of digital printing technology. Reduced colorant amounts on the fabric surface with less water and energy consumption made this technology important for denim design and manufacturing. Digital printing in denim production exhibits many advantageous such as applicability of numerous various patterns and colors with ease on ready-to-wear garments and its easy adaptability for small boutique and niche production (Figure 3). Digitally printed denim jeans cause less environmental harmful effects than chemical or mechanical washing techniques (Paul, 2015; Lucas, et al., 2015).

Digital printed denim fabrics are thought to be an important environmentalist alternative for both manufacturers and consumers with the contribution of fast changing fashion and personalized fashion approaches.

Unlimited color and pattern options are one of the biggest advantages of digital printed denim fabrics (Lucas, et al., 2015). Moreover, digital printed denim products capture a great attention due to their personalized design applicability and fast production rates. Finally, the amount of dyestuff consumed in digital printing and the less water and energy consumption compared to the traditional methods offer an alternative solution for the environmentally sensitive customer group.



Figure 3: Digital printed denim jeans examples (Kornit\_Digital, 2019)

### 3D PRINTING TECHNOLOGIES IN DENIM JEAN PRODUCTION

Three-Dimensional (3D) printers are without a doubt one of the most popular inventions of the recent years. They have started to appear in every aspect of our lives with the spread of this technology. Nowadays, it is thought that 3D printers, which are used as a small-scale production alternative, will replace many production methods in the near future.

Textile industry also embraces the use of 3D printers for different areas. In the recent years, there have been many studies in this area in the form of creating a 3-D textile structure or adding a new surface with a three-dimensional printer on the existing textile surface (Yildiran, 2016; Partsch, Vassiliadis, & Papageorgas, 2015). Special importance is given to 3D printed textile products especially by sports product brands. 3D dimensional printers have succeeded in expanding the field of textile industry and entering the denim sector. There is one study, already been prototyped, which belongs to Levi's and a 3D printer Fast Company (*Fast\_Company, 2017*). In this study, aiming to reduce wet processes and having more sustainable manufacturing, a virtual mold was designed for every piece of a denim jacket. Denim jacket produced with 3D printer assistance and 3D printed collar mold were displayed in Figure 4. It can be seen from the photos that there is no real stitches, pockets and metals accessories on the fabric.

In this study, it was not intended to produce one-to-one copy of the denim jacket with the aid of 3D printer, on the contrary, all details of denim jacket were aimed to be obtained on a new jacket with the help of 3D printed molds.

The sustainable and responsible manufacturing approach has forced many textile companies to seek ecological technology and alternative methods in the recent years (Alqahtani, Kongar, Pochampally, & Gupta, 2019; E Kalayci, Avinc, Yavas, & Coskun, 2019). Therefore, the companies with high environmental impact should act more responsibly for their production styles. It has become one of the industrial targets to create a company profile that can respond to the demand of the consumers in a wide range of products, and in doing so; companies can fulfill their responsibilities towards the environment and the future. Therefore, it is estimated that new researches on the use of 3D printers in the denim industry will continue with increment.

Although consumers are accustomed to see the denim fabrics as ready to wear garments, denim fabrics can also be utilized in product groups such as bags, wallets or shoes etc. In another study, combining 3D printer and denim fabric, men's wallet was designed from denim fabric. A male wallet from denim fabric was designed with a 3D printer by creating flexible surfaces and structures on the denim fabric. As a result of this study, it was reported that it is possible to produce functional and technical textile products with the usage of denim and 3D printers apart from regular wallet or garments (Baldwin, 2018).



Figure 4: 3D printed denim example (*Fast\_Company, 2017*)



## CONCLUSION

The expansion of the idea of environmentally conscious manufacturing leads both producers and consumers to seek more ecological solutions. Although the use of 3D printers and digital printing in the denim industry is still very new, their ecological and economical advantageous increases their potential usage for future textile manufacturing. It should be kept in mind that it is obvious that social and environmental investments have a great advantage for brand identity. In addition, environment-friendly production has become a parameter demanded not only by the manufacturers but also by the consumers. Therefore, it is of great importance for the future of the textile industry to increase the brand value and to research ecological production methods and technologies in order to win the environmentally sensitive consumers. Consequently, the state of two novel technologies which exhibit high ecological advantages in denim industry was particularly reviewed in this paper. In conclusion, although today's usage of these two technologies is very new on denim fabrics, these two technologies are expected to play an important role in the responsible and sustainable manufacturing of the denim industry leading to more sustainable world.

## REFERENCES

- Nagori, N. A. (2018). Denim–The Timeless Fabric"- An Approach Towards Re-Use in Lower Garment. *International Journal of Current Research*, 10, 2018.
- Paul, R. (2015). Denim and jeans: an overview. In R. Paul (Ed.), *Denim Manufacture, Finishing and Applications* (pp. 1-11). Cambridge: Elsevier.
- Townsend, K. (2011). The denim garment as canvas: exploring the notion of wear as a fashion and textile narrative. *Textile*, 9, 90-107.
- Foreman, K. (2015). Jean genie: The denim evolution. In (Vol. 2019).
- Wikimedia\_Commons. (1952). Young woman modelling a pair of denim jeans and a checked shirt, 1952. In (Vol. 2019).
- Wikimedia\_Commons. (2012). Flared current elliott bell bottom jeans-60's 70's style. In (Vol. 2019).
- TAYPA. (2017). TAYPA Sürdürülebilirlik Raporu. In (Vol. 2019). İstanbul.
- Turkoglu, K. B., Kalayci, E., Avinc, O., & Yavas, A. (2019). Oleofilik Buoyans Özellikli Kapok Lifleri ve Yenilikçi Yaklaşımlar. *Düzce Üniversitesi Bilim ve Teknoloji Dergisi*, 7, 61-89.
- Kalayci, E., Avinc, O. O., & Yavas, A. (2016). Yüksek performanslı polietilen (HPPE) lifleri. *Marmara Fen Bilimleri Dergisi*, 1, 13-34.
- Yildirim, F. F., Avinc, O. O., & Yavas, A. (2012). Poli (trimetilen Tereftalat) Lifleri Bölüm 1: Üretimi, Özellikleri, Kullanım Alanları, Çevresel Etkisi. *Tekstil ve Mühendis*, 19.
- Kalayci, E., Avinc, O. O., & Yavas, A. (2015). Yüksek Performanslı PBO (poli-p-fenilenbenzobisoksazol) Lifleri. *Tekstil ve Mühendis*, 22.
- Muthu, S. S. (2017). *Sustainability in Denim*: Woodhead Publishing.
- Ozguney, A. T., Ozcelik, G., & Ozkaya, K. (2009). A Study on Specifying The effect of Laser Fading Process on The Colour and Mechanical Properties of the Denim Fabrics. *Journal of Textile & Apparel/Tekstil ve Konfeksiyon*, 19.
- Khalil, E. (2015). Sustainable and ecological finishing technology for denim jeans. *AASCIT Communication*, 2, 159-163.
- Lucas, J., Belino, N., Miguel, R., Pereira, M., & Ribeiro, L. (2015). Digital printing techniques for denim jeans. In R. Paul (Ed.), *Denim manufacture, finishing and applications* (pp. 287-312). Cambridge: Elsevier.
- Ujiie, H. (2006). *Digital printing of textiles*. Cambridge: Woodhead Publishing.
- Kornit\_Digital. (2019). Denim. In (Vol. 2019).
- Yıldıran, M. (2016). Moda giyim sektöründe üç boyutlu yazıcılarla tasarım ve üretim. *Art-e Sanat Dergisi*, 9, 155-172.

- Partsch, L., Vassiliadis, S., & Papageorgas, P. (2015). 3D printed textile fabrics structures. In *The International Istanbul Textile Congress, Istanbul, Turkey*. İstanbul.
- Fast\_Company. (2017). Your Jean Jacket Of The Future Could Be Made Using 3D Printing Tech. In (Vol. 2019).
- Alqahtani, A. Y., Kongar, E., Pochampally, K. K., & Gupta, S. M. (2019). *Responsible Manufacturing: Issues Pertaining to Sustainability*: Taylor & Francis.
- Kalayci, E., Avinc, O., Yavas, A., & Coskun, S. (2019). Responsible Textile Design and Manufacturing: Environmentally Conscious Material Selection. In A. Y. Alqahtani, E. Kongar, K. K. Pochampally & S. M. Gupta (Eds.), *Responsible Manufacturing: Issues Pertaining to Sustainability*: Taylor & Francis.
- Baldwin, S. (2018). Flexible Fabric Printing: Experiments In 3D Printing Over Fabric. In (Vol. 2019).

## INTELLIGENT TEXTILE MATERIALS

University lector, **Eugenia Elena Riemschneider**,  
West University, Faculty of Arts and Design, Timisoara, Romania

Keywords: intelligent textiles, fibre optics, research, innovation

### ABSTRACT

*Over the centuries craftsmen have wrapped golden and silver metallic sheets around the textile threads, obtaining like this new precious material.*

*The textiles which have evolved together with the new technologies offered special qualities for the textiles. The most research and commercialization projects of the ex textiles materials are hybrid. The intelligent textiles are materials which have-evolved together with the new technologies.*

*Heimtextil Frankfurt 2018, is the most important and the largest international fair where the international producers, the dealers and the designers present their products and their innovations to the commercial visitors. This year the innovative textiles where of great interest. Two companies came out: Schmitz Textile - a German company and Forster Rohner Textile Innovations – a Swiss company.*

*Schmitz Textiles, the German company with great tradition in the domain of the intelligent textiles, which combines the research with technical character, made by experts, with the progressive technology. The materials which result are used in the hotels domain on cruise ships, where the requirements are extremely strict.*

*Forster Rohner Textile Innovations combines the embroider technology with the textile and electronic science, by using conductive threads with heat sensors (Gore Tex equipment). The material which illuminates from the woven and very smooth threads with flat LEDs which do not come out are adequate fur curtains, bed blankets, materials which can separate the different zones of a space and which can be machine washed (30-40 degrees – delicate materials) by keeping its attributes.*

*Futurotextiles is the name of the exhibition which fascinates, because here you can see how the technological innovation achieves SF shares and is associated with art and with haute couture fashion.*

### 1. INTRODUCTION

Over the centuries craftsmen have wrapped golden and silver metallic sheets around the textile threads, obtaining like this new precious material The dresses of Queen Elisabeth I. were embroidered with golden threads.

At the end of the XIX century, the designers and the engineers began to combine electricity with clothes. In 1968 in New York was organized an exhibition Body Covering focused on the connection between technology and clothes. Also, the space costumes of the astronauts could be seen together with the clothing which could swell up and which could also deflate, it could light up, heat up and cool down.

The inventor Harry Wainwright in 1985, has created the first animated T-shirt of optical fibre and a microprocessor with which he could control the individual animation frames. He invented the first machine which could allow the introduction of the optical fibre to be processed in textiles.

At the initiative of Wainwright in 1997, Herbert Selbach, a German car constructor, realized the first CNC car capable to imply automatically the optical fibres in any flexible material.

The most research and commercialization projects of the ex textile materials are hybrid. The intelligent textiles evolved together with the new technologies.

You must take into account that the fibre from these textiles are stretched and bended while their usage and so they should be washable. In the present the electrical conductivity materials are of great interest. This is why the electrical components should be isolated while washing in order to prevent the deterioration.

The textile materials can be divided into groups which can:

- they improve the esthetical part – the materials which can change their color with the help of electronics, which gather energy from the environment by exploiting the vibrations, the sound or the heat.
- that of the performances for the usage in extreme sports and in military applications. These textiles adjust the body temperature, reduce the wind resistance and control the muscle vibrations – by improving the athletic performances.
- have hydration properties, perfumes and anti-aging.
- in the health industry the medical textiles which release drugs, medical devices for the monitoring of the patients.
- protection clothing, against the extreme dangers of the environment, like radiations or the effects of the space trip.

Heimtextil Frankfurt 2018 (9-12 January) is the biggest and most important international fair for home and exterior textiles. At this event the international producers, the dealers and the designers present their products and their innovations to the commercial visitors. It is the ideal place for establishing and maintaining the business contacts. This year at this international fair had also a special interest the innovative textiles. Two companies seemed interesting: Schmitz Textile – a German company and Forster Rohner Textile Innovations – a Swiss company.

## **2. SCHMITZ TEXTILES**

Schmitz Textiles a German company – a family business, with tradition in the domain of the intelligent textiles, by combining the research with technical character made by experts with the progressive technology. The result 3 brands

Quality without compromise, the effect is a perfect harmonized product, with intelligent functions and a high experimental value. These are: DRAPILUX (interior textiles), SWELA (exterior textiles), MOBILTEX (car textiles). “These materials with new functions are the result of some research, innovations which give functions of: fireproofing, cleaning the air, acoustic protection and bioactive.

We talk about intelligent textiles, which neutralize the unpleasant smells and protects against bacteria”<sup>1</sup> which not everybody can afford because of the price.

<sup>1</sup>Turp-Balazs Amelia, “Textile which illuminate and heat up and clean the air” in Dialog Textil –the textile industry magazine in Romania, nr. 2/2018-industry, pp.14

**2.1. The brand DRAPILUX** – interior textiles, are intelligent textiles with a large range of products destined for the horeca sector and corporates, for architects, hotels, and interior designers.



*Hotel room arranged with Drapilux materials<sup>2</sup>*

*The Brand Drapilux Flammestop* –are fireproof textiles obtained through the changings of the polyester which prevent the fire spreading.<sup>3</sup>

*The Brand Drapilux Air* – textiles with improvements that prevent the release of the unpleasant smells even after many washes.

*The Brand Drapilux Bioactive* - textiles which destroy all the bacteria because of the ion fibres of silver (used in health).

*The Brand Drapilux Akustic* – from special fibres which reduce the noise in the rooms, the echo.

All these materials are used in the hotel domain, on cruise ships where the needs are extremely strict.<sup>4</sup>

**2.2. The Brand SWELA** – produces exterior textiles, of superior quality resistant at optimal weather and offer:

- solar protection, a variety of options for an ultra-modern shadow. The polyester light transparent, permeable at air, contains a special property which prevents the penetration of filth in the textile. The Rayos materials do not spread, they maintain their form, their color and their residence for a long period of time. Some textiles are fireproof and aluminized in order to maintain the necessary quality for the professional use.<sup>5</sup>

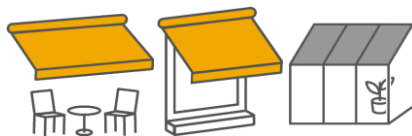

*Awnings*

*Greenhouse*

<sup>2</sup><https://en.drapilux.com/new-arrivals-2018>

<sup>3</sup><https://en.drapilux.com/>

<sup>4</sup><https://en.drapilux.com/products/more-just-fabric>

<sup>5</sup><https://www.swela.com/en/rayos-collection>

- the exposal of the material at air, radiations, moisture and microorganisms. The textiles from the collection Cielo are robuste, long lasting according to the industrial standards, repellent meaning they dry up fast and they allow the personalization with the swela print.<sup>6</sup>



*Sun umbrellas*

*Pergolas*

*Covers for exterior furniture<sup>7</sup>*

- the maritime textiles are equipped with special needs: resistance at rottenness, at weather (strong wind, together with strong sun), at breaking, shape retention, and bactericidal. They absorb hardly any salty-sweet water, they dry fast and they remain kore pleasant for a longer period of time.<sup>8</sup>



*Boat tilts<sup>9</sup>*

**2.3. The Brand MOBILTEX** – realizes textile for cars, necessary for the industry needs, train needs and airplane needs. The special characteristics of the MOBILTEX textiles are their mechanical, intelligent properties and their protection properties.

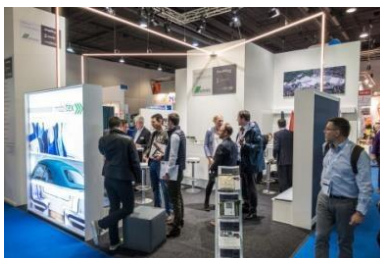

*The successful launch of the new brand mobiltex on Tectextil<sup>10</sup>*

<sup>6</sup><https://www.swela.com/en/cielo-0>

<sup>7</sup><https://www.swela.com/en/cielo-0>

<sup>8</sup><https://www.swela.com/en/maritime>

<sup>9</sup><https://www.swela.com/en/maritime>

<sup>10</sup><https://www.mobiltex-online.com/aktuelles/>

The waterproofing textile, has the role to protect the vehicle form filth, dust, to prevent fire and also the influences of the environment during all seasons.

The top priorities of the materials used in te airplane industry are the protection against fire and the weight reduction, as well as the resistance at the upper levels of the air pollution.<sup>11</sup>

### 3. FORSTER ROHNER TEXTILE INNOVATIONS

Forster Rohner Textile Innovations – a Swiss company with tradition in embroidery has presented at the Heimtextil fair this year the embroidery which illuminates with the help of the LED fibres – ebroidery. Their objective was the integration of the electronical functionalities in textiles, using the most recent generation of industrial embroidery machines, not equal in quality and productivity. Switzerland, China, Bosnia and Romania (Inter-Spitzen in Lugoj) are the facilities for an adaptable and efficient production from the point of view of the costs.

The main business of the firm is embroidery with LEDs and optical fibre as part of fashion. They work for designers as Dior, Chanel, Valentino, haute couture, but also ready to wear. They combine the embroidery technologies with the science of the textiles and the electronics, using conductor threads with heat sensors (GoreTex equipment). The material which illuminates from the threads are embroidered very fine with flat LEDs which do not stand out – curtains, bed blankets, the separation of the different zones form one space and which can be washed by machine (30-40 degrees- delicate materials) by keeping their properties.



*Material embroided with LEDs<sup>12</sup>*



*Arit, The Galaxie, www.arit.ch<sup>13</sup>*

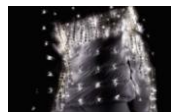

*Bogner, Shing Star, www.bogner.com<sup>14</sup>*

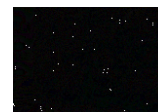

*e-broidery® ILLUMINATION  
 SATIN PRINT-SPHERE<sub>space</sub><sup>15</sup>*

<sup>11</sup><https://www.mobiltex-online.com/branchen/>

<sup>12</sup><http://www.frti.ch/en/technologie-2/>

<sup>13</sup><http://www.e-broidery.ch/en/projects/>

<sup>14</sup><http://www.e-broidery.ch/en/projects/#bogner>

<sup>15</sup><http://www.e-broidery.ch/en/>

The electronic textiles, known also as intelligent clothes, intelligent textiles are materials which allow digital components like a battery and a light (including small computers) and electronics which can be incorporated in them.<sup>16</sup>

#### 4. FUTUROTERTILES

**Futurotextiles** – is the name of the expo which fascinated me, because I saw how technological innovation achieves SF levels and is associated with the art and with the haute-couture fashion. In the fall of 2013, the halls TIMCO from Timișoara were the hosts of this important event, organized by the French Institute. There could be seen the innovators' creations from all over the world, of the engineers, of the artists but also of the designers. The accent was put on the natural fibres, on the very easy ones, on technological innovations. Daniel Ignat, then a student at the Faculty for Art and Design from Timisoara exposed a LED suit, which lighted up from the sounds around.<sup>17</sup>

Which was very interesting, was the composal of the expo in 3 parts:

- the pedagogical one, where the origins and the variety of the textiles were exposed



*The Halls TIMCO Timișoara*



*The expo with fibres, threads, composites*

- the scientific one, which brought out the future technology of the textile materials, fashion designers.



*Fluorescente textiles*

<sup>16</sup><https://en.wikipedia.org/wiki/E-textiles>

<sup>17</sup>[http://adevarul.ro/locale/timisoara/video-dantela-radacini-capsuni-rochia-creste-singura-intr-o-inedita-expozitie-timisoara-1\\_522dd80ac7b855ff5662fc3a/index.ht](http://adevarul.ro/locale/timisoara/video-dantela-radacini-capsuni-rochia-creste-singura-intr-o-inedita-expozitie-timisoara-1_522dd80ac7b855ff5662fc3a/index.ht)



- the artistical one, because the new fibres with their special properties are a source of inspiration for the



*The dress which protects you from pollution*



*The sweater which verifies the health<sup>18</sup>*

The origins of the fibres can be unusual but processed through various techniques of covering of the materials with protection layers, microcapsules, get new therapeutic, cosmetic, textile biosensorial, antibacterial properties.

**Conclusion:** Brightness and recyclability are the two essential elements of technical textiles that are increasingly used as materials of the future. Nothing gets thrown away – everything gets transformed!

#### **BIBLIOGRAPHY:**

Textile Dialogue The Textile Industry magazine from Romania, , Nr.1-2/2018

#### **WEBOGRAFY:**

<https://en.drapilux.com/new-arrivals-2018>

<https://en.drapilux.com/>

<https://en.drapilux.com/products/more-just-fabric>

<https://www.swela.com/en/rayos-collection>

<https://www.swela.com/en/cielo-0>

<https://www.swela.com/en/maritime>

<https://www.mobiltex-online.com/aktuelles/>

<https://www.mobiltex-online.com/branchen/>

<http://www.frti.ch/en/technologie-2/>

<http://www.e-broidery.ch/en/projects/>

<http://www.e-broidery.ch/en/projects/#bogner>

<http://www.e-broidery.ch/en/>

<https://en.wikipedia.org/wiki/E-textiles>

[http://adevarul.ro/locale/timisoara/video-dantela-radacini-capsuni-rochia-creste-singura-intr-o-inedita-expozitie-timisoara-1\\_522dd80ac7b855ff5662fc3a/index.html](http://adevarul.ro/locale/timisoara/video-dantela-radacini-capsuni-rochia-creste-singura-intr-o-inedita-expozitie-timisoara-1_522dd80ac7b855ff5662fc3a/index.html)

[http://adevarul.ro/locale/timisoara/foto-hainele-viitorului-expuse-timisoara-fost-deschisa-expozitia-futurotextiles-1\\_522f5f00c7b855ff566a79c2/index.html#photo-head](http://adevarul.ro/locale/timisoara/foto-hainele-viitorului-expuse-timisoara-fost-deschisa-expozitia-futurotextiles-1_522f5f00c7b855ff566a79c2/index.html#photo-head)

<sup>18</sup>[http://adevarul.ro/locale/timisoara/foto-hainele-viitorului-expuse-timisoara-fost-deschisa-expozitia-futurotextiles-1\\_522f5f00c7b855ff566a79c2/index.html#photo-head](http://adevarul.ro/locale/timisoara/foto-hainele-viitorului-expuse-timisoara-fost-deschisa-expozitia-futurotextiles-1_522f5f00c7b855ff566a79c2/index.html#photo-head)

## TEXTILE INDUSTRY IN BOSNIA AND HERZEGOVINA

**Samir Pačavar, PhD**  
**The Faculty of Technical Studies, University of Travnik, BiH**  
 Textile engineering and design  
[spacavar@bih.net.ba](mailto:spacavar@bih.net.ba)

### 1. INTRODUCTION

Bosnia and Herzegovina has a long tradition and good international reputation when it comes to the area of textile and clothing. Historically speaking, production dates from the beginning of the last century when it was based on vocational principles. Following the Second World War, this type of production was replaced by modern and contemporary textile facilities. In the last quarter of the past century, the number of workers in the textile and garment industry has been rapidly increasing. Smaller industrial plants were present in all regions of the country, while the creation of industrial conglomerates completely rounded out the production cycle, so that the textile production and manufacturing, as well as the production of final products were often a part of the same industrial whole.

Production of domestic clothing brands and the finishing or the so called *lohn* business had a ratio of 70:30, while placement of both types of products was possible on both the Yugoslavian and the worldwide market. At the beginning of the 1990s, most production plants were devastated. The market consisting of 22 million inhabitants ceased to exist, and the technological breakthrough in the post-war conditions was simply unrealistic. Transition which actually represents a change from the socialist, planned to the market economy implies one's own product design and a domestic brand which is competitive at the global market. If we talk about *lohn* business, it implies a company with a large number of well-trained workers and a modern technological park.

### 2. THE CURRENT STATE OF THE TEXTILE AND GARMENT INDUSTRY IN BIH

Following the war, the existing factories entirely turned towards *lohn* business for partners who primarily come from the European Union countries. The geographical position of Bosnia and Herzegovina simply suits them due to the short delivery time and experienced workforce with the necessary knowledge in the textile finishing business. It should be noted that the labour costs in the textile industry are extremely low.

*Table 1. The total foreign trade of Bosnia and Herzegovina in the leather, fur, textile and clothing sectors*

2017		2018		GROWTH %	
IMPORT	EXPORT	IMPORT	EXPORT	IMPORT	EXPORT
<b>2,052,266,419</b>	<b>1,495,058,673</b>	<b>2,058,484,214</b>	<b>1,596,557,831</b>	<b>0.30</b>	<b>6.79</b>

Table 2. The textile and clothing industry foreign trade for 2016/2017

Product name	Import	Export	Volume	Import coverage by export	Import	Export	Volume	Import coverage by export	2017/2016 Import	2017/2016 Export
Silk	1,784,044	9,470	1,793,514	0.53%	1,782,121	6,544	1,788,665	0.37%	-0.11	-30.90
Wool, fine or coarse animal hair, yarn and fabrics	47,027,731	836,444	47,864,175	1.78%	43,115,661	460,966	43,576,627	1.07%	-8.32	-44.89
Cotton	58,975,156	22,091,140	81,066,297	37.46%	62,371,596	15,331,805	77,703,401	24.58%	5.76	-30.60
Other plant-based textile fibres	969,322	42,957	1,012,278	4.43%	1,125,382	16,019	1,141,401	1.42%	16.10	-62.71
Artificial or synthetic filaments	93,938,468	7,019,479	100,957,947	7.47%	104,878,358	6,251,218	111,129,576	5.96%	11.65	-10.94
Artificial or synthetic fibres	82,485,180	18,640,309	101,125,489	22.60%	92,821,897	23,771,759	116,593,656	25.61%	12.53	27.53
Cotton wool, felt and non-woven materials, special yarns	77,012,590	1,934,991	78,947,581	2.51%	87,576,332	2,382,197	89,958,529	2.72%	13.72	23.11
Carpets and other floor coverings	33,705,691	719,616	34,425,307	2.13%	32,517,560	895,185	33,412,744	2.75%	-3.53	24.40
Special fabrics, taffeta fabric, lace	45,154,641	923,022	46,077,663	2.04%	44,046,245	1,167,270	45,213,515	2.65%	-2.45	26.46
Textile fabrics, impregnated, coated	159,043,023	21,315,602	180,358,625	13.40%	163,280,211	35,073,889	198,354,100	21.48%	2.66	64.55
Knitted or crocheted fabric	77,589,979	15,262,258	92,852,238	19.67%	103,076,597	5,501,917	108,578,514	5.34%	32.85	-63.95
Garments and clothing accessories, knitted or crocheted	169,970,858	134,722,822	304,693,679	79.26%	164,124,608	161,223,959	325,348,567	98.23%	-3.44	19.67
Garments and clothing accessories, except knitted or crocheted ones	207,569,119	281,897,880	489,466,999	135.81%	243,188,292	309,862,478	553,050,770	127.42%	17.16	9.92
Other final textile products, sets, worn-out clothes	57,723,460	18,607,875	76,331,335	32.24%	68,956,062	22,410,811	91,366,873	32.50%	19.46	20.44
Hats, caps and other headgear	5,314,112	3,535,518	8,849,630	66.53%	6,490,052	3,580,257	10,070,310	55.17%	22.13	1.27

*Table 3. The textile and clothing industry foreign trade for 2017/2018*

Product name	Import	Export	Volume	Import coverage by export	Import	Export	Volume	Import coverage by export	2017/2018 Import	2017/2018 Export
Silk	1,782,121	6,544	1,788,665	0.37%	510,215	27,730	537,945	5.43%	-71.37	323.77
Wool, fine or coarse animal hair, yarn and fabrics	3,115,661	460,966	43,576,627	1.07%	49,621,628	857,305	50,478,933	1.73%	15.09	85.98
Cotton	52,371,596	15,331,805	77,703,401	24.58%	62,202,936	14,276,955	76,479,891	22.95%	-0.27	-6.88
Other plant-based textile fibres	1,125,382	16,019	1,141,401	1.42%	1,764,094	14,420	1,778,514	0.82%	56.76	-9.98
Artificial or synthetic filaments	104,878,358	6,251,218	111,129,576	5.96%	108,541,376	7,120,014	115,661,390	6.56%	3.49	13.90
Artificial or synthetic fibres	2,821,897	23,771,759	116,593,656	25.61%	97,376,344	21,564,169	118,940,513	22.15%	4.91	-9.29
Cotton wool, felt and non-woven materials, special yarns	87,576,332	2,382,197	89,958,529	2.72%	83,750,310	2,146,750	85,897,060	2.56%	-4.37	-9.88
Carpets and other floor coverings	2,517,560	895,185	33,412,744	2.75%	42,100,727	2,674,215	44,774,942	6.35%	29.47	198.73
Special fabrics, taffeta fabric, lace	4,046,245	1,167,270	45,213,515	2.65%	49,753,420	2,897,137	52,650,557	5.82%	12.96	148.20
Textile fabrics, impregnated, coated	63,280,211	35,073,889	198,354,100	21.48%	141,409,034	22,963,459	164,372,494	16.24%	-13.39	-34.53
Knitted or crocheted fabric	103,076,597	5,501,917	108,578,514	5.34%	107,880,274	4,888,794	112,769,068	4.53%	4.66	-11.14
Garments and clothing accessories, knitted or crocheted	64,124,608	161,223,959	325,348,567	98.23%	196,355,827	186,174,466	382,530,294	94.81%	19.64	15.48
Garments and clothing accessories, except knitted or crocheted ones	243,188,292	309,862,478	553,050,770	127.42%	243,725,243	354,800,217	598,525,460	145.57%	0.22	14.50
Other final textile products, sets, worn-out clothes	8,956,062	22,410,811	91,366,873	32.50%	72,871,699	25,911,687	98,783,386	35.56%	5.68	15.62
Hats, caps and other headgear	6,490,052	3,580,257	10,070,310	55.17%	6,591,766	4,172,901	10,764,667	63.30%	1.57	16.55

### **3. ISSUES IN THE TEXTILE AND GARMENT INDUSTRY OF BOSNIA AND HERZEGOVINA**

In Bosnia and Herzegovina, over 40.000 workers are employed in the textile, leather and footwear sector, and there is no national development strategy for this sector or an institute dealing with this important industry.

It is extremely important to detect the real issues of the textile and garment industry in our country in order to find adequate solutions.

The textile and garment industry in BiH is highly dependent upon the major European clothing manufacturers. Often, large companies in BiH with a long-standing experience have major problems after cancelling orders placed by a foreign partner or decreasing the volume of the order at the last minute. On the contrary, partners most frequently demand companies from BiH to be the only contractors of the finishing works due to the larger production volume.

The domestic market is limited, and it is important to take into account the low level of consumer awareness in this country regarding the significance and importance of buying domestic products, and therefore investing in the national economy.

In addition, the domestic market faces the problem of illiquidity in companies distributing products to the end users.

The primary causes of the precarious state have to be sought in the very textile companies that do not adapt sufficiently to the current demands of a changeable market, neither trying to recognise future needs, modernise themselves and restructure their production, nor sufficiently invest in new materials, design and especially human resources.

The textile industry slowly responds to the fast market changes and buyers' demands, insufficiently applies the modern marketing methods, and, in some cases, has a management with a low level of education.

### **4. THE FUTURE OF THE TEXTILE AND GARMENT INDUSTRY DEVELOPMENT IN BIH**

The competitiveness of any product at the European market, including textile products from BiH, depends upon its design, quality and price. The design of textile materials is mostly affected by foreign suppliers because the domestic production has been reduced to a minimum. Domestic designers can improve the appearance of garments by using modern software for constructing, modelling and designing clothes.

The quality of producing garments depends upon the material, reproductive material, the technological park and the workers' skills. The price of human labour is still sufficiently low, enabling competitiveness at the global market.

The development of a new product does not exist without educated and highly-educated workforce. Human resources are the fundamental, exclusive and only intelligent element of the textile product manufacturing industry, and the companies in BiH increasingly express the need for quality and educated staff. Considering the low level of attraction for most vocations within this industry, it is necessary to organise different promotional activities in order to motivate young people to enrol in vocational secondary schools specialising in textiles. The currently low level of motivation primarily results from low income, unfavourable working conditions, standardised work, fixed-term and overtime work. The policy of textile companies should especially point out their orientation towards connecting with educational institutions and hiring workers educated in textile high schools and higher education institutions.

## 5. THE FACULTY OF TECHNICAL STUDIES

Since its inception, the Faculty has set standards placing students, their professional training and acquiring competences at the centre of attention, thus making them visible and competitive at the labour market. It built an environment where students create their own ideas with support from the Faculty which recognises their potentials and directs them towards excellence.

Through investing in modern equipment and monitoring trends in contemporary technology, the Faculty has created the conditions for using new education tools, making the students competitive at the labour markets in the region. The new education tools imply three levels of theoretical and professional training during the I cycle studies, while perfecting them at the master's studies.

Theoretical courses as the first level, practical courses at the Faculty as the second level and practical training as the third level are the tools available to our students. The fourth, preferred tool is EMPLOYING young people following their studies at the Faculty's own centres which represent ancillary departments, offering services to third parties.

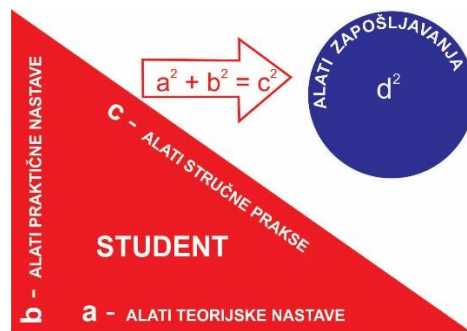

*Image 1. The TTP study model (theory, training and practice)*

The mission of the Faculty of Technical Studies' Department of Textile Engineering and Design is to educate staff of the textile profession, who will, alongside the obtained competences, skills and knowledge, initiate new fashion trends in addition to being ready to adapt and use new technologies which have a dynamic development and modalities, determining competitive advantage and quality at the labour market.

The Faculty's vision is to become a contemporary education centre which will, through its standards and quality criteria, stand out as a higher education institutions of world renown.

In the past, the Faculty has, since its inception, cooperated with the local community, both the narrow and wide one, and implemented a large number of projects with participation of the Faculty's students who have, through the projects, promoted their work and the Faculty's activities. The students are also included in scientific research, and, through team and individual activities, they participate at international assemblies and conferences, presenting their papers and projects.

The Faculty pays special attention to higher education quality assurance and the confirmation of its quality was certified by the accreditation seal obtained by the Faculty through institutional accreditation, registering the University of Travnik at the National Register of Accredited Higher Education Institutions in Bosnia and Herzegovina.

## EVOLUTION OF THE PERFORMANCE OF NON-PIEZO LAYERS ON FLEXIBLE PIEZOELECTRIC HARVESTERS

**Ramisa Yahyapour**

Textile Engineering Department, Amirkabir University, Tehran, Iran

[Ramisa.yahyapoor@yahoo.com](mailto:Ramisa.yahyapoor@yahoo.com)

**Mohammad Sajad Sorayani Bafqi**

1. Textile Engineering Department, Textile Research and Excellence, Centers, Amirkabir University of Technology, Tehran, Iran

2. Department of Civil and Industrial Engineering, University of Pisa, Pisa, Italy.

[S.Sorayani@aut.ac.ir](mailto:S.Sorayani@aut.ac.ir)

**Masoud Latifi**

Textile Engineering Department, Textile Research and Excellence, Centers, Amirkabir University of Technology, Tehran, Iran

[Latifi@aut.ac.ir](mailto:Latifi@aut.ac.ir)

**Roohollah Bagherzadeh**

.Institute for Advanced Textile Materials and Technology (ATMT), Textile Engineering Department, Amirkabir University of Technology, Tehran, Iran

\* [Bagherzadeh\\_r@aut.ac.ir](mailto:Bagherzadeh_r@aut.ac.ir)

### Abstract

*With recent advances in electronic technology, the market for wearable electronics grows rapidly. For mobile electronics, the integration of a wearable energy harvesting device would be the most promising way to supply the required energy. In the past decades, piezoelectric materials have attracted increasing attention as energy harvesting devices. One of the most important parameters for designing flexible piezoelectric generators is the effective conversion of the applied force to tension and strain. This is especially critical for the flexible piezoelectric generator where the strain/stress response maybe localized due to the essential softness of the material that can, in turn, limit the amount of electricity produced by the piezoelectric material. This paper attempts to use a non-piezo layer to improve the stress/strain distribution on piezoelectric layers while there are still flexible to improve the harvester's performance. The passive layers are used in different materials (aluminum, cellulose, polyester) and thickness (0, 120 and 420 um) and then the electrical output of samples were examined by PiezoTester. Results showed that the electrical output of the samples under tapping load strongly depends on the materials of the inactive layer.*

**Key words:** smart textiles, wearable electronic, energy harvesting, flexible piezoelectric, nanofibers.

### INTRODUCTION

With recent advances in electronic technology, the market for portable and wearable electronics grows rapidly. However, the use of a battery in such devices has been one of their major implementation problems due to its large size, the insufficient capacity, the danger of explosion, and the inconvenience of recharging. For mobile electronics, the integration of a wearable energy harvesting device would be the most promising way to solve these issues [Fan F. R. et al., 2016].

In the past decades, piezoelectric materials have attracted increasing attention as active material in piezoelectric devices such as self-powered sensors, actuators, piezotronics, and energy harvesting devices. Wearable and flexible piezoelectric energy harvesting devices which are capable to convert physical human body motions into electrical energy can be used as portable and sustainable energy sources for wearable or implantable electronic devices and smart textile.

In order to use these harvesters effectively, they should be fabricated from flexible materials such as PVDF nanofibers instead of brittle piezo ceramics [Chen X. et al., 2017] [Park K. I. et al., 2016].

Polyvinylidene fluoride (PVDF) is one of the most popular piezoelectric polymers due to its high flexibility, biocompatibility, and low cost. PVDF is a semi crystalline polymer that has four crystalline phases:  $\alpha$ ,  $\beta$ ,  $\gamma$ , and  $\delta$ . The non-polar  $\alpha$  phase is generally found in commercially available films, polymer solution and melting form. Dipole moments pointing have the same direction in the  $\beta$  phase; thus, this phase is the most important phase for piezoelectric properties of PVDF [Gee S. et al., 2018].

One of the most important parameters for designing flexible piezoelectric generators is the effective conversion of the applied force to tension and strain. This is especially critical for the flexible piezoelectric generator where the strain/stress response maybe localized due to the essential softness of the material that can, in turn, limit the amount of electricity produced by the piezoelectric material. Therefore, it is highly desirable to design the structure of the flexible piezoelectric generator in a way that the external force can be well-distributed across the entire piezoelectric layer to maximize the total power generation [Yang J. H. et al., 2016] [Jung W. S. et al., 2015].

In this paper is tried to use a non-piezo layer to improve the stress and load distribution across the piezoelectric layer while there are still flexible to improve the harvester's performance. The passive layers are used in different materials (aluminum, cellulose, polyester) and thickness (0, 120 and 420  $\mu\text{m}$ ) and then the electrical output of samples were examined by PiezoTester. The result showed that the electrical output of the samples under tapping load strongly depend on the materials of the inactive layer.

## MATERIALS AND METHODS

Fabrication of PVDF nanofiber mats (Figure 1) was started with dissolving PVDF (HaloPolymer© - 230.000 Mw) polymer (26% wt) in N, N-dimethylformamide (DMF) (Sigma Aldrich) and Acetone (Merck) (*Acetone/DMF*= 2/3) solvent. Nano fibrous mats fabricated by horizontal electrospinning (FNM© electrospinning system - Iran), (applied voltage: 18 KV, needle gage: 22G, cylindrical drum collector outer diameter: 26 cm, collector speed: 400 RPM, distance: 15 Cm and flow rate: 0.5 mL/h).

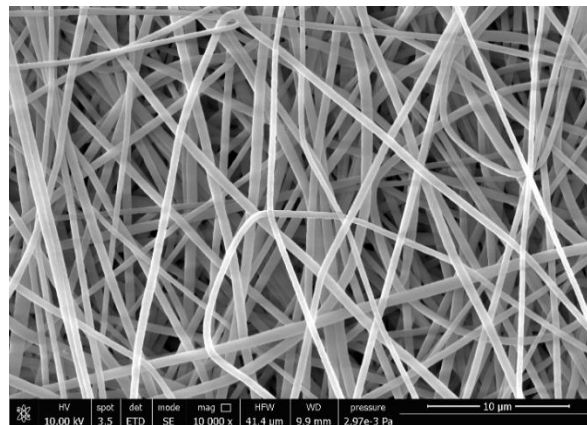

Figure 1: SEM image of PVDF nanofiber mat, Mean Diameter: 620 nm.

Samples, as an energy harvester, are fabricated (Figure 1) by two 2×2 cm nanofiber mats with 50  $\mu\text{m}$  thickness as active layers which are placed across a non-piezoelectric layer. A pair of thin aluminum foils are used as collectors as shown in Figure 2.



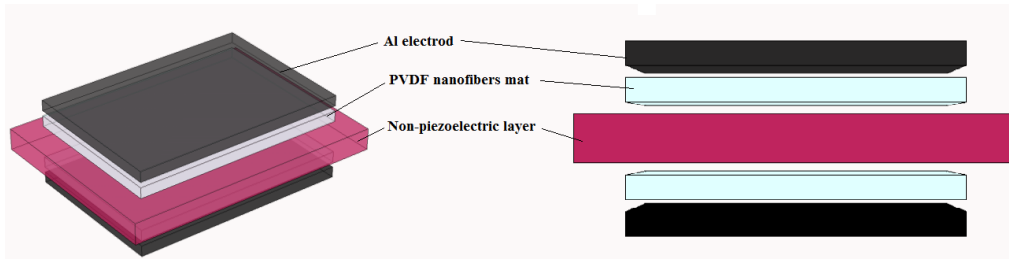

Figure 2: Schematic view of fabricated power harvester devices

Table 1: Properties of fabricated samples.

Sample's name	Material of non-piezo layer	Thickness of non-piezo layer
R1	-	-
R2	Aluminum	120 um
R3	Aluminum	420 um
R4	Cellulose	120 um
R5	Cellulose	420 um
R6	Polyester	120 um
R7	Polyester	420 um

Nanofibers crystalline structure was studied by XRD (Equinox 3000model, INEL France Co.) using Cu-K $\alpha$  radiation (wavelength 0.154 nm), and the samples were analyzed at room temperature. FTIR spectra of PVDF nanofibers were documented by Spectrometer (model: NEXUS 670, Nicolet Co.) over a range of 400–4000 cm<sup>-1</sup>. Melting temperature ( $T_m$ ), and melting enthalpy ( $\Delta H_m$ ) of electrospun nanofibers were measured with differential scanning calorimeter (DSC) (model: DSC 2010, TA Instruments.co) at a heating rate of 20 °C/min. the electrical output of the sample was measured by PiezoTester under a cyclic impact load with 5 Hz frequency and 2.56 N.

## RESULTS AND DISCUSSION

In order to ensure the crystalline structure properties, the electrospun mat initially was tested by crystalline analysis. DSC results showed that nanofiber mats have 51.4% crystallinity and the amount of  $\beta$  phase was 87% which calculated by FTIR. XRD results confirmed that the  $\beta$  phase of the crystalline structure of nanofiber is more than  $\alpha$  phase (Figure 3). Using these results, it can be stated that the produced layer has favorable piezoelectric properties.

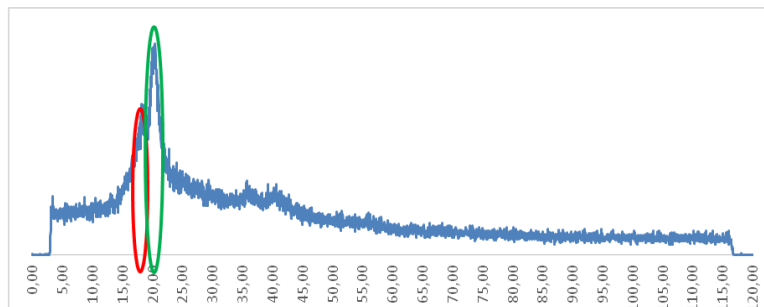

Figure 3: XRD result. Green marker related to angle 20.5 ° and beta phase, red indicator associated with angle 18.5 and alpha phase

Due to the direct piezoelectric effect, if mechanical stress is applied to a piezoelectric material, an electrical response will be obtained. For this reason, one of the important methods of studying the piezoelectric property and the performance of energy harvester is applying mechanical stress to the sample and measure its electrical output. PiezoTester method works based on this theory and electrical output of the sample were measured. For this purpose, 5 testers of  $2 \times 2$  cm in each sample were prepared with the thickness and layout indicated in Table 1. The average output of each sample is shown in the Table 2.

*Table 2: Electrical output under 2.5 N tapping load and 5 Hz frequency*

Sample's name	Average Output (mV)	Sensitivity (mV/N)
R1	130	49.06
R2	200	75.47
R3	260	98.11
R4	100	37.74
R5	160	60.38
R6	80	38.19
R7	180	67.92

As can be seen in Table 2, electrical outputs will be changed by adding a non-piezoelectric layer, but these changes vary depending on the materials of the inactive layer. In Aluminum layers, by adding the inactive layer and increasing the thickness of the layer, electrical output increases, but in cellulose and polyester layers it is different so that R4 and R6 outputs are even less than R1. The reason for these decreases in samples R4 and R6 can be attributed to the absorption of the applied force energy by the passive layer so that less energy is transferred to the piezoelectric substrate layer of the active layer and electrical output is reduced. In other words, it can be claimed that practically only one layer of piezo nanofibers is effectively active in the production of electrical energy. In aluminum inactive layer, the applied load is distributed more uniformly on the sample and electrical outputs are increased.

By increasing the thickness of the inactive layer from 120 to 420  $\mu\text{m}$ , in all materials, electrical output increases. In other words, it can be stated that the electrical output increases with an increasing thickness (in the given material).

The results showed that the electrical output of the samples under tapping load strongly depends on the material of the inactive layer. If the passive layer is a viscoelastic substance such as cellulose and polyester, with a high energy damping, the addition of the inactive layer will have a negative effect on output and will cause a drop in it. But if you use a rigid layer that has the ability to transfer and disturb the load, adding a non-active layer will increase the electrical output.

## CONCLUSIONS

In this paper is tried to use a non-piezo layer to improve the stress/strain distribution on piezoelectric layers while there are still flexible to improve the harvester's performance. The passive layers are used in different materials (aluminum, cellulose, polyester) and thickness (0, 120 and 420  $\mu\text{m}$ ) and then the electrical output of samples were examined by PiezoTester. Results showed that, electrical output of the samples under tapping load strongly depends on the material of the inactive layer. If the passive layer be a viscoelastic substance such as cellulose and polyester, with a high energy damping, the addition of the inactive layer will have a negative effect on output and will cause a drop in it.

But if you use a rigid layer that has the ability to transfer and disturb the load, adding a non-active layer will increase the electrical output. Also in a given material, increasing the thickness increases, the output.

## REFERENCES

Fan F. R., Tang W., Wang Z. L. (2016). Flexible Nanogenerators for Energy Harvesting and Self-Powered Electronics, *Advanced. Materials*, 28, 4283–4305.

Chen X., Li X., Shao J., An N., Tian H., Wang C., Han T., Wang L., Lu B. (2017). High-Performance Piezoelectric Nanogenerators with Imprinted P(VDF-TrFE)/BaTiO<sub>3</sub> Nanocomposite Micropillars for Self-Powered Flexible Sensors, *Small*, 13 (23), 1604245.

Park K. I., Jeong C. K., Kim N. K., Lee K. J. (2016). Stretchable piezoelectric nanocomposite generator, *Nano Convergence*, 3, 12.

Gee S., Johnson B., Smith A. L. (2018). Optimizing electrospinning parameters for piezoelectric PVDF nanofiber membranes, *Journal of Membrane Science*, 563, 804–812.

Yang J. H., Cho H. S., Park S. H., Song S. H., Yun K. S., Lee J. H. (2016). Effect of garment design on piezoelectricity harvesting from joint movement, *Smart Materials and Structures*, 25, 035012.

Jung W. S., Lee M. J., Kang M. G., Moon H. G., Yoon S. J., Baek S. H., Kang S. Y. (2015). Powerful curved piezoelectric generator for wearable applications, *Nano Energy*, 13, 174–181.

## HALENGES REVIEW ON FUNCTIONAL FIBROUS MATERIALS BASED ELECTRONICSKIN

**Niloufar Khomarloo**

Institute for Advanced Textile Materials and Technology (ATMT), Textile Engineering Department, Amirkabir University of Technology, Tehran, Iran  
[khomarloo1@gmail.com](mailto:khomarloo1@gmail.com)

**Roohollah Bagherzadeh\***

Institute for Advanced Textile Materials and Technology (ATMT), Textile Engineering Department, Amirkabir University of Technology, Tehran, Iran  
[bagherzadeh\\_r@aut.ac.ir](mailto:bagherzadeh_r@aut.ac.ir)

### ABSTRACT

*Human skin provides a remarkable network of sensors with highly sensitive pressure, temperature and vibration sensing. Skin can transduce environmental stimuli into physiological signals, which are then interpreted by brain. Electronic skin (e-skin) is an artificial skin that mimics the properties of skin using electronic devices. Inspired by human skin, e-skin has been found many potential applications such as wearable devices, artificial prosthetics, and health monitoring and smart robots. E-skin needs to be multifunctional system to mimic human skin. Functional fibrous materials have attracted huge interest for many applications due to their unique properties including: stretchability, high flexibility and most similar to the extracellular matrix of human skin which enable them to use as an artificial skin in many applications. In This paper we review the main challenges and requirements of fibrous based E-skin and focus on stretchability and transparency properties.*

**Key words:** Electronic skin, wearable device, stretchable, transparent, sensor

### INTRODUCTION

During the early stages of development, the incorporation of skin-like characteristics into conventional consumer electronics has mainly been hindered by their rigid and brittle nature, which renders them incapable of conforming to the dynamic surface of human skin and maintaining their functionalities. Although high performance inorganic nanomaterial-based skin-like devices have been realized, these devices still need to overcome the following three critical issues: low areal density, low stretchability, and low mechanical stability. Also many research groups have devoted their efforts to skin-like electronic devices that can maintain their electrical and mechanical performances even after being severed or cut, hence leading to the development of soft and robust skin inspired electronics[1] Skin-like electronics that can adhere seamlessly to human skin or within the body are highly desirable for applications such as health monitoring, medical treatment, medical implants and biological studies and for technologies that include human-machine interfaces, soft robotics and augmented reality[2].

Multi-functional electronic skin (e-skin) sensors, which can be directly skin-attachable to human body for normally monitoring the outside illumination environment and the movement situations of human body, can play a vital role in personal health and body rehabilitation. However, multi-functional e-skin sensors with transparency, stretchability, and skin-attachable to human body still keep challenge[3].

In recent years, there has been a large demand for stretchable and human-adaptive electronic skin due to its potential application in flexible wearable electronic devices, such as those in wearable health monitoring, prosthetics, medical diagnosis, and multifunctional robot skin.

To simulate the properties of human skin, artificial electronic skin needs to have the ability to monitor pressure, strain, flexion, movement, deformation, spatial pressure distribution, and even contactless sensing, such as finger proximity, by converting these physical deformations or noncontact signals into electrical signals.

In particular, a wearable and self-powered sensor combining all the merits of sensitivity, transparency, stretchability, and flexibility is highly demanded to adapt human skins [4], also a durable and sustainable power source, high response and recovery speeds, large-area applications, and low consumption and manufacturing costs to drive these electronic devices is still urgently needed [5].

In order to make artificial electronic skin that can meet these demands, various types of sensors have been developed. On the basis of their sensing mechanisms, these sensors can be divided into piezoresistive, capacitive, piezoelectric, and triboelectric sensors [2]. The two main sensing mechanisms that can be practically implemented in wearable applications are resistive and capacitive types. These two mechanisms require less complex measurement equipment and offer higher material flexibility compared to other types of sensors such as piezoelectric and **fiber Bragg grating**. However, due to the inherent limitations of capacitive-type sensors, their sensitivity is generally lower than that of the resistive ones. The main mechanism driving the piezoresistive effect resulting in contact resistance changes is the structural deformation of the sensing element. The change in contact resistance allows more tunable properties and has been widely used within different structures as flexible strain and pressure sensors including fibrous substrates, elastomeric nanocomposites, and conductive hydrogels [6].

## E-SKIN AS A SENSOR

Sensing the complex range of mechanical and thermal stimuli in skin requires multiple types of sensors. These different stimuli should be individually resolved, similar to biological skin in which there are selective sensors for skin sensations such as temperature and vibration. Multilayer artificial skins have been developed that sense multiple sensations. Measuring multiple stimuli using a single transducer can alleviate space constraints. However, to distinguish multiple stimuli, the device must include more than two terminals and include either comparative calculations or a biasing scheme that produces multiple measurable outputs. Artificial skins have also incorporated dedicated sensors for properties such as humidity that, in human skin, are instead estimated using combinations of receptors. It is currently unclear how the body would interpret information from sensors that are not typically found in skin [7].

*Table 1: Summary of selected demonstrations of electronic skin compared with human skin*

Technology	Sensor density (cm <sup>-2</sup> )					Electrical output	Multiplexing	Mechanics
	T	P	S	D	H			
Human fingertips <sup>20</sup>	4	70	48	163*	-	Digital	Direct address	Stretchable, durable, self-healing, biodegradable
Human palm <sup>20</sup>	4	8	16	34*	-	-	-	-
Stretchable carbon nanotubes <sup>44</sup>	-	25	-	-	-	Analog	Passive matrix	Stretchable
Self-healing sensor <sup>67</sup>	-	1	-	-	-	Analog	-	Self-healing
Biodegradable polymer <sup>70</sup>	-	13	-	-	-	Analog	Passive matrix	Biodegradable
Stretchable silicon <sup>75</sup>	11	44	44	-	1	Analog	Passive matrix	Stretchable
Piezotronic <sup>78</sup>	-	8,464	-	-	-	Analog	Passive matrix	Flexible
All-graphene <sup>89</sup>	25	25	-	-	25	Analog	Passive matrix	Stretchable
Carbon nanotube active matrix <sup>71</sup>	-	8.9	-	-	-	Analog	Active matrix	Flexible
Organic active matrix <sup>59</sup>	7.3	7.3	-	-	-	Analog	Active matrix	Flexible
Organic digital <sup>92</sup>	-	1	-	-	-	Digital	-	Flexible
POSFET <sup>723</sup>	-	-	-	100	-	Digital	Active matrix	Rigid silicon

The types of sensors are indicated by: T, temperature; P, pressure; S, strain; D, dynamic forces; H, humidity; POSFET = piezoelectric oxide semiconductor field-effect transistor<sup>26</sup>. \*Includes the added density of both FA-I and FA-II receptors.

Human body mechanical motions (such as walking and running, heartbeat, breathing, hand or limb movements, blood flow, stretching of muscles and skin) have huge untapped reservoirs of energy. Mechanical energy harvester such as triboelectric nanogenerator (TENG) can be effectively used to harness these energies. Triboelectric nanogenerator was first reported by Wang et al. in 2012 based on the coupling between electrostatic induction and triboelectric effect [8].

There has been a rapid rise in the development of triboelectric nanogenerators due to their potential applications in the field of energy harvesting and self-powered sensors for vibrations, accelerations, touches, pressures and other mechanical motions[9].In the next part we are going to review some of the studies in transparent, stretchable devices by different functionalities.

### ***Stretchability and transparency in electronic sensors***

Stretchable electronics that can mimic the fundamental characteristics of human skin are in great demand in robotics, electronic skin, artificial intelligence, diagnostics, prosthetics, human machine interfaces, and health monitoring technologies. In particular, a myriad of stretchable electronic devices have been developed by incorporating novel sensing materials, structural designs, and processing methods on stretchable substrates. Stretchable electronic devices mountable on human skin can meet the requirements for bending, twisting, stretching, and deforming into complex curvilinear shapes. Elastomeric materials including poly(dimethylsiloxane) (PDMS), polyurethane (PU), Ecoflex, and poly-(styrene-butadiene-styrene) have been used as stretchable substrates for the fabrication of stretchable electronic devices. To increase the stiffness and strength of elastomeric substrates, elastomeric matrices have been mixed with a second phase of nanofillers, such as carbon nanotubes, cross-linked membranes, graphene oxide (GO), graphene, or silica nanoparticles [10].

Wearable electronics have begun to spring up in various contexts including transistors, strain sensors, energy storage devices, and displays. For strain sensors, the properties of flexibility, stretchability and transparency are highly desired to adapt human skins. Several strategies have been developed to realize the stretchability of the active materials.

In particular, studies have doped conductive fillers, such as Ag ink, carbon nanotube (CNT), metal nanofibers/nanowires, and carbon black, into elastomer to form flexible electrodes. However, these flexible sensors suffer from poor transparency and stretchability due to the inherent color and inelasticity of conductive fillers. Comparably, transparent elastic conductive hydrogels doping high-concentration ions gain better transparency and stretchability, but dehydrated hydrogels become friable and opaque, losing their original transparency and stretchability. Alternatively, some researchers have adopted ionic liquids (ILs) as the active materials, but the liquid mass may give rise to instability issues, as well as signal hysteresis due to the channels encapsulating ILs.(21,23)

Reserchers incorporated IL-locked ionogel as the electrode and one electrification layer, which is coupled with another layer of patterned PDMS (molded from vinyl record) for triboelectrification. The unique mechanical properties of the ionogels and PDMS provide good stretchability and transparency to the sensor.

Moreover, owing to the nonvolatility of ILs, the ionogel maintains a high ionic conductivity to ensure stable performance of the sensor. PDMS is a common type of materials in biomedical applications and wearable devices because of its transparency, stretchability, biocompatibility and chemical stability. Moreover, its negativity in triboelectric series makes it a preferred material of TENG electrification layer[4].

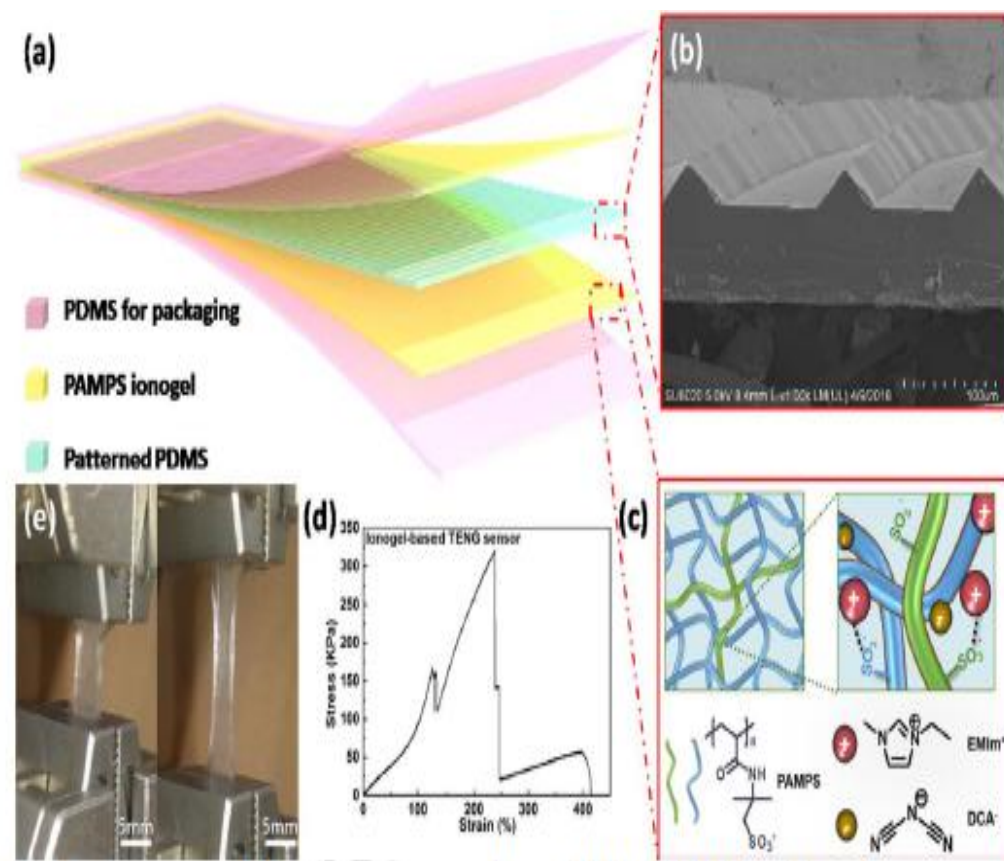

*Figure 1: structure of the transparent TENG-based tactile sensor. a) Layered structure of the sensor. b) SEM image of the patterned PDMS film with protruding triangular stripes. c) Molecular structure of the ionogel network. d) Stress-strain curve of the TENG based sensor. e) Photographs of the TENG sensor at original (left) and limiting length before breaking (right)[4]*

This sensor has high transparency (83%), good stretchability (121%), and good sensitivity to pressure (0.39~1.46 V·N<sup>-1</sup>) in the range of 0.1~1 N at different tensile ratios (0%~80%) and detects touching forces of different magnitudes, finger bending, human breathing, and pulse beating [4]. However, ionic dielectrics often exhibit impaired time response and large hysteresis, limiting their applicability in prosthetic electronic skin.

In another work, a transparent, stretchable humidity sensor was designed with a simple fabrication process, having intrinsically stretchable components that provide high stretchability, sensitivity, and stability along with fast response and relaxation time (Trung et al.,2017).

All the stretchable components were directly coated on the PDMS substrate, including the poly (3, 4-ethylenedioxythiophene) - poly (styrenesulfonate) (PEDOT: PSS)/PU dispersion (PUD) composite elastomeric conductor electrodes and the R-GO/PU nanocomposite sensing layer. A 200-nm-thick R-GO/PU composite sensing layer with an R-GO concentration of 10 wt% was selected for fabricating the stretchable humidity sensor. The fabricated device can be stretched up to a strain of 60% and it exhibits a high optical transparency with an average transmittance of approximately 78%.

This transparent, stretchable humidity sensor can be conformably wrapped around a human finger like a ring for continuously monitoring the humidity of the human breath, human skin, and the environment around the human body [11].

PVDF nanofibers by electrospinning are mainly used for piezoelectric sensors and piezoresistive sensor. Not only electrospinning process can effectively improve piezoelectric properties of nanofiber mats by changing the crystalline structure (e.g. create the  $\beta$ -phase) compared to PVDF film samples, but also the fibrous structure of these materials interestingly can be used in the wearable electronic textiles (Gheibi et al., 2014)[12]. An ultrathin and durable skin-like substrate was synthesized that was highly stretchable, optically transparent, tough, ultrathin, and had self-limiting characteristics was fabricated by incorporating P (VDF-TrFE) nanofibers with a high modulus and piezoelectricity into the low modulus matrix of PDMS (Hanif, A et al.,2018). P(VDFTrFE) nanofibers functioned as reinforcing fillers, which helped the skin-like substrate to mimic the mechanical behavior of human skin.

The piezoelectricity of the P(VDFTrFE) nanofibers enabled the skin-like substrate to detect dynamic pressure and strain. The skin-like substrate had a high optical transparency of 80%, and the stretchability, toughness, and Randomly distributed P(VDF-TrFE) nanofibers in the elastomer matrix conferred a self-limiting property to the skin-like substrate so that it can easily stretch at low strain but swiftly counteract rupturing in response to stretching. The stretchability, toughness, and Young's modulus of the ultrathin ( $\sim 62 \mu\text{m}$ ) skin-like substrate with high optical transparency could be tuned by controlling the loading of nanofibers. Moreover, the ultrathin skin-like substrate with a stretchable temperature sensor fabricated on it demonstrated the ability to accommodate bodily motion-induced strain in the sensor while maintaining its mechanosensory and thermosensory functionalities [10]. The primary structural layers in human skin include the epidermis, dermis, and subcutaneous layer and Transparent E\_skin is shown in fig 2.

A fully transparent, highly stretchable, and self-powered contact-separation triboelectric nanogenerator (TENG) wa reported as a tactile sensor (Zhao et al., 2019). An ultrathin and durable skin-like substrate that was highly stretchable, optically transparent, tough, ultrathin, and had self-limiting characteristics was designed by incorporating P (VDF-TrFE) nanofibers with a high modulus and piezoelectricity into the low modulus matrix of PDMS. P (VDFTrFE) nanofibers functioned as reinforcing fillers, which helped the skin-like substrate to mimic the mechanical behavior of human skin. The piezoelectricity of the P (VDFTrFE) nanofibers enabled the skin-like substrate to detect dynamic pressure and strain. The skin-like substrate had a high optical transparency of 80%, and the stretchability, toughness, and randomly distributed P (VDF-TrFE) nanofibers in the elastomer matrix conferred a self-limiting property to the skin-like substrate so that it can easily stretch at low strain but swiftly counteract rupturing in response to stretching. The stretchability, toughness, and Young's modulus of the ultrathin ( $\sim 62 \mu\text{m}$ ) skin-like substrate with high optical transparency could be tuned by controlling the loading of nanofibers.

Moreover, the ultrathin skin-like substrate with a stretchable temperature sensor fabricated on it demonstrated the ability to accommodate bodily motion-induced strain in the sensor while maintaining its mechanosensory and thermosensory functionalities [5]



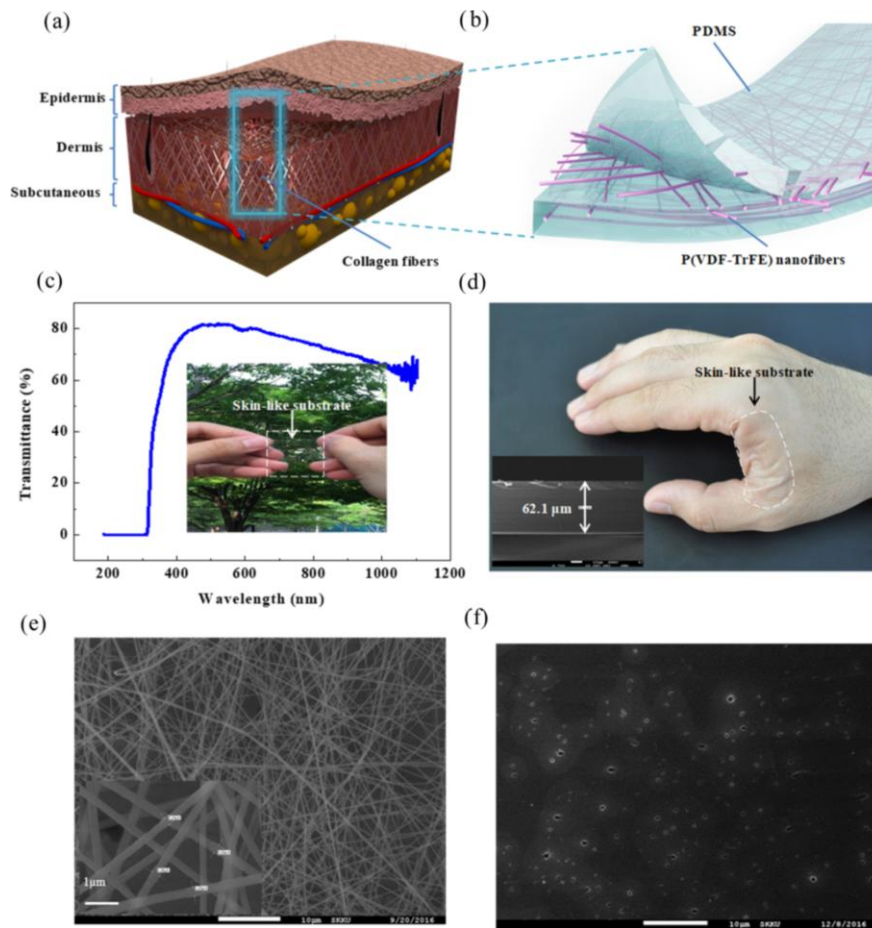

**Figure 2: Schematic and characteristics of a skin-like substrate.** (a) Schematic illustration of the structure of human skin. Human skin mechanical behavior is mainly controlled by the high-order network of collagen fibers in the dermal layer. (b) Schematic illustration of the ultrathin skin-like substrate. Randomly oriented P(VDF-TrFE) nanofibers as reinforcing fillers are embedded into a PDMS matrix to generate a stretchable, transparent, ultrathin, tough, self-limiting, and skin-like substrate that shows mechanical behavior that is similar to real human skin. (c) The optical transmittance of ultrathin and skin-like substrates. The inset figure (the scale bar is 10  $\mu\text{m}$ ) shows a photograph of the substrate, which was sufficiently transparent to allow clear visualization of the view behind the substrate. (d) The image demonstrates that the ultrathin skin-like substrate with a thickness of  $\sim 62 \mu\text{m}$  (inset) conformally attached on a human hand without detachment induced by repetitive skin deformation. (e) Top-view field emission scanning electron microscopy (FE-SEM) images of electrospun (ES) P(VDF-TrFE) nanofibers. High-magnification FE-SEM image is shown as an inset. (f) Cross-sectional FE-SEM image of the skin-like substrate showing uniform distribution of P(VDF-TrFE) nanofibers inside the PDMS polymer matrix. The nanofibers in the PDMS matrix were delineated by wet etching. The scale bars in (e) and (f) are 10  $\mu\text{m}$ .

## CHALLENGES, OUTLOOK AND FUTURE PERSPECTIVES

Direct incorporation of skin-like sensory function on/into an ultrathin substrate to mimic the ability of human skin to have self-limiting properties and deformability with the body movement while maintaining its sensing functionalities still remains challenging.

Also with increase development in functional fibrous materials it is very promising that these flexible and stretchable materials can be considered as a high potential material for developments of E-Skin technology.

## REFERENCES

1. Son, D. and Z. Bao, *Nanomaterials in Skin-Inspired Electronics: Toward Soft and Robust Skin-like Electronic Nanosystems*. ACS Nano, 2018. **12**(12): p. 11731-11739.
2. Wang, S., et al., *Skin electronics from scalable fabrication of an intrinsically stretchable transistor array*. Nature, 2018. **555**: p. 83.
3. Wang, Y., et al., *A highly stretchable, transparent, and conductive polymer*. Science Advances, 2017. **3**(3): p. e1602076.
4. Zhao, G., et al., *Transparent and stretchable triboelectric nanogenerator for self-powered tactile sensing*. Nano Energy, 2019. **59**: p. 302-310.
5. Zhao, S., et al., *All-Nanofiber-Based Ultralight Stretchable Triboelectric Nanogenerator for Self-Powered Wearable Electronics*. ACS Applied Energy Materials, 2018. **1**(5): p. 2326-2332.
6. Shi, H.H., et al., *Self-Assembled Nanorod Structures on Nanofibers for Textile Electrochemical Capacitor Electrodes with Intrinsic Tactile Sensing Capabilities*. ACS Applied Materials & Interfaces, 2018. **10**(22): p. 19037-19046.
7. Chortos, A., J. Liu, and Z. Bao, *Pursuing prosthetic electronic skin*. Nature Materials, 2016. **15**: p. 937.
8. Parida, K., et al., *Progress on triboelectric nanogenerator with stretchability, self-healability and bio-compatibility*. Vol. 59. 2019.
9. Garcia, C., et al., *Self-powered pressure sensor based on the triboelectric effect and its analysis using dynamic mechanical analysis*. Vol. 50. 2018. 401-409.
10. Hanif, A., et al., *Stretchable, Transparent, Tough, Ultrathin, and Self-limiting Skin-like Substrate for Stretchable Electronics*. ACS Applied Materials & Interfaces, 2018. **10**(32): p. 27297-27307.
11. Trung, T.Q., et al., *Transparent, stretchable, and rapid-response humidity sensor for body-attachable wearable electronics*. Nano Research, 2017. **10**(6): p. 2021-2033.
12. Gheibi, A., Latifi, M., Merati, A.A. et al. J Polym Res (2014) 21: 469.

## CRAFT & TRADITION: CHALLENGES OF REINTERPRETING NATIONAL HERITAGE IN FASHION AND TEXTILE DESIGN

**Edit Csanák**

Associate Professor, Óbuda University  
Sándor Rejtő Faculty of Light Industry and Environmental Engineering  
Institute of Product Design  
[csanak.edit@rkk.uni-obuda.hu](mailto:csanak.edit@rkk.uni-obuda.hu)

### ABSTRACT

*In this work, the author highlights the possibilities of reinterpretation of the national tradition, craft, and traditional folk motifs in product-, fashion- and textile design. Through the examples of student project works, writing presents the potentials of reinterpreting national heritage introducing the critical issues of the methodology, and describing the overall and specific methodological benefits of the work. The idea of sustainability guided the works and collections presented in this writing; some of them have been created in line with the tendencies of slow fashion. Examples of student works were realized at the Óbuda University in Budapest (Hungary); part of them were diploma works, and some were Project Works realized with international students, who participated in student exchange programs. The base assignment to the students was to make a research on a specific area of the traditions and national heritage, and after establishing the requirements and framing the design concept to prepare series of designs, produce mock-ups, samples or prototypes, and finally, to elaborate results in an essay. These requirements help specialized knowledge to integrate into a single project developing individual skills. As a unique feature, while learning about re-interpretation and application possibilities of folk motifs in different areas of design, and gaining knowledge in collection development and experiences vital for the profession, students familiarise with the culture, traditions, and heritage of a foreign nation.*

**Keywords:** national tradition, craft, heritage, folk motifs, project work methodology

### INTRODUCTION TO THE GENERAL CONTENT AND KEY CONCERNS OF THE COURSE

Project works provide an excellent opportunity for the development of personal skills; they stimulate problem-solving and self-esteem dexterities of the student, and support gaining confidence in different areas of the profession. Similarly to specific project tasks related to particular courses, and projects realized within the framework of the thesis or graduation masterwork courses, the University of Óbuda Sándor Rejtő Faculty of Light Industry and Environmental Engineering has successfully developed an eight-credit course 'Project Work' which is commonly chosen by the incoming students.

These last projects can be set up in different fields: Textile-, Garments, Paper-, or Printing design and technology, but also in Marketing, Quality, and Environmental Management, or Environmental Engineering – depending on the choice of the incoming student. Their content could be various:

- Making leaflets/posters, booklets or website with information on different topics;
- Design, or product of plans, portfolio for fabrics, garment, leather goods;
- Fashion product or collection;
- Methods, analyses, technology research at diverse fields of technical sciences, art and design.

The broad assignment to the students is to make applied research on a specific area, and after establishing the requirements and framing the design concept to prepare series of designs, to do experiments (mock-ups), to produce sample(s) or a prototype, and finally: to elaborate the results in an essay, and to present the achievements in PPT. The complexity of these tasks makes possible personal development in many areas. In addition to acquiring research and design methodology abilities, drawing skills and expertise in using CAD systems, as well as writing and performing skills became improved. Project works stimulate students for togetherness – which is a critical aspect of the integration of the international students, while the venues of the research work are completing their stay with meaningful experiences and pleasant social programs.

## THE METHODOLOGY GUIDED BY THE IDEA OF CULTURAL SUSTAINABILITY

Sustainability, respect for the cultural heritage and environment, as humanistic endeavors, play a significant role in the methodology of contemporary fashion and product design education, accordingly, the 'Project Work' course. Reinterpretation of the national tradition [1], and traditional technologies [2], craft and decoration [3], especially the application of the folk motifs, are continuously present in fashion and textile design and could be presented by numerous beautiful examples, and are examined in numerous studies. [4] [5]

Culture, as the continuously evolving dynamic interaction of mindsets and gut-sets of actors in the system(s), has many points of attachment to sustainability (cultural sustainability). For fashion and textile design, it means that *the cultural commitment of the designers and brands to sustainability is to create volumes with consideration of their responsibility for sustaining or continuing one's tradition, heritage, craftsmanship, method, and identity – as a part of this value.* [6] [7] The reinterpretation of the national heritage – folk motifs, traditional decoration, and crafting – are topics which constitute the core of the fashion design education methodology. [8] Driven by noble goals of sustainability of the fashion industry and Slow Fashion, the aspirations mentioned above are topics commonly chosen by the graduate students. A beautiful example is a student graduation work, made of hand embroidered home textiles (canvas decorated with Kalotaszegi motifs) in combination with cowhide. (See Fig. 1)



*Figure 1: Graduation project “Custom Bags Made by Recycling Embroidered Home Textiles” by Bálintné Pethő, 2017. Tutor: Dr. Edit Csanák (DLA)*

In the framework of the particular assignments, by the stylization of the traditional motifs, and by transmitting the traditional techniques to new technologies, students became familiar with a particular motif, and their application possibilities in fashion and textile design.

Example for this is a graduation project, in which a unique motif collection has been created by the stylization of Hungarian Art Nouveau motifs, for their further application in the collection, implemented by flocking technology. (Figure 2.)



Figure 2: Graduation project “Brand collection with flocked patterns” by Krisztina Szegedi, 2014; Some designs and the pattern collection. Tutor: Dr. Edit Csanák (DLA)

## METHODOLOGY OF SELECTED ERASMUS AND ERASMUS+ PROJECT WORKS

According to the general education goal, the *project must enable the student independently to carry out project work comprehending experimental, empirical, and theoretical investigation of one or more ways of presenting problems within central subjects of the student education.* In the case of international students of paramount importance is that during the research students become acquainted with the culture, traditions and national heritage of a foreign nation. Through the research, students learn about the Hungarian culture and traditions, learning the re-interpretation and application possibilities of the beautiful Hungarian national folk motifs in different areas of design. During the research in museums and city-libraries, their presence is supplemented by quality cultural programs. In this way, students will learn about the culture and customs of a nation while gaining valuable knowledge in the development of fashion and home textile collections and experiences necessary for their future professional life.

Topics of the practice work with terms and description of the tasks are usually detailed in the form of a ‘4 point schedule’ – in line with the general methodology of product design and product development. These are usually the following:

1. **Making of applied research** (on the latest fashion and commercial trends, market tendencies, customer behavior, etc.)
2. **Establishment of the requirements and specification the goals**
3. **Framing of the design concept:** Creation of mood-bards, sketches, and finally: presentation of the ideas in a series of fashion designs. Preparation of worksheets (technical drawings), and samples.
4. **Summarization of the experiences in an essay:** The research work, mood-boards, designs, and technical documents, photos about the workflow, and images of the ready samples if available.

**Design of packaging decorated with Hungarian folk art motifs for a winemaking startup – Academic Year 2013/14, II. semester and 2016/17, II. Semester**

Participants of the project were students from Poland, University of Lodz. The task was to decorate a gift-box for storage of smaller souvenir items with stylized Hungarian motifs. The students were asked to research souvenir shops in Budapest, to analyze the supply, and to make suggestions for possible expansion of the product range with simple packaging products, which will be decorated with Hungarian motifs. The students had to collect information about the Hungarian motifs in the Ethnographic Museum, and the University library. Emphasis was on simplicity, cost-effectiveness, and stylization; designs the drawings had to be done with the usage of CAD system (upon the choice of the student) and had to be portrayed on the virtual prototype.



*Figure 4: Designs of the packaging decorated with stylized Hungarian folk art motifs, and the virtual prototypes by Martyna Cichon, 2014. Tutor: Dr. Edit Csanák (DLA)*

The second project (Academic Year 2016/17, second semester) was realized with Erasmus+ students from Serbia, University of Novi Sad, Faculty of Technical Sciences Department of Graphic Engineering and Design. This time the task was designing of packaging for a start-up winery. The task was to create innovative paper packaging with in-part application of textile, and stylized Hungarian motifs. As an essential aspect, the low cost of the production had to be taken into account, which determined both the optional raw material and the production technology; the raw material (paper, cardboard, wood, and textiles) could not have been expensive – to maintain the product could be made at an affordable price, and the technology had to be easy-accessible, “average”.

The students had to summarize the task in the form of an essay, detailing the design process and their experiences. Finally, they have to prepare a paperback prototype of the designed product.



*Figure 5: Technical drawing of the selected packaging design decorated with Hungarian folk art motif, the virtual and the paperback prototype by Wolford Diana, 2017. Tutor: Dr. Edit Csanák (DLA)*

### **Accessory Collection for Brand ‘IKONIKA’ – Academic Year 2014/15, II. Semester**

Participants of this project work were Brazilian students, spending their four-week internship, as the final stage of their one-year academic study programme at Óbuda University Sándor Rejtő Faculty of Light Industry and Environmental Engineering, Institute of Product Design, in Budapest (Hungary). The assignment within the summer practice aimed to develop denim accessories for brand IKONIKA. The accessory range was created by the usage of recycled denim, with perspective to develop products which can be sold in boutiques, souvenir shops, or to use them as advertisement products for all sort of events. The motifs used for this collection were particular Hungarian folk motifs from the territory of Vojvodina (the northern province of the state Serbia). During the practical work, the students completed steps of product development in line with the general methodology, and from the phase of collecting inspiration, through the design process, making experiments, patterns, stencils for printing stencils, they could work together with their professor in a well-equipped workshop in Budapest. (Fig. 3)

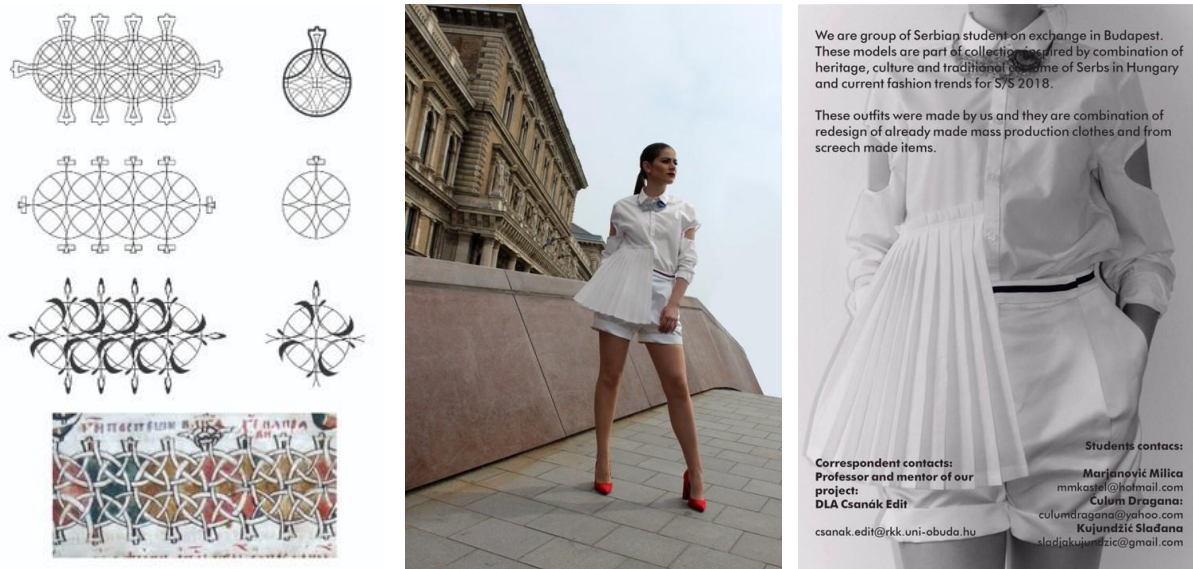

*Figure 3: Work with the Brazilian students in the workshop of the Lecturer, Dr. Edit Csanák (DLA) Moreover, designing of custom-producible hangtags (which can be inexpensively manufactured in a practical way – which means easy construction for significant quantities) was another task to the students, contributing to the improvement of their manual dexterity and creativity.*

***Designing of 2018 Spring-Summer Collection In Teamwork – Academic Year 2017/18, II. semester***

Participants of this project work were students on Erasmus+ student exchange from the Technical Faculty “Mihajlo Pupin” Department of Clothing Engineering from Zrenjanin (Serbia). The base assignment to students was to design a Spring/Summer 2018 collection inspired by the culture of the Serbs settled in the territory of Hungary. Specific task addressed to the student group was to organize their work in a team, correspondingly to a present-day fashion company. As part of the research, a particular mission was setting contact with the Serbian Cultural Centre, and learning more about the legendary institution of the Serbs, *Tekelijanum* in Budapest. In addition to library visits, making a trip to Szentendre and learning more about traditional Serbian villages (located in the north-eastern area along the Danube river near Budapest) it was also part of the assignment.

The joint work of the 8 students, who were on a different level of their studies<sup>21</sup>, resulted in a non-standard fashion collection. The central concept was to use four words that begin on letter S, an association to the coat of arms of the Serbian national flag and slogan of Serbs<sup>22</sup>, which was further developed by joint brainstorming of the team.



*Figure 4: Graphic designs, a campaign image and a flyer of the collection “4S” created by students Ana Ivanković, Anđelka Cvijetić, Dragana Čulum, Ivett Rác, Leposlava Lukić, Marica Pavlovic, Milica Marjanović, Slađana Kujundžić. Tutor: Dr. Edit Csanák (DLA)*

Students elaborated their cooperate work and experiences in a collective essay and showed the results in two events with great success: They participated at the National Conference of Scientific Students' Associations (OTDK, April 2018). Furthermore, they introduced their work at internationally recognized professional event Global Sustainable Fashion Week (GSFW, April 2018), which is well known in the world of sustainable fashion, representing their country, Serbia.<sup>23</sup>

<sup>21</sup> 5 students were at Bachelor (BA) studies, and 3 students are on Master (MA) studies; eight different opinions, attitudes, and characters, and different educational, cultural and aesthetical background.

<sup>22</sup> “*Samo sloga Srbina spašava!*” Which means: „Only the Unity Saves the Serbs!” The words picked for the names of the capsules were Serbia, Strong, Statement and Smart.

<sup>23</sup> Find more about this project in the referenced article. [9]



## 5 CONCLUSION

Following the guiding principles, projects provide an excellent platform for personal and professional development on many levels. They stimulate team working, problem-solving, self-esteem and confidence of the student. The project works also provide a possibility to learn more about a foreign culture, which is very important in educating cultural tolerance, since respect for the cultural heritage and environment, became important humanistic endeavors of our time.

Reinterpretation of the national heritage – folk motifs, traditional decorating methods, technologies, and crafting – are inspirations continuously present in fashion and textile design. Thus these topics constitute the core of the fashion design education methodology. Under the motto of slow fashion, ethical design, and sustainable development various project works can be realized by the fashion design and graphic design students, with will focus on a specific area of the heritage, reinterpreting it with a specific goal. Fields for application and the number of possible variations is practically endless; it allows students a wide range of application in diverse fields of design.

With their methodological advantages, last but not least, ‘Project Works’ based on cultural research plays a significant role in the acquaintance of the international students with the culture, traditions and national heritage of foreign nations and nationalities, and their culture.

## 6 REFERENCES

- [1] G. Oroszlány, “Az ír szteptánc-ruhák jellegzetességei - Characteristics of Irish step-dance clothes,” *MAGYAR TEXTILTECHNIKA (ON-LINE 2008-)*, vol. 63., pp. 168-172., 2010.
- [2] G. Oroszlány, “A zsinórok és paszományok készítésének technológiája, Zsinórkészítés,” *MAGYAR TEXTILTECHNIKA (1947-2005)*, vol. 57., no. 4., pp. 80-82., 2004..
- [3] G. Oroszlány, "PRESERVATION OF TRADITIONS USING INNOVATIVE TECHNOLOGIES," Budapest, 2015.
- [4] A. Mocenco, S. Olaru, G. Popescu and C. Ghituleasa, “ROMANIAN FOLKLORE MOTIFS IN FASHION DESIGN,” The UNIVERSITY OF ORADEA.
- [5] V. Petrovic, E. Csanák and M. Selak, “DESCRIPTION OF THE DEVELOPMENT OF INNOVATIVE PRODUCTS INSPIRED BY THE CULTURAL HERITAGE OF SERBIAN AND ROMANIAN PEOPLE,” Serbia, 2016.
- [6] E. Csanák, “Sustainable Fashion: Limiting a Singularity -Advanced Glossary to an Article,” *International Journal of Fashion Technology & Textile Engineering*, vol. 1., no. 1., pp. 1-5., 2018.
- [7] E. Csanák, “FENNTARTHATÓ DIVAT: EGY SZINGULARITÁS KORLATOZÁSA – SZÉLJEGYZET EGY CIKKHEZ,” in *Tudományos-, Műszaki és Művészeti Közlemények*, L. Koltai, Ed., Budapest, Óbudai Egyetem, 2018., pp. 135-143..
- [8] E. Csanák, *Kollekcióalakítás*, Budapest: NSZFI, 2015.
- [9] E. Csanák, “DESIGNING OF FASHION COLLECTION INSPIRED BY CULTURAL HERITAGE - METHODOLOGY AND RESULTS OF A PROJECT WORK,” in *University of Zagreb*, 2018.
- [10] E. Csanák, „ECO-FRIENDLY CONCEPTS AND ETHICAL MOVEMENTS IN THE FASHION INDUSTRY,” in *In: Zvonko, Dragcevic (eds.) Book of Proceedings of the 7th International Textile, Clothing & Design Conference: Magic World of Textiles*, Zagreb, 2014.

# **DESIGN AND DEVELOPMENT OF MANUAL HANK REELING MACHINE**

**Fitsum Etefa (B. Sc) Ethiopian Institute of Textile and Fashion Technology, EITEX, Bahir Dar University, Ethiopia, Oneday790@gmail.com**

## **FABRICATION OF MANUAL HANK REELING MACHINE**

### **INTRODUCTION**

The interest in producing textile product has increased significantly in the last few years. The abundance in nature combined with the ease of Textile processing was an attractive feature, which makes it an important income for the development of a given country. Now a day's different latest textile machineries are developed by different manufacturers. In production of yarn the main input fiber is changed into yarn by passing through different textile machinery. Hank reeling machine is used to change cone or cop packed yarn into a hank form by winding a yarn into a circular or round shaped reel. Hank yarn used to produce knitted and woven fabric.

### **1. ABSTRACT/PROJECT SUMMARY**

In today's Textile product processing, buyers are demanding lower prices, the best quality product and service. An effective cost reduction and higher productivity with short processing time is the main objective for textile manufacturer to be a strong competitor by having high market share with profitability and to compete successfully in the world market by keeping benefits of stoke holders including customers.

Now a day there is different manual and automatic hank reeling machine. Automatic hank reeling machine which works by help of electrical system and have its own motor for winding. This machine can produce maximum number of hank within one cycle of production and its less time consuming. But to purchase this machine it is expensive.

Manual hank reeling machine can wind single hank per cycle and its time consuming than automatic reeling machine. To solve this problem, I have designed manual hank reeling machine which can be driven easily by using foot. This machine can wind up to 12 hanks within single cycle of production time. To fabricate this easily operated manual hank reeling machine costs 14,930 Ethiopian Birr. The hank that we got from this machine is can be easily un-winded during woven and knitted fabric production.

### **2. PROJECT JUSTIFICATION**

Now a day there is different manual and latest automatic hank reeling machine. Automatic hank reeling machine works by help of electrical system and have its own motor for winding. This machine can produce maximum number of hank within one cycle of production and its less time consuming. To purchase this machine it cost more than 100,000 Ethiopian Birr.

Manual type hand driven hank forming machine can produce only one hank in one cycle and it can be driven by hand. Manual hand driven hank reeling can produce single hank within single production cycle and have less production.

My new manual hank reeling machine can produce up to 10 hanks within one production cycle. This manual hank reeling machine can be driven easily by foot and it gives comfort for operator. The cost to fabricate this machine is very less when compared with mechanical hank reeling machine.

To fabricate this machine it costs 14,930 Ethiopian. This manual hank reeling machine has a long shaft, on which the reel is welded and the shaft is supported by two bearing with their housing. The one side shaft is connected with the driving unit by belt. When the driving unit rotates, the reel which is fixed on the shaft starts winding the cone or cop shaped yarn into the reel to form a hank.

This machine has a feeding unit, which used to feed cone or cop packed yarn to the winding unit. There is a traverse, which used to distribute the yarn along the hank width. There is rotated worm gear, which have 100 teeth. The worm gear is connected with the shaft by belt. This worm gear used as a cam, when the shaft rotates one cycle, one of the worm gear teeth forward. On the worm gear there is a small length rod, which is welded on it. There is a traverse rod on which a key tongue is connected, when the worm gear forward one teeth, a small rod on the worm gear will push a key tongue. Finally, when the rod traverse, the yarn which passes through a yarn feed can traverse together and the yarn will distributed uniformly to form a hank.

## **2.1. Problem statement**

In Ethiopia, Textile product manufacturing is one of a key sector that identified by the government since 2010. The Ethiopia industrialization strategy has given top priority to textile product processing. The several opportunity and suitability of the general atmosphere for the growth of textile industries in the country some local and foreign investors are investing their knowledge and capital in textile industry. In Ethiopia there are large number of small scale knitted and woven fabric producers. To produce these fabrics the main input they using is hank yarn.

Now a day there is different manual and automatic hank reeling machine. Automatic hank reeling machine works by help of electrical system and have its own motor for winding. This machine can produce maximum number of hank within one cycle of production and its less time consuming. But to purchase this machine it is expensive. Manual hank reeling machine can wind single hank per cycle and its time consuming.

Local knitted and woven fabric producers can purchase a cop packed yarn from market and they change into hank form by using small manual hand driven hank reeling machine. However, the amount of hank produced by manual reeling machine does not satisfy the need of small scale knitted and woven fabric producers and it leads the hank cost very high. Therefore, this problem was a notable hindrance limiting the industrial growth of the country. In my research, I have concerned on fabricating of easily operated manual reeling machine with less manufacturing cost and which rotates by using foot and can wind more number of hank per cycle.

## **2.2. Priority needs**

- Create job opportunities: In our country there is high number of small scale fabric producers. Fabricating high number of hank reeling machine can create job opportunity for community.
- Better value additions: Hand driven manual hank reeling machine can produce single hank per cycle, but my new manual hank reeling machine can produce up to 10 hanks per production cycle.
- Improve product quality: During the production of hank the yarn will distributed in parallel way, so during un-winding the hank, It cannot cross linked.

### **2.3. Proposed approach**

This project mainly concerned on improving manual hank reeling machine, by changing some mechanism of reeling process. In manual hank reeling the operator uses its hand to wind and can wind single hank per cycle and its time consuming. To solve this problem, I have changed the driving unit from hand to foot and I have extended the width of reel to wind up to 10 hanks per single production cycle. This gives comfort for the operator, because the operator has a possibility to drive the reel by his foot, by sitting on a table. Fabricating many number of this reeling machine can create a job opportunity for machine fabricator and machine users.

### **2.4. Implementing project team**

I have started this project in 2006 E.C with my friend when we were students under research and innovation center. We have done the first manual foot driven hank reeling machine. Then we get different comments for improvement of some parts from different staff members. Then by taking comments we start fabricating this machine in 2007 E.C and we have done based on the comment that we have received from staff members.

## **3. PROJECT GOAL**

My research is concerned on fabricating easily operated manual hank reeling machine. The mechanism that used to produce hank is easy and can process 7 hanks within a single production cycle. In this research I have concerned on reducing those problems which influence hank production.

- To increase knitted and woven fabric production.
- To create safe working environment.
- To improve entrepreneurship skill of students.
- To create good working environment between the university and society.
- To increase in productivity of fabric producers.
- To increase quality of products.
- To minimize operation cost.

### **3.1. Project objective**

The main objective of my research is concerned on fabrication of easily operated manual hank reeling machine with a minimum manufacturing cost.

#### **Specific problem**

- Increasing number of hank producer per cycle.
- Minimizing production time and labor cost.
- Producing easily operated hank reeling machine.
- Producing uniformly distributed hank yarn.

### 3.2. Project Design Design of machine parts

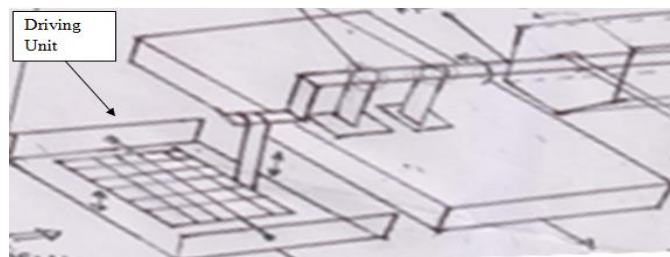
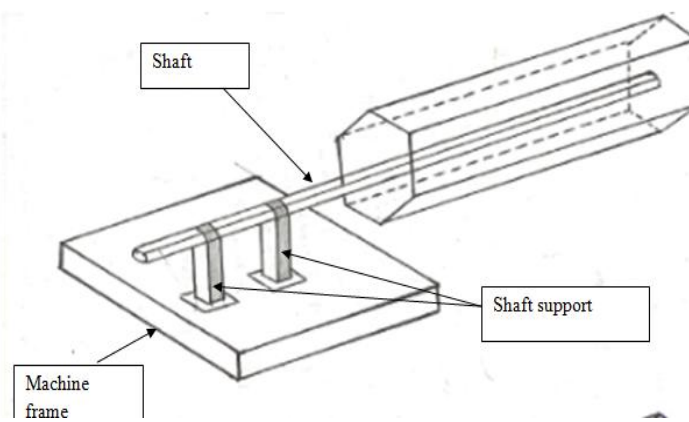
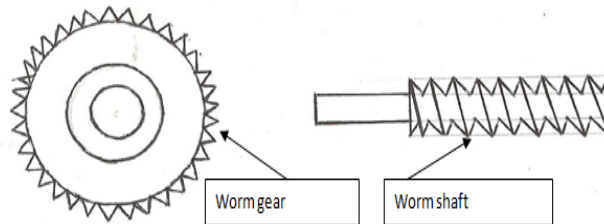
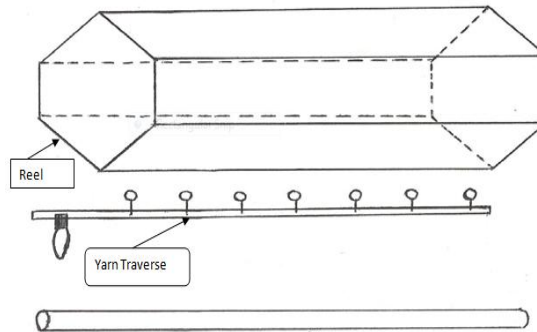

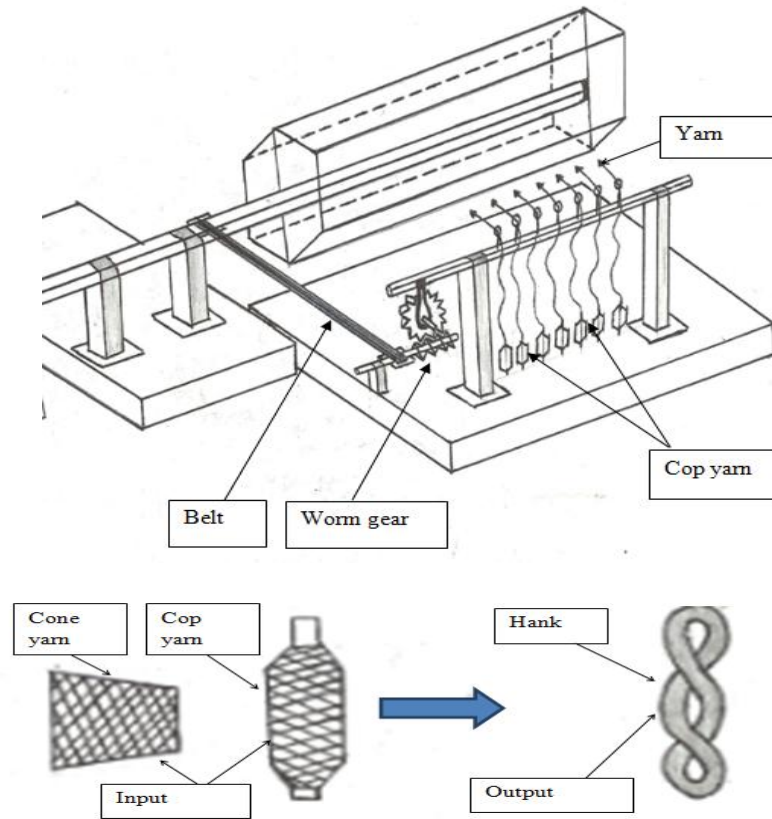

Machine Description

No.	Machine parts	Dimension	Material Type
1	Reel	Length 90cm, circumference 80 cm	10mm Round bar
2	Reel support	Length 50 cm	CHS pipe 50*2
3	Traverse support	Length 65 cm	CHS Pipe 25*1.25
4	Yarn Traverse	Length 110 cm	
5	Reel Frame	60cm*40cm	Tubular steel
6	Feeding frame	110cm*60cm	Tubular steel
7	Shaft	Length 160 cm	CHS pipe 25*1.25

### Machine specification

S/N	Specification	Description
1	Type of machine	Manual hank reeling machine
2	Number of hank produced per cycle	12
3	Working condition	Manually
4	Number of operator	Single
5	Spinning method	Winding
6	Material input	Cone or cop packed yarn
7	Material output	Hank yarn
8	Maintenance system used	Oiling and cleaning
9	Swift circumference	1.2meter
10	Length of machine	1.8 meter
11	Width of machine	1.1meter
12	Height of machine	1meter

### 3.3 Project outcome





*Design of Manual hank reeling machine*

#### **4. TARGET GROUP/BENEFICIARY**

- Used for Small scale enterprises.
- Used for hank yarn suppliers.
- Used for local fabric producers.
- Upgrade entrepreneurs of Students.

#### **REFERENCES**

Research project: Design and development of manual hank reeling machine



## **TEXTILE AND GARMENT INDUSTRIES IN ETHIOPIA**

**Gebregziabher Kidus Tesfamariam**  
SUMEC ETHIOPIA TEXTILE and GARMENTS MANUFACTURING PLC

### **INTRODUCTION**

Globally the textile industry in general and that of apparel and garment industry in particular has an expanding market. The industry touches the lives of all people in one or the other ways .apparel, home textiles, technical textiles, industrial textiles, medical textiles, safety textiles, smart or intelligent textiles, there are variations for all consumers, traders, manufacturers, technologists, engineers and others.

The textile and garment industry has come a long way to be an organized industry from being a mere domestic industry .starting with the industrial revolution; it has gained a state of supremacy with time. high production of wool, cotton and silk all over the world has given a boost to the industry in past years .though the industry originated in UK, the Art of textile production passed to Europe and north America after mechanization of textile manufacturing process in those areas .Asian countries also industrialized their economies and took steps for the growth of this sector. Japan, India, Hong Kong and China have become leading producers of textile because of the availability of cheap labor which is a very important factor for this industry.

The textile and garment industry plays a significant role in the development process of both developed and developing countries .with its intensive use of relatively low skilled labor, the sector has been important in the process industrial development ,provides employment opportunities create forward and backward linkage in the potential resources utilization for countries like Ethiopia.

In addition to the opportunities and challenges offered by globalization recent changes in global trading rules have brought some additional opportunities for developing countries specially in Africa .one example is the ‘‘African growth and Opportunities Act’’(AGOA) facilitating access to the large US market for a range of goods .similarly, trade arrangements on a global scale (WTO and EU’s everything – but Arms ,EBA),and on a regional scale (COMESA),which also have the potential to promote exports.

Many scholars agree that there is no single country which developed its economy without using the textile and garment industry as a stepping stone. The textile industry specifically the apparel and garment industry is a labor intensive industry and creates employment opportunity more than any industry in an Economy.Clothing is a basic human need and one of the first manufacturing activities established in the process of industrialization .hence, the market for garment and wearing apparel is always sustainable next to food.

Ethiopia is a land of great diversity .it has a number of agro –ecologies, ranging from arid lowlands (below 1500 meters below sea levels to per humid highlands (above 2300 meters above sea level),with great variations in temperature and rainfall.

With these agro-ecological zones Ethiopia is supposed to have huge potential for textile garment as it can produce one of the finest raw materials of the industry i.e. cotton, both in quality and quantity wise using its varied agro-ecological zone. However, the development so far is far lower than the estimated potential. The government Ethiopia has identified the industry as one of the most important ,to enhance the country 's economic development .Ethiopia has one of the largest labor force markets in sub Saharan Africa and the Government has planned to use this opportunities to attract foreign direct investment to boost the textile and garment industry .as a result ,the industry holds great potential for private investments .therefore ,it is essential to enlarge and develop the industry's products both in quality as well as in quantity to benefit the private investors specifically and the economy at large.

What can be the factors for the demand of the textile and garment???

## **1. GLOBAL POPULATION GROWTH**

Next to food and shelter ,clothing is a basic human need and one of the most traded commodities in the international market .thus, as population grows, aggregate demand for apparel and garment rises.

## **2. ECONOMIC GROWTH**

The quantity demanded for apparel and garment increases with the rise in income until the income elasticity of demand for the goods reaches zero. This shows that there is a direct relationship between economic growth and the demand for apparel and garment.

## **3. GLOBAL TRADE BARRIERS**

Global trade barriers is an important economic variable that influences the sale and purchase of apparel and garment products .Trade barrier between two countries seriously influences the cost of imports and increases their prices as well.as a result ,the imports would become less competitive in the market .

In this regard, garment and apparel products from developing countries enjoy different opportunities among others are the Africa growth and opportunity act (AGOA) of the united states of America government and Everything but Arms (EBA) of the European union .these opportunities are expected to increase the competitiveness of the garment and apparel products of least developed countries and hence increase their demand as well.

#### **4. SELLING PRICE**

Price is another factor determining the quantity demanded of a product .the lower the price of a product, the higher the demand for it and hence enable the supplier to penetrate in to the market and increases its market share.

## SEAM PUCKERING OF COTTON SHIRT AFTER LAUNDERING

Emilija Toshikj\*, Goran Demboski, Igor Jordanov, Biljana Mangovska

Ss. Cyril and Methodius University, Faculty of Technology and Metallurgy, Ruger Boskovic 16, 1000 Skopje, Macedonia

e-mail: tosic\_emilija@tmf.ukim.edu.mk

### ABSTRACT

*Plain cotton fabrics commercially available for manufacturing man's shirts, were seamed by applying three types of seams. The seaming was conducted on an industrial sewing machine under the sewing parameters commercially adopted by apparel manufacturers. The selected samples were laundered three times with two different commercially available detergents under same washing conditions. The seam puckering were analyzed before and after the laundering. It was found out that the degree of seam puckering after the laundering was affected by the type of seam and detergent used.*

**Key words:** cotton shirt, seam pucker, safety seam, French seam, English seam,

### INTRODUCTION

Shirt related manufacturing industry is facing an era in which the quality, cost and compliance of the production have been receiving a paramount importance. Apparently better quality and lower cost are the most basic factors for the market success. Seam pucker is one of the major problems the garment and particularly shirt industry has been facing with for many years (Kung J. T. et al., 2005; Dobilaitė V. et al., 2013). Seam puckering is the most prominent aspect of seam which hinders the aesthetic appeal of the seam. The seam puckering phenomenon is defined as a local defect of a clothing item in the form of large ripples of material beside the seam and is considered one of the most serious defects in shirt manufacturing. Factors affecting seam pucker are: sewing thread, fabric characteristics, stitch formation, sewing thread tension, fabric feeding and seam type (Fan J. et al., 1998; Dobilaitė V. et al., 2006). Seam thread properties, sewing parameters and their compatibility during the sewing have been investigated in several papers (Mori M. et al., 1997; Rudolf A. et al., 2007; Fathy Sayed Ebrahim F., 2012; Rudilf A. et al., 2012; Choudhary A. K. et al., 2013). Superimposed and lapped seams are the most frequently used seam classes in shirt manufacturing, from plain, safety, French, to English and other types of seams. Since shirts are usually worn seven or more than seven hours a day, they should be frequently changed and properly cared for. Laundering is a part of the dress shirt care (Bishop D. P., 1995). The shrinkage of fabric after laundering may have a considerable influence on seam pucker.

The goal of this research was to examine seam puckering of cotton shirt fabrics influenced by seam type, laundering and detergent type. The detergent selected for the laundering procedure had different formulation and were commercially available.

### EXPERIMENTAL PART

#### Materials

Plane woven fabrics made of 100 % cotton or of a cotton/lycra blend, of white or light colour and various weight, intended for man's shirts, were seamed and analyzed. The seam types applied were as follows: safety seam, double lap of French seam and English seam (Figure 1).

Shirt fabrics have fabric weight between 72 and 125 g/m<sup>2</sup>, fabric thickness between 0.22 and 0.35 mm, warp fabric density between 47 and 57 cm<sup>-1</sup> and weft fabric density between 25-36 cm<sup>-1</sup>. The test specimens were prepared in warp direction according to the AATCC Test Method 88B (2006). The sewing was performed using sewing machines with industrial settings. The samples (with and without seams) were subjected to 3 washing cycles, using two detergents with different formulations.

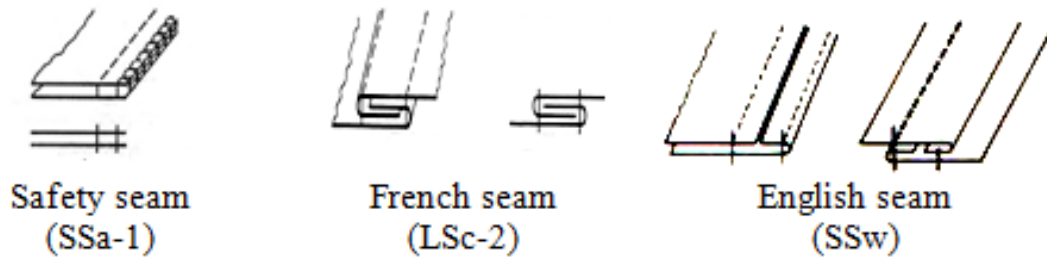

*Figure 1: Investigated seam types*

### **Laundering procedure**

The laundering was carried out using a front loading domestic washing machine with a horizontal axis under the following conditions: total load weight 1.8 kg at 60 °C for 106 min. The detergents selected for the laundering procedure had different formulations and were commercially available. The powder detergent (P) was with bleaching agent and optical brighteners, while liquid detergent (L) was without bleaching agent and optical brighteners. The laundering was carried out according to standard AATCC 88B (2006).

### **Testing methods**

The seam puckering of cotton shirt fabric before and after laundering was analyzed depending on seam type, laundering process and detergent type. Shrinkage of samples after third washing cycles with powder and liquid detergents was also analyzed. Shrinkage after laundering was determined according to EN 25077 25077 by measuring the samples before and after laundering and calculated using following equation:

$$S = \frac{L_0 - L}{L_0} \cdot 100 (\%)$$

Where:  $L_0$  is the distance between mark lines before laundering and  $L$  is after laundering.

Seam pucker of samples was assessed before and after the third washing cycle with two different detergents according to standard AATCC 88B (2006). The evaluation of seam pucker is done by three observer. Each seam is marked as equivalent in appearance to one photographic standard, where 5 indicates the best, non-puckered seam, and 1 is the worst. Average values are then calculated from the samples. Figure 2 shows a ration system for seam puckering from 1 to 5 with 5 being pucker free.

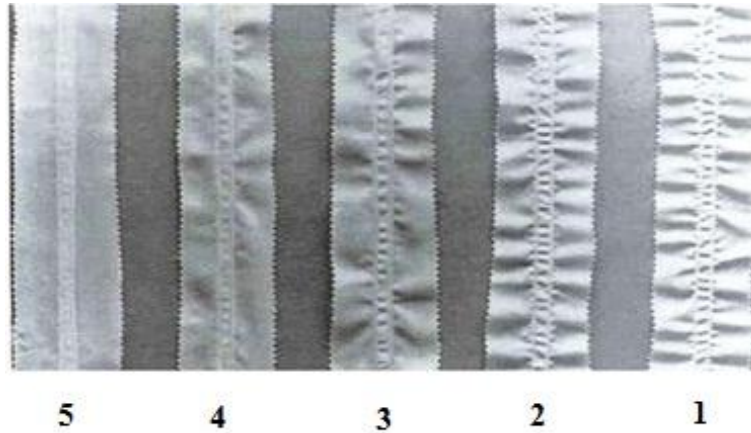

Figure 2: AATCC photographic of seam puckering rating

## RESULTS AND DISCUSSION

The results of subjectively evaluating the seam pucker for the analyzed seam types at the initial stages of fabrics are shown in Table 1. Grade 5 represents the best level of seam appearance, while grade 1 represents the worst one. The average values of seam pucker for the analyzed seam types are presented in Figure 3. The results in Figure 3 show that the English seam determined the smallest seam puckering, followed by the French and safety seams.

Table 1: Seam pucker of referent fabrics (R) and fabrics laundered with powder (P) and liquid (L) detergents as a function of seam type

No.	Seam pucker grade								
	Safety			French			English		
	R	P	L	R	P	L	R	P	L
A	2	2	2.5	2.33	1	2	3.33	2	3
B	1.66	3	3	3	2.67	3	3.66	3	3
C	3.33	4	4	4	2.67	3.33	4	3	3.33
D	2.33	4	3.5	4	2.33	3.67	4	2.67	3.67
E	3.17	3.5	4	3.33	2	3	4	2.33	3
F	2.66	3	3	2.33	2	2	4	3	3
G	2.67	3	3	4	2.67	2.33	4.33	3	2.33
H	2.66	3	3	3.33	1.33	2	4	2	3
I	3.33	2	3	3	1	3	3.33	2	3
J	2.66	3	4	3.6	3.33	3	4.66	3	3
K	2.75	3	3	4	2.5	4	4	3	2.5

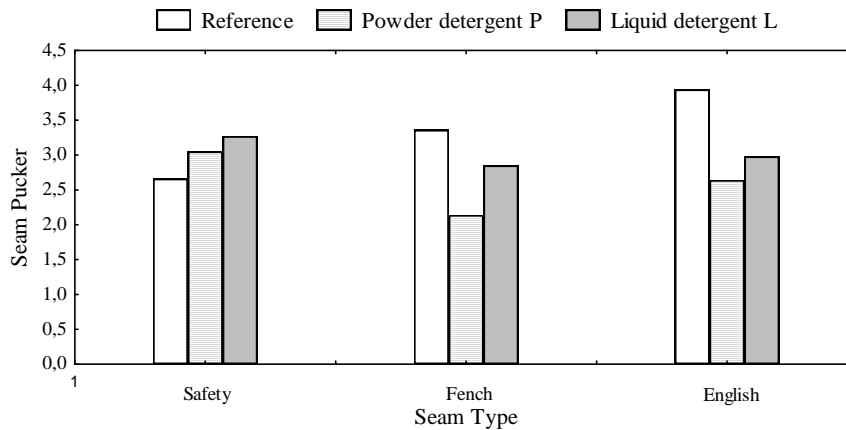

Figure 3: Average values of seam pucker of referent fabrics (R) and fabrics laundered with powder (P) and liquid (L) detergents as a function of seam type

Seam pucker may be acceptable right after the sewing, but under the impact of laundering, as the fabric shrinks, puckering, may worsen. The fabrics exhibited shrinkage after the laundering with both detergents, in warp and weft direction, ranging between 0.5-9 % and 0.5-4 %, respectively (Table 2).

Table 2: Shrinkage of shirt fabrics after laundering with powder (P) and liquid (L) detergents in warp and weft direction

No.	Shrinkage (%)			
	P		L	
	warp	weft	warp	weft
A	4	1.5	3	2
B	9	3.5	4	2.5
C	3	3	1	2.5
D	4	1.5	3	0.5
E	1	1	1	1
F	1	2	1	2.5
G	1.5	3	0.5	4
H	2	1.5	1.5	2.3
I	2	1	0	0.5
J	4	1	2.5	0
K	1.5	3	1	3

The results of evaluating the seam pucker of laundered samples with powder and liquid detergents as a function of seam types are shown in Table 1. The influence of seam type on the seam pucker of the samples laundered with a powder detergent P is shown in Figure 3. It may be noted that the safety seam led to the least seam puckering, followed by the English and French seams. Safety seam consisted one row of stitches and caused the least material distortion. French seam consists of two close rows of stitches and more layers of material into seam cross section (Figure 1). Due to its geometry, French seam was more prone to puckering. English seam also had more rows of stitches, two parallel in the first stage and additional one in the second stage. Less puckering of the English seam compared to French seam, can be attributed to longer distance between the first two rows of stitches in seam cross section. The influence of seam type on seam puckering for the samples laundered with liquid detergents L is shown in Figure 3. The safety seam shows the least seam puckering, followed by the English and French seams.

This trend could be also being observed on the samples subjected to the laundering with the powder detergent P. The influence of the laundering process and seam type on seam pucker is shown in Figure 3. The seam pucker of the samples washed with a powder detergent P followed the same evolving trend as that for the samples laundered with a liquid detergent L. The laundering with both detergents affected the seam pucker grade for the English and French seams, while the safety seam was not affected. However, analyzing the influence of the detergent and seam type on seam pucker (Figure 3), a significant difference in seam pucker can be observed. Higher seam puckering was observed when laundering with a powder detergent P, compared to the liquid one.

## CONCLUSION

The present study revealed that the seam puckering of cotton shirt fabrics were affected by laundering, because of shrinkage and by detergent type. Seam type had a significant influence on seam pucker both before and after the laundering. The safety seam demonstrated the least seam puckering after the laundering, followed by the English and French seams. The reference samples exhibited the opposite trend.

## REFERENCES

- Bishop D. P. (1995). Physical and Chemical Effects of Domestic Laundering Processes. In *Chemistry of the Textile Industry*. Edited by C. M. Carr. Glasgow, UK, Springer.
- Mori M., Niwa M., Kawabata S. (1997). Effect of Thread Tension on Seam Pucker, *Seni I Gakkaishi*, 3 (6), 217-225.
- Fan J., Leeuwner W. (1998). The Performance of Sewing Threads with Respect to Seam Appearance, *Journal of Textile Institute*, 89 (1), 142-154.
- Kung J.T., Kim C. S., Sul H. I., Youn R. J., Chung K. (2005). Fabric Surface Roughness Evaluation Using Wavelet-Fractal Method Part I: Wrinkle, Smoothness and Seam Pucker, *Textile Research Journal*, 75 (11), 751-760.
- AATCC 88B (2006). Smoothness of Seams in Fabrics after Repeated Home Laundering, *American Association of Textile Chemists and Colorists*, North Carolina, USA.
- Dobilaite V., Juciene M. (2006). The Influence of Mechanical Properties of Sewing Threads on Seam Pucker, *International Journal of Clothing Science and Technology*, 18 (5), 335-345.
- Rudolf A., Grešak J., Ujhelyiova A., Sfiligoj-Smole M. (2007). Study of PES Sewing Thread Properties, *Fibres and Polymers*, 8 (2), 212-217.
- Fathy Sayed Ebrahim F. (2012). The Impact of Sewing Thread Properties on Seam Pucker, *Journal of Basic and Applied Scientific Research*, 2 (6), 5773-5780.
- Rudolf A., Grešak J. (2012). The Effect of Drawing on PET Filament Sewing Thread Performance Properties, *Textile Research Journal*, 82 (2), 148-160.
- Choudhary A. K., Goel A. (2013). Effect of Some Fabric and Sewing Conditions on Apparel Seam Characteristics, *Journal of Textiles*, 2013, 1-7.
- Dobilaite V., Juceine M., Mackevičiene E. (2013). The influence of Technology Parameters on Quality of Fabric Assemble, *Materials Science (Medžiagotyra)*, 19 (4), 428-432.



## ALKALI SENSITIVITY OF OXY-CELLULOSES

Emilija Toshikj\*, Igor Jordanov

Ss. Cyril and Methodius University, Faculty of Technology and Metallurgy, Ruger Boskovic 16, Skopje, Macedonia  
e-mail: tosic\_emilija@tmf.ukim.edu.mk

### ABSTRACT

*Alkali sensitivity of aldehyde and carboxyl enriched oxy-celluloses obtained by oxidation of cotton was examined. The oxidation was evaluated by assessing the amount of introduced aldehyde and carboxyl groups while alkali sensitivity through the oxy-celluloses solubility in sodium hydroxide solution. The type and oxidation level of oxy-celluloses influenced their alkaline sensitivity. Aldehyde oxy-cellulose has lower alkaline stability and is more sensitive to alkaline solutions than carboxyl ones. Alkali sensitivity of oxy-cellulose determined through alkali solubility is very good method for fast determination of the performance of cellulose goods, especially valuable in assessing wearing performance of long lasting textile materials that have to withstand many washing cycles.*

**Key words:** alkali sensitivity, oxidation, carboxyl groups, aldehyde groups, cotton.

### INTRODUCTION

Future trends of textile industry include using materials from natural fibers (usually cellulosic) with integrated multifunctional properties, produced by modification of the fibers and additional treatments with chemicals, such as polymers, metals, dyes, protein, collagen, etc. (Kanth S. V. et al., 2009; Zemljčić-Fras L. et al., 2009; Kramar A. et al., 2014). Oxidation as a common path for cellulose modification is usually performed to produce oxidized cellulose with aldehyde- and carboxyl-enriched groups (Saito T. et al., 2004; Diankova M. S. V. et al., 2009; Tang L. et al., 2017; Toshikj E. t al., 2017). The type of oxy-cellulose used and the level of oxidation are influenced by its end use and usually vary between 3 % and 25 % (Ashton H. W. et al., 1968; Kumar V., 2003). Although very promising, the main disadvantage of oxy-cellulose is its alkali sensitivity, which is especially important for long lasting materials because they have to withstand many washing cycles (detergent usually has strong alkaline pH) without damaging and changing its basic properties.

The goal of this research was to examine alkali sensitivity of aldehyde and carboxyl oxy-celluloses. The aldehyde oxy-cellulose was obtained by K-periodate oxidation of cotton, while carboxyl ones by additional treatment of aldehyde oxy-cellulose with sodium chlorite. The oxidation was evaluated by determination the amount of introduced aldehyde and carboxyl groups while alkali sensitivity through the oxy-celluloses solubility in sodium hydroxide solution.

### EXPERIMENTAL PART

#### Materials

Piled, ring-worsted 100 % cotton yarns with 30x2 tex linear density and 330 twists/m were used in this study.

## Pre-treatments of cotton yarns

Oxidation was done on alkaline scoured and bleached cotton yarns. Scouring was done in a bath with 30:1 liquor ratio (LR) using 20 g/dm<sup>3</sup> NaOH in the presence of 2 cm<sup>3</sup>/dm<sup>3</sup> Cotoblanc HTD-N and 1 cm<sup>3</sup>/dm<sup>3</sup> Kemonecer NI at 95 °C for 90 min. Bleaching was done in a bath with 30:1 LR, using 6 cm<sup>3</sup>/dm<sup>3</sup> H<sub>2</sub>O<sub>2</sub> (30 %), 1 cm<sup>3</sup>/dm<sup>3</sup> Kemonecer NI, 2 cm<sup>3</sup>/dm<sup>3</sup> Na<sub>2</sub>SiO<sub>3</sub> at pH 11.2 at 95 C for 30 min. Both processes were carried out in a Linitest apparatus.

Aldehyde oxy-cellulose was obtained by oxidation of cotton yarns using 0.05, 0.1, 0.2, 0.4 and 1 g KIO<sub>4</sub>/g cellulose at pH 4, 50:1 LR at 60 °C for 30 min.

The carboxyl oxy-cellulose was obtained by additional treatment of aldehyde oxy-cellulose with NaClO<sub>2</sub> (conversion of aldehyde to carboxyl groups) in a bath with 50:1 LR, using 0.905 g NaClO<sub>2</sub>/g cellulose in 1 M CH<sub>3</sub>COOH, at room temperature for 12h (Saito T. et al., 2004).

## Testing methods

Determination of carboxyl groups by conductometric titration was performed as described in the literature methodology (Saito T. et al., 2004). The carboxyl groups were calculated from the titration curve.

Determination of aldehyde groups by the difference between the initial content and that after conversion to carboxyl groups by NaClO<sub>2</sub>. The oxidized samples were further oxidized with NaClO<sub>2</sub> for selective conversion of the aldehyde groups to carboxyl ones, and the amount of carboxyl groups was determined by the conductometric titration (Saito T. et al., 2004).

Alkali solubility of oxy-celluloses was determined according to TAPPI T212 om-02 standard. The presented results are the mean value of 3 measurements at a confidence level of 95 %.

## RESULTS AND DISCUSSION

The amount of aldehyde and carboxyl groups on oxy-celluloses related to concentration of K-periodate is shown in Figure 1. The introduced groups increase with increasing the concentration of the oxidant, so the amount varies between 50 and almost 1400 mmol of groups per kilogram of cellulose. The results show that all carboxyl oxy-celluloses have slightly higher amount of carboxyl groups than aldehyde groups in aldehyde oxy-cellulose.

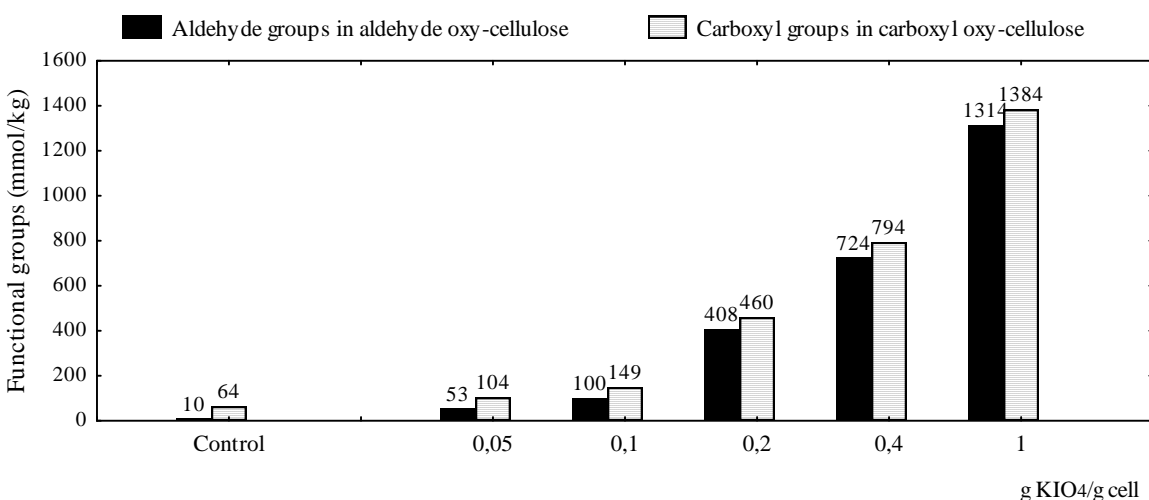

Figure 1: Aldehyde groups in aldehyde oxy-cellulose and carboxyl groups in carboxyl oxy-cellulose

The presence of aldehyde and carboxyl groups of oxy-celluloses, followed with FTIR-ATR spectra, is shown in Figure 2. The typical band of aldehyde groups appears at 1733 cm<sup>-1</sup> (Zhang L. et al., 2017). Aldehyde oxy-celluloses show similar FTIR-ATR spectra with those of the un-oxidized ones. Treatment with sodium chlorite of aldehyde oxy-cellulose strongly increased absorbance at 1738 cm<sup>-1</sup> (Figure 2) which correspond to carboxyl groups in their acidic form (Calvani P. et al., 2006), and confirm that aldehyde groups were converted to carboxyl by sodium chlorite treatment.

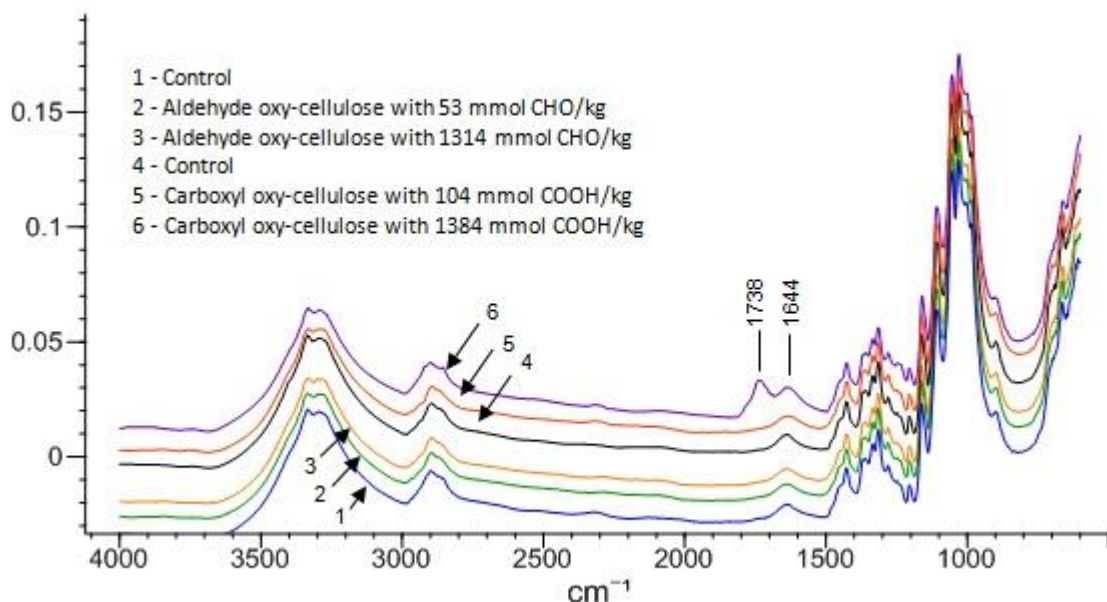

Figure 2: FTIR-ATR spectra of control, aldehyde and carboxyl oxy-celluloses

Introduced aldehyde and carboxyl groups during oxidation have influence on the degree of polymerization of oxy-celluloses. Both, aldehyde and carboxyl oxy-celluloses have lower DP than the control sample (Table 1). DP decrease as concentration of the oxidant increase. Comparing aldehyde with carboxyl oxy-celluloses, they have similar values of the degree of polymerization.

Table 1: Degree of polymerization of aldehyde and carboxyl oxy-celluloses

Treatment	Time (min)	Concentration (g KIO <sub>4</sub> /g cell)	DP	
			Aldehyde oxy-cellulose	Carboxyl oxy-cellulose
Control			1733.8	1382.7
KIO <sub>4</sub>	30	0.05	384.3	368.9
		0.1	256.7	245.5
		0.2	211.7	164.4
		0.4	72.3	129.1
		1	36.3	103.2

Alkali sensitivity is determined through alkali solubility of oxy-celluloses in sodium hydroxide solution (weight loss after treatment). The results of alkali solubility are shown in Figure 3. The results show that aldehyde oxy-celluloses are more sensitive to alkali as the amount of aldehyde group increase, confirmed through higher weight loss after treatment in sodium hydroxide solution. The alkali solubility lies in the range of 1.8 % to 27 %.

Carboxyl oxy-celluloses have lower sensitivity than aldehyde because they show lower weight loss after treatment in sodium hydroxide solution (Figure 3).

Carboxyl oxy-celluloses with low level of oxidation (oxidized with 0.05, 0.1 and 0.2 g KIO<sub>4</sub>/g cellulose) have about 4 times lower alkali sensitivity. On the other hand, carboxyl oxy-cellulose oxidized with 1 g KIO<sub>4</sub>/g cellulose have about 2 time lower alkali sensitivity than aldehyde oxy-cellulose.

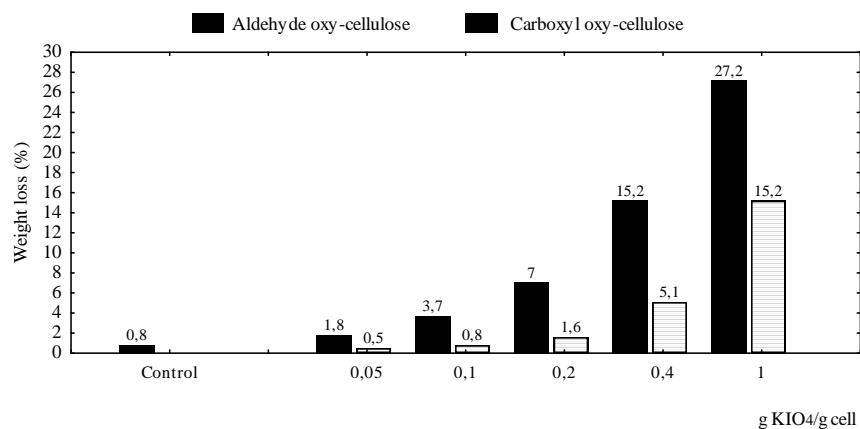

Figure 3: Alkali sensitivity of aldehyde and carboxyl oxy-celluloses determined through alkali solubility in sodium hydroxide solution

## CONCLUSION

Oxidation of the cellulose is common path for producing multifunctional textile materials with added value. The aldehyde and carboxyl oxy-celluloses with different amount of introduced groups were tested in this paper. Both oxy-celluloses have decreased DP as the concentration of the oxidant increase. Although aldehyde and carboxyl oxy-celluloses have similar values of DP, carboxyl oxy-celluloses have lower alkaline sensitivity than aldehyde and have lower solubility in sodium hydroxide solution. Therefore carboxyl oxy-cellulose is more prominent for producing long-lasting materials than aldehyde oxy-cellulose, because they will withstand more washing cycles.

## REFERENCES

- Ashton H. W., Moser E. C. (1968). Oxidized Cellulose Product and Method for Preparing the Same. United States Patent No. US3364200A.
- Kumar V.. (2003). Powdered Oxidized Cellulose. United States Patent No. US6627749B1.
- Saito T., Isogai A. (2004). TEMPO-mediated Oxidation of Native Cellulose. The Effect of Oxidation Conditions on Chemical and Crystal Structures of the Water-Insoluble Fraction. *Biomacromolecules*, 5 (5), 1983-1989.
- Calvani P., Gorassini A., Luciano G., Franceschi E. (2006). FTIR and WAXS Analysis of Periodate Oxycellulose: Evidence for a Cluster Mechanism of Oxidation, *Vibrational Spectroscopy*, 40 (2), 177-183.
- Diankova M. S. V., Doneva D. M. (2009). Analysis of Oxycellulose Obtained by Partial Oxidation with Different Reagents, *Bulgarian Chemical Communications*, 41 (4), 391-396.
- Kanth S. V., Ramaraj A., Rao R. J., Nair B. U. (2009). Stabilization of Type I Collagen using Dialdehyde Cellulose, *Process Biochemistry*, 44 (8), 869-874.
- Zemljić-Fras L., Strnad S., Šauperl O., Kleinschek-Stana K. (2009). Characterization of Amino Groups for Cotton Fibers Coated with Chitosan, *Textile Research Journal*, 79 (3), 219-226.
- Kramar A., Milanović J., Korica M., Nikolić T., Asanović K., Kostić M. (2014). Influence of Structure Changes Induced by Oxidation and Addition of Silver Ions on Electrical Properties of Cotton Yarn, *Cellulose Chemistry and Technology*, 48 (3-4), 189-197.
- Tang Z., Lin X., Hiao H., Miao Q., Huang L, Chen L., Wu H. (2017). TEMPO-oxidation Cellulose with High Degree of Oxidation, *Polymers*, 9 (9), 421-430.
- Toshikj E., Jordanov I., Dimova V., Mangovska B. (2017). Influence of Various Pre-treatment Processes on Selective Oxidation of Cotton Yarns, *AATCC Journal of Research*, 4 (4), 22-28.
- Zhang L., Ge H., Hu M., Cao J., Dai Y. (2017). Physicochemical Properties, Antioxidant and Antibacterial Activity of Dialdehyde Microcrystalline Cellulose, *Cellulose*, 24 (5), 2287-2298.

## RICE HUSK AS BIO-ADSORBENT FOR DIRECT DYES REMOVAL FROM AQUEOUS SOLUTION: EQUILIBRIUM STUDY

Nina Mladenovic, Emilija Toshikj, Igor Jordanov\*, Vesna Dimova, Dejan Dimitrovski  
Faculty of technology and metallurgy, University Ss. Cyril and Methodius  
Rudjer Boskovic 16, 1000 Skopje, Republic of Macedonia  
jordanov@tmf.ukim.edu.mk

### ABSTRACT

*Rice husk as low cost agriculture waste in Republic of Macedonia and efficient bio-adsorbent was employed as viable material for treatment of Direct Congo Red (S.I. 20120) containing industrial wastewater. The results obtained from the batch experiments revealed that ability of Direct Congo Red removal is strongly dependent of the dye concentration and the time of adsorption, so maximum dye removal was observed after 2 hours. Equilibrium of adsorption was investigated using Langmuir model, which has a strong correlation coefficient of 0.96. The maximum adsorption capacity was ~0.088 gram of dye per gram of dry rice husk. This study showed that the rice husk could be easily employed as low-cost and effective sorbent for direct dyes removal from aqueous solution.*

**Key words:** Adsorption, Rice Husk, Direct Congo Red, Equilibrium, Adsorption capacity

### INTRODUCTION

Discharge colored effluents into the ecosystem is a dramatic source of pollution in aquatic life because some azo dyes and aromatic amines, as their degradation products, are highly carcinogenic (Mohamed M.M., 2004). Thus, proper treatment of the dye plant effluent is a matter of concern before discharging. This led to an intensive search for the best available technology/technique, which can be used for removal and remediation of the dyes from the effluents making the treatment of industrial effluent important target for environment protection. Different treatment methods are described in the literature, including filtration, flocculation, chemical precipitation, ion exchange, membrane separation and adsorption (Teixeira Tarley C.R. and Zezzi Arruda M.A., 2003). The adsorption process is one of the efficient methods for contaminant removals from effluent (Nigarn P. et al., 1996; Imagawa A. et al., 2000; Mohan D. et al., 2001; Malik P.K., 2003) due to its sludge free clean operation and complete removal of dye even from dilute solutions. The adsorbents for the dye removal require a large accessible pore volume, high thermal and hydrothermal stability, no catalytic activity, and easy regeneration. New approaches based on the use of natural, renewable and inexpensive sorbents for effluent treatment have been reported (Marshall W.E. et al., 1999). The use of these materials is still limited, although they show good adsorption capacity relative to the other expensive adsorbents (Dushenkov V. et al., 1995). Activated carbon is the most widely used because it has extended surface area, microporous structure, high adsorption capacity and high degree of surface reactivity. However, commercially available activated carbons are very expensive. In addition, the laboratory preparation of activated carbons has been accompanied by a number of problems such as combustion at high temperature and pore blocking. This has led to search cheaper and simplest substituents. Rice husk, as undesirable agriculture waste, is a byproduct of the rice milling industry with about 20% of the whole rice production (Daifullah A.A.M. et al., 2003). It is cheap adsorbent with granular structure and chemical stability, and there is no need to regenerate due to their low production costs. The main composition of rice husk is 32.24% cellulose, 21.34% hemicellulose, 21.44% lignin, 1.82% extractives, 8.11% water and 15.05% mineral ash, mainly composed of 94.5 - 96.34% SiO<sub>2</sub> (Nakbanpote W. et al., 2000).

In the present study, the adsorption capacity and the equilibrium of dye adsorption of the rice husk to adsorb Direct Congo red dye (C.I.20120) from aqueous solution was explored. The Langmuir model was used to fit the equilibrium isotherm. The batch contact time method was used to evaluate the adsorption capacity and percentage of dye removal.

## MATERIALS AND METHODS

### Preparation of Sorbents

Rice husk was obtained from rice mill located in Kochani, Republic of Macedonia. It was washed several times with water followed by filtration. The cleaned rice husk was dried at ambient temperature and sieved to 1.25 - 3.0 mm size.

### Preparation of Dye Solution

Direct Congo red dye (C.I. 20120) with structure given in Figure 1 was purchased from Sinochem Hebei Company and used without further purification. A stock solution of the dye was prepared as 1 g/L solution by dissolving 1 gram of dye in 1000 mL DI water. The experimental solutions were prepared by diluting defined volume of the stock solution to get the desired concentration.

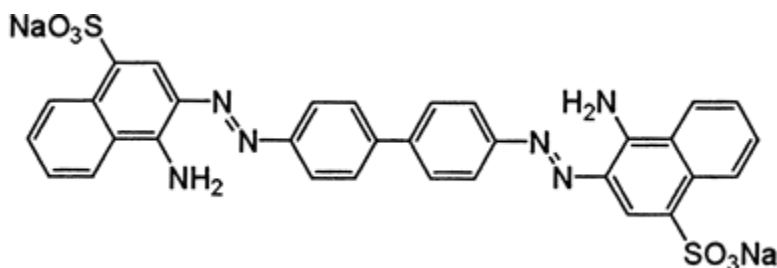

Figure 1: Structure of Direct Congo red

### Adsorption Studies

Sorption (removal efficiency) was examined using batch method in conical flasks of 500 mL which were agitated by linear shaker at constant agitation. All experiments were carried out in duplicate and the relative deviation was less than 5%.

Experiments were carried out by agitation 200 mL of dye solution with known initial dye concentration with 2 g of rice husks at room temperature (26 °C). Samples of dye solution were pipetted at different time interval and the concentration in the supernatant solution was analyzed using UV-VIS spectrophotometer (Milton Roy, Spectronic 21D) at maximum wavelength for Congo red at 507 nm. The sorption dependence of contact time or removal efficiency of rice husk was calculated using the equation:

$$\text{Removal efficiency} = \left[ \frac{(C_0 - C_t)}{C_0} \right] * 100 (\%)$$

where  $C_0$  is the initial concentration of the dye (g/L) and  $C_t$  is the concentration of the dye after adsorption at any time (g/L).

Equilibrium experiments were carried out by contacting 2 g rice husk with 200 mL of dye solution with different initial dye concentration of 0.1, 0.2, 0.3, 0.4 and 0.5 g/L. The agitation was made for 24 h.

The amount of dye adsorbed onto the rice husk  $Q_e$  (g/g) was calculated according to the mass balance equation:

$$Q_e = \frac{(C_0 - C_e) * V}{W}$$

where  $C_0$  and  $C_e$  are the initial and equilibrium concentrations of dye in g/L of dye, respectively,  $V$  is the volume of the solution (L), and  $W$  is the weight (g) of the adsorbent used.

## RESULTS AND DISCUSSION

Rice husks were used as a natural bio-sorbent for removal direct Congo red from effluent from textile industry. The results of the dye removal as a function of contact time using dye solutions with different initial concentrations are given in Figure 2. The obtained sorption (removal) curves are single, smooth and continuously lead the saturation of the rice husks. The amount of adsorbed dye (presented as gram dye per gram rice husk) increases with rising the contact time and remains constant after achieving sorption equilibrium. The curves show rapid removal rate in the initial phase and slow rate after 60 min when attained a more or less constant with no significant increase in color removal. 120 min was chosen as time to attain equilibrium.

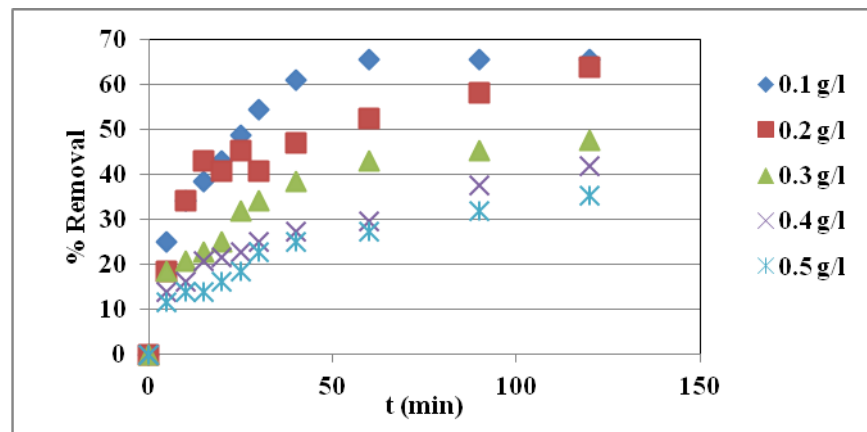

Figure 2: Influence of contact time and initial dye concentration on removal of Congo red using 10 g/L rice husk.

Equilibrium data were analyzed using Langmuir and Freundlich isotherm expressions given in the equations below and the isotherms were shown in Figure 3.

Langmuir non-linear isotherm:

$$Q_e = \frac{Q_m K_L C_e}{1 + K_L C_e}$$

Langmuir linear isotherm:

$$\frac{C_e}{Q_e} = \frac{C_e}{Q_m} + \frac{1}{K_L Q_m}$$

Non-linear Freundlich:

$$Q_e = K_F C_e^{1/n_F}$$

Linear Freundlich:

$$\ln(Q_e) = \ln(K_F) + \frac{1}{n_F} \ln(C_e)$$

where  $C_e$  is dye concentration at equilibrium (g/L);  $Q_e$  is equilibrium adsorption capacity (g/g);  $K_L$  is Langmuir adsorption constant (L/g);  $Q_m$  is maximum adsorption capacity (g/g);  $K_F$  is Freundlich constant (L/g);  $n_F$  is heterogeneity factor of adsorption sites (dimensionless).

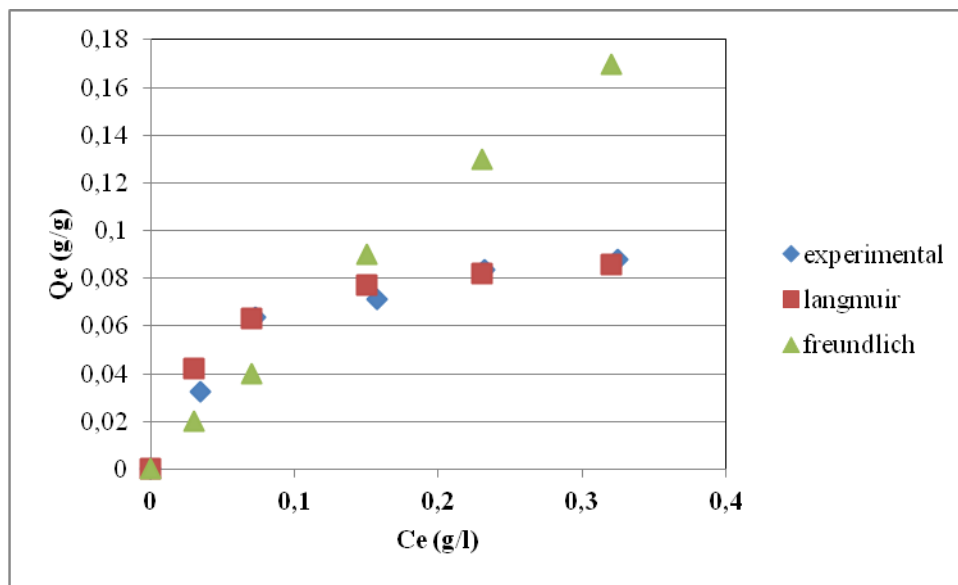

Figure 3: Adsorption isotherms of Congo red on rice husk

Calculated coefficients of correlation and other parameters obtained from the adsorption isotherms given in Figure 3 are summarized in Table 1. The fitting of the adsorption isotherms were done using values of the coefficients of correlation of experimental and theoretical data. Generally higher correlation coefficients ( $r^2$ ) of linear plots of different models show better fitting of the chosen adsorption isotherm (Malik P.K., 2003; Namasivayam C. and Kavitha D., 2003). Values of  $r^2$  of a linear plot of the Langmuir model were found to be better than Freundlich model for all dye concentrations.

The results in Table 1 show the adsorption capacity of rice husks is 0.088 g dye per gram of rice husk.

Table 1: Correlation coefficients and constant parameters calculated for various adsorption models for direct dye

Isotherms	Parameters		
	$K_L$ (L/g)	$Q_m$ (g/g)	$r^2$
Langmuir	28.45	0.09	0.968
Freundlich	$K_F$ (L/g)	$n_F$	$r^2$
	2.11	1.13	0.785



## CONCLUSION

Rice husk as natural bio-sorbent from agricultural waste is demonstrated as effective in removal direct Congo red dye from the aqueous solution. The kinetic of sorption and equilibrium adsorption results have shown exceptional ability of husk for direct dye removal in the first hour of contact time. The adsorption isotherm fits better Langmuir than Freundlich model. Maximum adsorption capacity of 88 mg of dye per gram of husk is one of the better results we met in literature (Sawasdee S. et al., 2017; Abdelwahab O. et al., 2005).

## REFERENCES

- Abdelwahab O., El Nemr A., El Sikaily A., Khaled A. (2005) Use of rice husk for adsorption of direct dyes from aqueous solution: a case study of Direct F. Scarlet, *Egyptian Journal of Aquatic Research*, 31 (1), 1-11.
- Daifullah, A.A.M., Girgis B.S., Gad H.M.H. (2003). Utilization of agro-residues (rice husk) in small waste water treatment plans, *Material letters*, 57 (11), 1723-1731.
- Dushenkov V., Kumar P.B.A.N., Motto H., Raskin I. (1995). Rhizo filtration: the use of plants to remove heavy metals from aqueous streams, *Environmental Science and Technology*, 29 (5), 1239-1245.
- Imagawa, A., Seto R., Nagaosa Y. (2000). Adsorption of chlorinated hydrocarbons from air and aqueous solutions by carbonized rice husk, *Carbon*, 38 (4), 628-630.
- Malik, P.K. (2003). Use of activated carbons prepared from sawdust and rice-husk for adsorption of acid dyes: a case study of Acid Yellow 36, *Dyes and Pigments*, 56 (3), 239-249.
- Marshall W.E., Wartelle L.H., Boler D.E., Johns M.M., Toles C.A. (1999). Enhanced metal adsorption by soybean hull modified with citric acid, *Bioresource Technology*, 69 (3), 263-268.
- Mohamed, M.M. (2004). Acid dye removal: Comparison of surfactant-modified mesoporous FSM-16 with activated carbon derived from rice husk, *J. Colloid and Interface Science*, 272 (1), 28-34.
- Mohan D., Singh K.P., Sinha S., Gosh D. (2001). Removal of pyridine from aqueous solution using low cost activated carbons derived from agricultural waste materials, *Carbon*, 42 (12-13), 2409-2421.
- Nakbanpote, W., Thiravetyan P., Kalambaheti C. (2000). Preconcentration of gold by rice husk ash, *Minerals Engineering*, 13 (4), 391-400.
- Namasivayam C., Kavitha D. (2003). Adsorptive removal of 2-chlorophenol by low-cost coir pith carbon, *J. Hazardous Materials*, 98 (1-3), 257-275.
- Nigam, P., Banat I.M., Singh D., Marchant R. (1996). Microbial process for decolourisation of textile effluents containing azo, diazo and reactive dyes, *Process Biochemistry*, 31 (5), 435-42.
- Sawasdee S., Jankerd H., Watcharabundit P. (2017). Adsorption of dyestuff in household-scale dyeing onto rice husk, *Energy Procedia*, 138, 1159-1164.
- Teixeira Tarley C.R., Zezzi Arruda M.A. (2004). Biosorption of heavy metals using rice milling by-products. Characterisation and application for removal of metals from aqueous effluents, *Chemosphere*, 54 (7), 987-995.

## INFLUENCE OF ANTHROPOMETRIC MEASUREMENTS ON THE SYSTEM SIZE OF BRAS

Blaženka Brlobašić Šajatović, Ksenija Doležal, Renata Hrženjak, Darko Ujević  
Faculty of Textile Technology University of Zagreb

### Abstract

*The clothing size system is based on anthropometric measurements. The goal of each size determination system is to select a size group to provide ready-made garments that fit individuals. The paper presents the results of body measurements important for the determination of anthropometric measurements of bras in the framework of the Croatian anthropometric system.*

**Keywords:** anthropometry, size system for bras

### 1. UVOD

Developed countries improve their standards on average every 15 to 20 years. By systematic anthropometric measurement and statistical processing of these measurements are determined: clothing and footwear systems, standard and proportional measures, and share of individual sizes for clothing and footwear. Clothing and footwear marking systems prescribe the size of clothing and footwear and determine how they are labeled. It is in the interest of consumers and manufacturers to manufacture clothing and footwear according to certain standards and to the fullest extent, and this is to satisfy the wishes of unknown customers, and this is the aspiration of every manufacturer, especially in the clothing and footwear industry. The standard or main body measurements are: body height, waist circumference, waist circumference, waist circumference and neck circumference. Proportional (auxiliary) measures are important for garment designers, because they use, with the help of the main measures, to construct garment items. Based on proportional measures, certain legalities (proportion of proportional and principal measure), ie terms used to calculate proportional measures from the main ones, are established. By means of these expressions one can determine deviations of some body from the average body figure[1].

The traditional bra pattern-making method employed by the intimate apparel industry requires lengthy and expensive pre-production schedules. The average time spent on bra pattern development can be anything from 2 to 6 months [2].

Kristina Shin et al. 2009. in their article proposes a robust algorithm for three-dimensional (3D) surface reconstruction of a bra fitted to an underlying mannequin via scanned polylines and a novel approach for bra pattern flattening based on linear least squares optimisation. This pattern flattening method projects a patch from the current viewing direction to a two-dimensional (2D) plane, with an orientation into 3D space by mesh reconstruction. The intersection of polylines is checked and a patch adjacency graph is built to form a closed patch surface, which is fitted to a mannequin. The conformity between the 3D bra patch and the 2D projection shows shape preservation when the 3D bra is flattened to 2D patterns using the proposed method. The preservations of shape entities include boundary coordinate preservation, mean value coordinate preservation, edge length preservation and adjacent surface flattening. An algorithm for calculating the local projection plane, which is used for the calculation of best fit mean value coordinate for local surface flattening is provided, figure 1 [3].

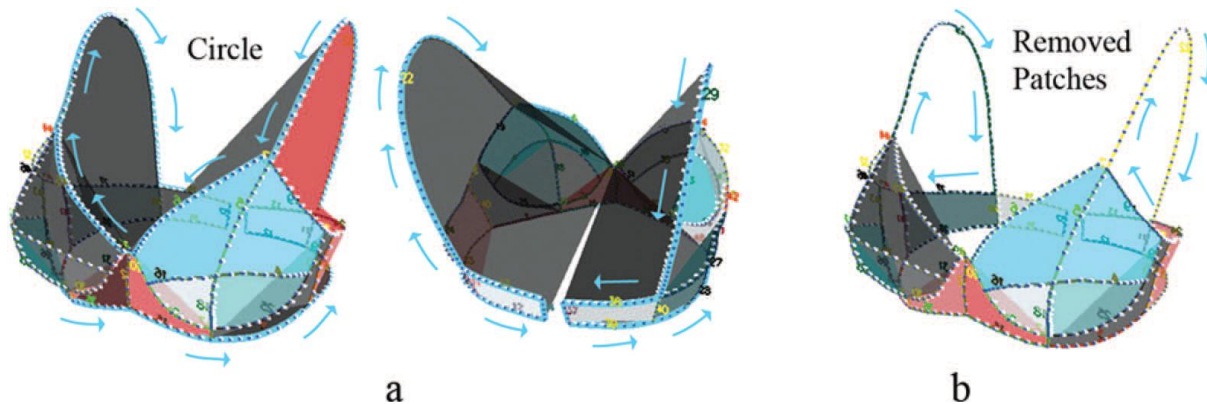

Figure 1. A closed 3D bra surface formed by patches with hole patches [3].

## 2. DETERMINING THE SIZE OF CLOTHING

By updating ISO 3635 and ISO 8559 and ISO 9407, the foundations are based on a unique definition of human body measures for the clothing and footwear industries, and thus the method of carrying out anthropometric measurements and the size marking system. Most of these systems are based on the type of figure determined by the body height and the values of the difference between the waist circumference, the bust circumference and the hip circumference. Clothing sizes are generally referred to the following growth groups: low, medium and high, and are defined by three anthropometric measures: bust, waist and hip measurements.

The European Union, or its Standards Committee (CEN), is constantly working on new clothing and footwear labeling systems based on these ISO standards. So far, standards EN 13402-1, EN 13402-2, EN 13402-3 have been issued, defining primary and secondary measures, their measurement methods, and standard measures and ways of marking the size of clothing for particular types of clothing or footwear. The use of pictograms and end-of-life characteristics of the specific measures or areas covered by an individual measure, as defined by other ISO standards and the EN, leads to customers in a very clear way, marking the size of clothing. They should reasonably easily assess whether a piece of clothing is potentially acceptable to them by physical measures on the left (horizontal) or right (vertical) side of the pictogram that depicts the human figure silhouette and the measure of the measure.

### 2.1 Size designation for women's clothing

As a basic starting point for marking the size of clothing and footwear in the Republic of Croatia, the system and the marking method defined in European standards 13402-1, 13402-2, 13402-3 are used with a national addendum that would give some specifics to be shown in certain types of clothing [6]. The EN marking system for all types of clothing in women, the same for men and children, is based on displaying the range of values of some of the characteristic measures shown on the pictogram. Which control measures, ie their ranges, will be displayed on the pictogram, depends on the type of garment. There are two types of control measures that define the size of clothing: primary or basic measure and one or more secondary measures. When marking the size of clothing for women and men, the most common primary measure is the waist circumference, figure 2.

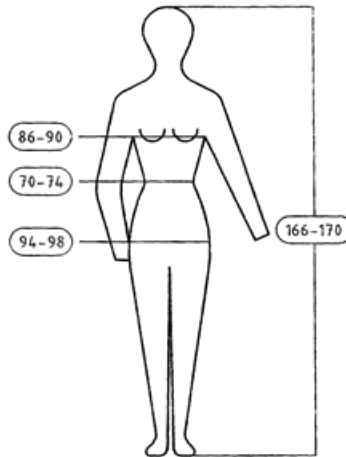

Figure 2. Pictogram

## 2.2. Bra size designation system

The basic size of the garment size for the brassiere is the bust circumference (Og) and the underbust circumference (Dog). The size of the bra size depends on the lower chest length and ranges from 75 to 110 cm. Signs (A, B, C, D, E, F) indicate breastfeeding, figure3.

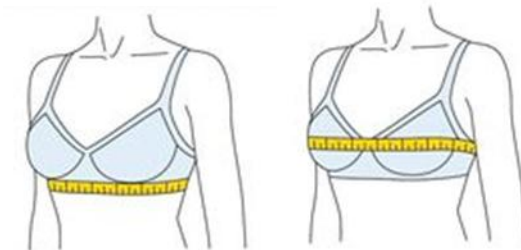

Figure 3. Measurement bust and underbust girt

The difference between the bust circumference and underbust is the size of the bracelet. In figure 4. is show the pictogram for a bra in size 70B.

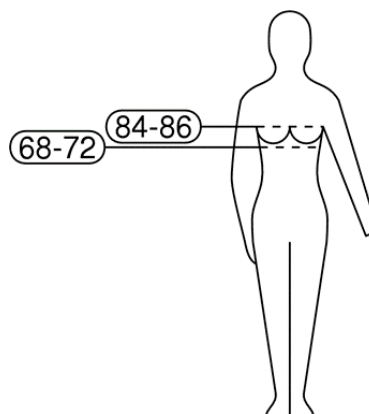

Figure 4. European Standard (EN 13402) for bra sizes with primary and secondary measurements. The pictogram shows a bra in size 70B.

Tablica 1. The difference between bust girth (Bg) and underbust girth (UbH)

<b>Bg - UbH</b>	<b>The mark of cup</b>
Od 12 - 14 cm	A
Od 14 - 16 cm	B
Od 16 - 18 cm	C
Od 18 - 20 cm	D
Od 20 - 22 cm	E
Od 22 - 24 cm	F

The bra size (also known as brassiere measurement or bust size) is the measure which indicates the size characteristics of a bra. Bra sizes are usually expressed as scales, with a number of systems being in use around the world. The scales take into account the band length and the cup size. From the wearer's point of view, the main measures that are taken into account, in determining the best bra fit for the wearer, are the measures of the wearer around the torso below the breasts and over the breasts, which defines the band length. For convenience, because of the impracticality of measuring a woman's breast size, the volume of the bra cup is based on the difference between these two measures.

Determining the correct bra size is the process manufacturers engage in to design and manufacture bras that correctly fit a majority of women, and for individual women, the process of identifying a correctly fitting bra. Bra sizes usually consist of one or more letters indicating the breast cup size and a number, indicating a band size around the woman's torso. Bra cup sizes were invented in 1932 and band sizes became popular in the 1940s.

The shape, size, position, symmetry, spacing, firmness, and amount of sagging of individual women's breasts vary considerably. Manufacturers' bra size labeling systems vary from country to country because no international standards exist. Even within a single country, one study found that the bra label size was consistently different from the measured size.[2] As a result, about 25% of women have a difficult time finding a properly fitted bra.[3] Some women choose to buy custom-made bras due to the unique shape of their breasts.

### **2.3. Manufacturer design standards**

Bra-labeling systems used around the world are at times misleading and confusing. Cup and band sizes vary around the world. In countries that have adopted the European EN 13402 dress-size standard, the torso is measured in centimetres and rounded to the nearest multiple of 5 cm. Bra-fitting experts in the United Kingdom state that many women who buy off the rack without professional assistance wear up to two sizes too small.

Manufacturer Fruit of the Loom attempted to solve the problem of finding a well-fitting bra for asymmetrical breasts by introducing Pick Your Perfect Bra, which allow women to choose a bra with two different cup sizes, although it is only available in A through D cup sizes, table 2.

Table 2. Approximate (band) size equivalents between various systems

<b>Approximate (band) size equivalents between various systems</b>																	
<b>Under bust (cm)</b>	58 - 62	63 - 67	68 - 72	73 - 77	78 - 82	83 - 87	88 - 92	93 - 97	98 - 102	103 - 107	108 - 112	113 - 117	118 - 122	123 - 127	128 - 132	133 - 137	138 - 142
<b>Under bust (in)</b>	24 - 25	26 - 27	28 - 29	30 - 31	32 - 33	34 - 35	36 - 37	38 - 39	40 - 41	42- 43	44- 45	46- 47	48- 49	50- 51	52- 53	54- 55	56- 57
<b>EU</b>	60	65	70	75	80	85	90	95	100	105	110	115	120	125	130	135	140
<b>FR, BE, ES</b>	75	80	85	90	95	100	105	110	115	120	125	130	135	140	145	150	155
<b>IT</b>	0	1	2	3	4	5	6	7	8	9	10	11	12	13	14	15	16
<b>US, UK</b>	28	30	32	34	36	38	40	42	44	46	48	50	52	54	56	58	60
<b>AU, NZ</b>	6	8	10	12	14	16	18	20	22	24	26	28	30	32	34	36	38
<b>UK dress</b>	4	6	8	10	12	14	16	18	20	22	24	26	28	30	32	34	36

One very prominent discrepancy between the sizing systems is the fact that the US and UK band sizes, based on inches, does not correspond to it's centimeter based EU counterpart. E.g. 30in equals 76cm which would suggest that US and UK band size 30 is equivalent EU band size 75. However, this is not correct. Instead, US and UK band size 30 corresponds to EU band size 65. This discrepancy stems from the fact that US and UK band sizes were originally based on above bust and under armpit measurement while EU band sizes are based on under bust measurement. This causes confusion and is what led to the Underbust +4 measuring metho

There are several sizing systems in different countries.

Cup size is determined by one of two methods: in the US and UK, increasing cup size every inch method; and in all other systems by increasing cup size for every two centimeters. Since one inch equals 2.54 centimeters, there is considerable discrepancy between the systems, which becomes more exaggerated as cup sizes increase. Many bras are only available in 36 sizes.

### 3. Results of investigation of Croatia anthropometric system for bust and underbust girth

Table 3. Standard designations of the sizes of bras, corsetry and swim-suits with cups

<b>Under bust girth</b>	60	65	70	75	80	85	90
<b>Range UbH</b>	58 - 62	63 - 67	68 - 72	73 - 77	78 - 82	83 - 87	88 - 92
<b>Cup</b>	<b>Bust girth</b>						
AA	70 - 72	75 - 77	80 - 82	85 - 87	90 - 92	95 - 97	100 - 102
A	72 - 74	77 - 79	82 - 84	87 - 89	92 - 94	97 - 99	102 - 104
B	74 - 76	79 - 81	84 - 86	89 - 91	94 - 96	99 - 101	104 - 106
C	76 - 78	81 - 83	86 - 88	91 - 93	96 - 98	101 - 103	106 - 108
D	78 - 80	83 - 85	88 - 90	93 - 95	98 - 100	103 - 105	108 - 110
E	80 - 82	85 - 87	90 - 92	95 - 97	100 - 102	105 - 107	110 - 112
F	82 - 84	87 - 89	92 - 94	97 - 99	102 - 104	107 - 109	112 - 114
G	84 - 86	89 - 91	94 - 96	99 - 101	104 - 106	109 - 111	114 - 116
H	86 - 88	91 - 93	96 - 98	101 - 103	106 - 108	111 - 113	116 - 118

Table 4. Standard designation of the bra cups

<b>Size of cup</b>	<b>Bg - Ubg</b>
AA	10 cm - 12 cm
A	12 cm - 14 cm
B	14 cm - 16 cm
C	16 cm - 18 cm
D	18 cm - 20 cm
E	20 cm - 22 cm
F	22 cm - 24 cm
G	24 cm - 26 cm
H	26 cm - 28 cm

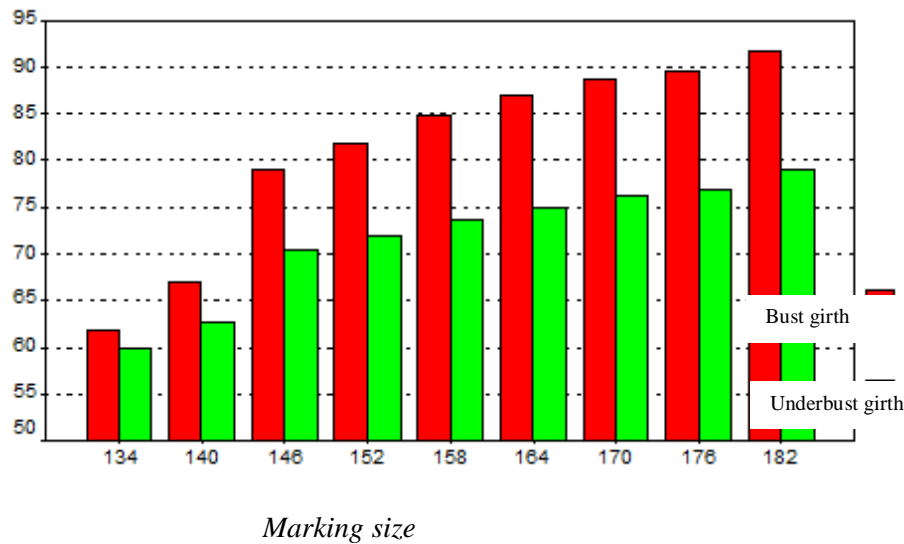

Figure. 5. Differences between bust and underbust girth for women in Croatia [7]

## 4. Conclusion

Developed countries improve their standards on average every 15 to 20 years. By systematic anthropometric measurement and statistical processing of these measurements are determined: clothing and footwear systems, standard and proportional measures, and share of individual sizes for clothing and footwear. It is in the interest of consumers and manufacturers to manufacture clothing and footwear according to certain standards and to the fullest extent, and this is to satisfy the wishes of unknown customers, and this is the aspiration of every manufacturer, especially in the clothing. The basic size of the garment size for the brassiere is the bust circumference (Og) and the underbust circumference (Dog). In this paper we present the results of investigation bust and underbust girth of women in Croatia. This result has influence on construction of bra and on clothing size system for bra.

## 5. References

- [1] Ujević D et al: Theoretical aspects and application of Croatian anthropometric system. Zagreb: University of Zagreb Faculty of Textile Technology, 2010.
- [2] Hardaker, C.H.M. and Fozzard, G.J.W., 1997. The bra design process: a study of professional practice. International Journal of Clothing Science and Technology, 9 (4), 311–325
- [3] Kristina Shin et al. (2010) A geometrically based flattening method for three-dimensional to two-dimensional bra pattern conversion, International Journal of Fashion Design, Technology and Education, 3:1, 3-14, DOI: 10.1080/17543260903460200
- [4] <https://commons.wikimedia.org/wiki/File:EN-13402-bra.png>
- [5] <https://www.queensfair.com>
- [6] HRN EN 13402 (Parts 1-3):2008, Size designation of clothes – Part 1: terms, definitions and body measurement procedure (ISO 3635:1981, MOD; EN 13402-1:2001), Part 2: primary and secondary dimensions (EN 13402-2:2002), Part 3: measurements and intervals (EN 13402-3:2004)
- [7] Croatian Technical Report (HRI 1148:2012) - Anthropometric System - Measuring and Size Designation of Clothes and Footwear, Croatian Standards Institute



## MODELING AND MECHANICS OF CROSS-KNITTED KNITWEAR

Vojislav Gligorijevic<sup>1</sup>, Goran Demboski<sup>2</sup>, Radica Nicic<sup>1</sup>, Jovan Stepanovic<sup>1</sup>, Nenad Cirkovic<sup>1</sup>

<sup>1</sup>University of Nis, Faculty of Technology, Leskovac, Serbia

<sup>2</sup>ss. Cyril and Methodius University in Skopje, Faculty of Technology and Metallurgy, Skopje, Macedonia

e-mail: [vojatrik@yahoo.com](mailto:vojatrik@yahoo.com)

### Abstract

*In this paper, the mechanism of deformation of the right-left knit is described with the assumption that the fingers behave like a thin elastic rod. The mechanics of thin stitching elements developed by observing the mechanical patterns of knitting behavior exerted by the external forces are discussed. For modeling, it is enough to consider a quarter of loop AC two twisted coffin. The forces and moments in point B are the result of the outer forces and the reaction force in the interwoven parts of the loop. Friction forces occur in the direction of lines and rows of loops. In vertical components the tension of the knitting appears in the direction along the lines that will require that the external forces are balanced. When the knitwear in the relaxed state of the vertical component will not be. The loop form is obtained assuming that the funnel is elastic and therefore under the force of the force and the moments will satisfy the elasticity of the equation. The forehead is treated as two separate elastic pieces, and the directions of these parts are obtained separately using the elasticity model. A particularly flexible elasticity model for thin-layered filaments and its application in knit loop mechanics have been described.*

Key words: loop, loop length loop, loop geometry, geometric loop model, modeling, elasticity, force and moments, tension twists.

### 1. Knitting Mechanics: 2D Model

In this part, the mechanism of deformation of ordinary knitting is described, assuming that yarns behave like a thin elastic rod or elastic. The first structure of knit loop, unit of knitwear, is explained. The thin expandable filament mechanics are subject to great deformation developed by observing the mechanical patterns of knitting behavior exposed to external forces. The model is a part of Shanahan and Postle's work while the computer aspects are borrowed from the approach of Konopasek and Hearle as far as elasticity is concerned. The following list (Table 1) provides variable and their meanings for a 2D mechanical model.

Table 1. Nomenclature

Changing	Description
x,y,z	Global coordinates.
v,w	Local coordinates .
S	enght length measured along the central elastic line with deformation / yarn .
S <sub>0</sub>	Lenght length measured along the central elastic line without deformation / yarn .
ε	Straining .
W <sub>x</sub>	The cosine cosine of the local coordinates, w, with the x-axis .
W <sub>y</sub>	The direction cosines of the local coordinates, w, given the y-axis .
M	Moment of small elastic element / yarn .
F <sub>v</sub>	The internal force of the component is normal on the central elastic line / yarn. .
F <sub>w</sub>	Inner force components, tangential to the central elastic line / yarn.
p	Curvature of the central elastic line / yarn .
U <sub>b</sub>	Bending energy.
E	Tensile elastic module / yarn.
E <sub>b</sub>	Elastic bending / yarn module.
A	Cross section elastic band / yarn.
D	Elastic thickness / yarn .
β	Safety Corner.

### 1.1. Structure of knit loops

The loop has symmetry of mirrors around the vertical line passing through the point D in Figure 1.

Further consideration of the semi-loop ACD shows that the wrong AC can transform into the wrong CF over 180 ° rotation around the point C. Therefore, for the purpose of modeling enough to consider quarter of the loop, AC. Figure 1 shows two interlaced curls (half loop). The curves of a row are along the horizontal x-or, and the y-section defines the direction of the loop sequences. The receipt is taken at item B.

The forces and moments in point B are the result of the external forces and the force of the reaction due to the overlapping of the knit loops and these can be the friction forces in the direction of the lines and ranks. One important characteristic is the reaction force of the force at the point in the point B ,. If there is a vertical component, the tension of the knitting would be in the line along the lines that would require the external forces to be balanced. Such vertical components would therefore be absent in relaxed knitwear or when outer forces applied in the order of rows. Hence, in other cases, the reaction is effective in B fluid with a horizontal x-or / line of lines.

In the picture. 2, F and F<sub>v</sub> are, in turn, the inner forces of the components together and governed at the center tangent (central line). The equilibrium of the force-moment of the diagram equilibrium, with the forces and moments acting on B, is shown in Figure 2.

The extra moment  $M = F_w * d / 2$  for the diameter of the diameter  $d$  gives the cause for the initial curve differences at point B for elastic BA and BC. Next, as far as the BC path of curvature is concerned at C, or curvature  $p = 0$  in C, and x-coordinates in C is  $d / 2 * \cos\beta$ . Corner  $\beta$  is a blocked angle.

The last two boundary conditions are needed to find a solution for a relaxed and tight knitwear. In the case of an external force acting in the direction of strings or absence of external forces, the shape of the segment BA is a circular arc.

The shape of the loop is obtained on the assumption that the yarn is elastic and therefore under the force of the force and the moments will satisfy the elasticity of the equation. The device is treated as two separate elastic pieces, BA and BC, and the paths of these parts are obtained separately using the elasticity model. The elastic BA is usually not the same as in the continuous B for the elastic BC, ie the curve is not continuous on B. The following section describes the elasticity model for expandable thin filaments and its application in the knit loop mechanics.

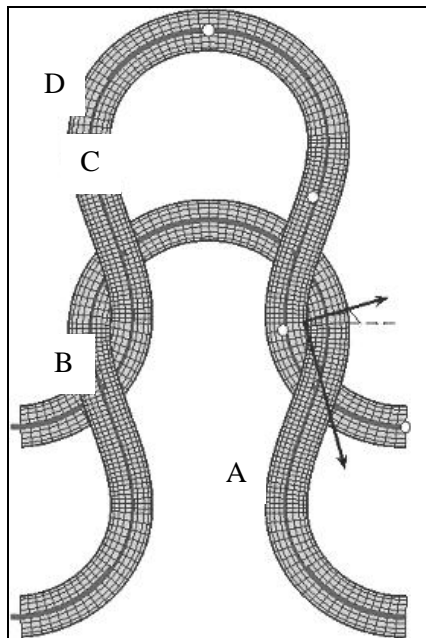

Figure 1. Two connected halves (half loop)

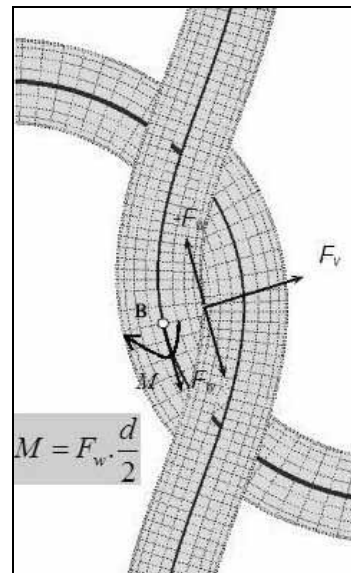

Figure 2. Equivalent force diagram

## 1.2. Planar non-expandable elasticity-control equations

Equations for unbreakable elasticity are derived in terms of differential equations of the first order, as well as others more susceptible to the integration of the numerical method. Figure 3 shows a small element (unfinished loop)  $ds$  in a loop with internal forces and balanced moments

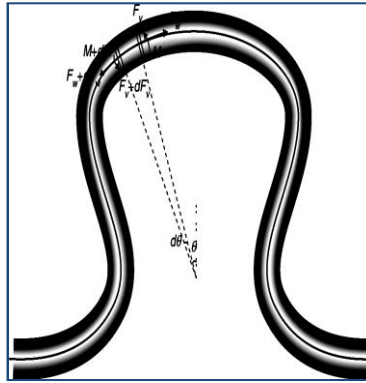

Figure 3. Small element (lock) knit loop

From differential equations:

$$\frac{dx}{dt} = \cos\theta = w_x, \quad (1)$$

$$\frac{dy}{dt} = \sin\theta = w_y, \quad (2)$$

$$\frac{dw_x}{ds} = -\sin\theta \frac{d\theta}{ds} = p \cdot w_y, \quad (3)$$

$$\frac{dw_y}{ds} = \cos\theta \cdot \frac{d\theta}{ds} = pw, \quad (4)$$

Taking moments around the center of the element in the picture. 3 we get:

$$\frac{dM}{dt} = F_v \quad (5)$$

Since  $M = Eb \cdot p$ , where  $Eb$  is the bending stiffness, equation 5 may be written as follows:

$$\frac{dp}{ds} = \frac{F_v}{E_b} \quad (6)$$

Thanks to the balance of force on the element in Figure 3, it gives:

$$F_v = (F_v + dF_v) \cdot \cos(d\theta) - (F_w + dF_w) \cdot \sin(d\theta) \quad (7)$$

$\cos(d\theta) \approx 1, \sin(d\theta) \approx d\theta$  and ignoring second order conditions:

$$\Rightarrow \frac{dF_v}{ds} = p \cdot F_w \quad (8)$$

$$F_w = (F_w + dF_w) \cdot \cos(d\theta) + (F_v + dF_v) \cdot \sin(d\theta) \quad (9)$$

$$\Rightarrow \frac{dF_w}{ds} = -p \cdot F_v \quad (10)$$

The final bending of energy,  $U_b$ , was given as follows:

$$\frac{dU_b}{ds} = \frac{1}{2} \cdot E_b \cdot p^2 \quad (11)$$

### 3. Load-deformation behavior of plain knit knitwear

The load increase is applied to the knitting in regular small steps, along the rows or in the lines of the lines, and the deformation of the simulated model is divided into two phases. The first stage does not have skid at the contact points.

In the second phase the slip occurs when the tangential force at the contact point exceeds the force of friction. Each of the estimated steps of assumption of curvature, load, mutual angle, or arc length is mandatory. The values given in the previous steps give an estimate. For the first load step, the calculation procedure assumes estimates for curvature, load, pitch, or arc length are described in the appendix. Point B in the picture. 3 is taken as the original.

The load increase is applied to the knitting in regular small steps, along the rows or in the lines of the lines, and the deformation of the simulated model is divided into two phases. The first stage does not have skid at the contact points.

In the second phase the slip occurs when the tangential force at the contact point exceeds the force of friction. Each of the estimated steps of assumption of curvature, load, mutual angle, or arc length is mandatory. The values given in the previous steps give an estimate. For the first load step, the calculation procedure assumes estimates for curvature, load, pitch, or arc length are described in the appendix. Point B in the picture. 3 is taken as the original.

### 4. Deformation of loop sequences

#### Without sliding the loop

The unknown initial values are the curvature  $P_c(0)$  of the elasticity BC in Figure 3, the load response FX in B and the safety angle  $\beta$ . For simulation, the load process assumes the estimates used for these parameters and is still using the Newton-Raphson iterative process to improve the estimation in a certain accuracy.

#### With sliding loop

Sliding occurs when the friction forces are exceeded at the contact points. The slider is  $\tan(\beta) \geq$  friction coefficient. At the sliding phase, the safety angle remains unchanged and is equal to the start of the sliding. The length LBC and LAB in the image. 3 changes mainly due to loop deformation For modeling the loop mechanics by deformation with the slip of the yarn, the unknown changes that we have to estimate before using the elastic model are: curvature  $P_c(0)$ , external FX force acting on B delta loop BC and length  $L_{BC}$ .

### 5. Load-deformation behavior of plain knit knitwear

The load increase is applied to the knitting in regular small steps, along the rows or in the lines of the sequences, and the deformation of the simulated. The pattern is divided into two phases.

The first stage has no slip on the contact points. In the second stage the slip occurs when the tangential force at the contact point exceeds the force of friction. Each of the estimated steps of assumption of curvature, load, mutual angle, or arc length are mandatory.

The values given in the previous steps give an estimate. For the first load step, the calculation procedure assumes estimates for curvature, load, pitch, or arc length are described in the appendix. Point B in Figure 3 is taken as the original.

Initial values for loop segment BA

$$x=y= 0.0 \tag{12}$$

$$w_y = -\cos\beta \tag{13}$$

$$w_x = \sin\beta \tag{14}$$

$$p_A(0) = p_C(0) + (F_{nizova} - F_x) \cdot \frac{d}{2 \cdot E_b} \cdot \sin\beta \tag{15}$$

$F_{of\ strings}$  is the external force applied in the sequence of strings that coincides with the x-axis.

$$F_v = -F_{nizova} \cdot w_y \tag{16}$$

$$F_w = -F_{nizova} \cdot w_x \tag{17}$$

Initial value for segment loop BC

$$x = y = 0.0 \tag{18}$$

$$w_y = \cos\beta \tag{19}$$

$$w_x = -\sin\beta \tag{20}$$

$$F_v = -(F_x - F_{nizova})w_y \tag{21}$$

$$F_w = (F_x - F_{nizova})w_x \tag{22}$$

## CONCLUSION

The forces and moments in point B are the result of the external force and the reaction force to overcome the loop. These may be the friction forces in the direction of the sequences and reed loops. One of the important characteristics is the reaction force reaction force at the point at point B. If the vertical component component of the tension knit would was in the chain of loops that would require that the outer forces to balance. In the relaxed state of the knitting this component does not exist, or if the outer forces are applied in the direction of the rows of loops.

Looping occurs when the friction forces are too high at the contact points. The slider is  $\tan(\beta) \geq$  coefficient of friction. For the modeling of the loop mechanics by sliding deformation, the unknown variables we have to evaluate before using the elastic model are: curvature  $P_c(0)$ , external  $F_x$  force acting on B delta loop BC and LBC length.

## A RESEARCH OF THERMAL PROPERTIES OF DYED 1x1 RIB KNITTED FABRIC

**Slaviša Djurdjević, Marija Pešić, Vasilije Petrović, Danka Joksimović, Anita Milosavljević**  
 Singidunum Sverige AB - Konultverksamhet inom textil och kläder, Tröllhättanstad, Sverige,  
 Technical faculty " Mihajlo Pupin", Zrenjanin, University of Novi Sad

### Abstract

*In this paper it is presented the impact of the yarn countsl of the 1: 1 RIB cotton, dyed knitted material on the thermal resistance and on coefficient heat retention ability. Knitwear that are used for examination are commercially used for the production of clothes of next-to -skin-wear. The eight samples of RIB knitted material were analyzed, and they are made from 100% cotton yarn with different linear densities and with 96% cotton yarn and 4% of Lycra (44dtex). Used cotton yarn for samples are with linear denisty of 20, 17, 15 and 13 tex. From the obtained results we can see that the higher ability for heat retention have knitwear with Cotton/Lycra composition with linear density of cotton yar 20tex*

**Key words:** thermal resistance. comfort, rib knitwear,

Clothing comfort is an important factor in the stage where people make their clothing selections[1]. The comfort is considered as a result of balanced process of heat exchange between the human body, clothing and environment. The garments can be seen as a heat exchange layer between the body and its environment, and contemporary requirements regarding clothing comfort are much higher than in the past. Comfort is also an important factor in business garments, since they are intended to be worn trough out the whole day in different environmental conditions[2].

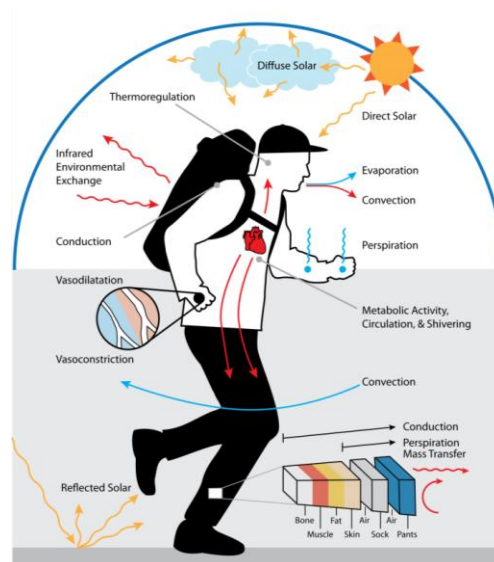

Figure 1. Thermoregulation of human body.

The center of the body warmth control is located in the brain and regulates warmth transport by blood flow through blood vessels, capillaries to the skin surface and sweat secretion. To control heat exchange , it is possible to protect the body against overheating as well as against under cooling. In this case physical regulation controls heat loss, and chemical regulation controls thermal processes.

Body is heated by thermal energy which is produced from the energy generated due to the decomposition of energy - rich carbohydrate molecules and fats. Heat transfer can occur by radiation R, convection C, conduction K, evaporation E and respiration  $E_{res}$  [4]. Figure 1 shows thermoregulation of human body [5].

The main aim of this paper is to compare coefficient of heat retention ability and thermal resistance of knitwear made from cotton/lycra. All the samples are made from different yarn counts with RIB structure. Thus, this could allow the manufacturers to manufacture cost-efficient knitwear with optimum properties. In this way the consumers would have the opportunity to buy products with required properties, for a better price.

## MATERIAL AND METHODS

Experimental part of this paper was carried out using the knitwear that are commercially used for the production of clothes of next-to-skin-wear. This kind of clothes are worn either as one-layer summer wear or as the first layer that is in contact with human skin in cooler season of the year. The knitwear samples are produced with 1x1 RIB structure. Samples are made of 100% CO yarns and CO yarns in combination with Lycra (96% CO / 4 % LY). Linear density of Lycra which was used is 44dtex. CO yarn was used in four linear densities : 20, 17, 15 and 13 tex. Samples were in dyed state. The characteristic of the knitwear samples are shown in the table 1.

Knitwear are made on a circular knitting machine type Fv 2.0 of company Mayer & Cie. Characteristics of the machine are as follows: cylinder diameter 19 "(inch), the gauge is E18 and with 40 feeders, the knitting speed is 1.7 m / s. All of the samples are knitted under the same conditions on the same machine.

*Table 1. Basic characteristics of analyzed knitwear's samples*

Samples	CP1	CP2	CP3	CP4	CL1	CL2	CL3	CL4
Structure	1x1RI B	1x1RI B	1x1 RIB	1x1RIB	1x1 RIB	1x1 RIB	1x1 RIB	1x1 RIB
Fiber composition	100% CO	100% CO	100% CO	100% CO	96% CO / 4% LY	96% CO / 4% LY	96% CO / 4% LY	96% CO / 4% LY
Linear density (tex/dtex)	20	17	15	13	19/44	17/44	15/44	13/44
Twists (m-1)	565	627	655	693	565/ -	627/ -	655/-	693/-
Mass per unit area (g m <sup>-2</sup> )	216.39	180.08	154.93	127.95	290.48	250.48	223.62	187.28
Finishing	dyed	dyed	dyed	dyed	dyed	dyed	dyed	dyed

All fabric samples were conditioned by being kept under the atmosphere conditions ( $20 \pm 2^\circ\text{C}$  temperature and %  $65 \pm$  relative humidity) for at least 24 hours before the experimental studies.

The KES FB 7 - Thermo Labo II measuring device was used to test the thermal characteristics of knitted samples.

Determination of coefficient of heat retention ability  $\alpha$  is performed in the wind tunnel of the Thermo Labo II device. In order to start measuring, the first BT plate should be heated to  $35^\circ\text{C}$  and then measured heat loss and heat flow.



A constant flow of air at a temperature of  $1\text{ms}^{-1}$  at a constant temperature of  $20\text{ }^{\circ}\text{C} \pm 2\text{ }^{\circ}\text{C}$  is present in the wind tunnel. Constant air flow is achieved by switching on the fan.

Since the knitted fabric tested in this paper is in direct contact with the human body, a dry contact method and a wet contact method were used to determine the loss of heat flow.

From the obtained values of the loss of heat flow, the heat retention ability for dry and wet methods is determined, which is expressed through the heat retention coefficient  $\alpha$ , according to the expressions:

$$W = \frac{\bar{W}}{(BT - T_a)} \cdot 100 \left( W/m^2\text{ }^{\circ}\text{C} \right)$$

$$\alpha = \frac{\bar{W}_0 - \bar{W}}{\bar{W}_0} \cdot 100(\%)$$

where is :

$\bar{W}$  - the value of the loss of heat flow with the sample at a standard temperature ( $20^{\circ}\text{C}$ ) and relative humidity of the air (65%) [ $W$ ],  $\bar{W}_0$  - vloss of heat flow without sample at standard temperature ( $20^{\circ}\text{C}$ ) and relative humidity of the air (65%) [ $W$ ], BT - temperature of BT plate [ $^{\circ}\text{C}$ ],  $T_a$  - temperature of the environment [ $^{\circ}\text{C}$ ] [6].

Thermal resistance (Rct) represents thermal insulation of the material and it is inversely proportional to the thermal conductivity, which is shown by the formula [6].

$$Rct = \frac{h}{\lambda} \left( \frac{m^2 K}{W} \right)$$

In dry materials or in materials that contain very small amounts of water, it depends directly on the thickness of the material (h) and the conductivity of fibers ( $\lambda$ )

## RESULTS AND DISCUSSION

The mean values, standard deviations and measurement units of coefficient of heat retention ability  $\alpha$  and thermal resistance Rct in the knitwear which were obtained from the standard measurements conducted on the knitwear are shown in table 2. The significance value within the study was acknowledged as (p) 0,05. If significance value (p) of parameter was greater than 0,05 ( $p > 0,005$ ), it was interpreted that the parameter did not make a statistically significant difference. One Way Analysis of Variance (ANOVA) was conducted on the independent samples in order to determine if yarn linear density and its composition of the fabrics showed statistically significant differences on the coefficient of heat control capability  $\alpha$  and thermal resistance Rct of the knitwear.

Table2 : A results of standards measurements of the knitwear samples

Sample	Coefficient of heat retention ability ( $W/m^2 \text{ } ^\circ C$ )					Thermal resistane ( $\frac{m^2 K}{W}$ )		
	Number of measure.	Mean - dry contact method	Standard deviation	Mean wet contact method	Standard deviation	Number of measure.	Mean	Standard deviation
CP1	5	14.09746	0.29361	32.1975	0.84457	5	0.07098	0.00147
CP2	5	13.61206	0.55386	34.41504	0.74905	5	0.07357	0.00338
CP3	5	13.13658	0.78495	34.94109	0.36801	5	0.07635	0.0048
CP4	5	12.73475	0.45568	34.8508	0.73015	5	0.07862	0.00282
CL1	5	15.33667	0.86261	33.11634	0.79474	5	0.06534	0.00195
CL2	5	14.49397	1.01602	32.23529	1.16358	5	0.06767	0.0012
CL3	5	13.85087	0.62786	33.1082	0.95694	5	0.07011	0.00259
CL4	5	12.95736	0.7512	34.0756	0.99881	5	0.07741	0.00458

There are two hypotheses of ANOVA analysis that are conducted for each property. Null Hypothesis: The means of all levels are equal. Alternative Hypothesis: The means of one or more levels are different. At the 0,05 level, the population means are significantly different.

Levene test was conducted before the ANOVA analysis. Levene test was done for variance homogeneity. It was seen that variances were homogeneous. In order to define the relationship between the fabrics, Tukey HSD multiple comparison test was conducted.

According to the results of Levene test,  $F=0.60435$  and significance level was  $p=0.74777$ . In this case it was observed that distribution variances were homogeneous. According to the ANOVA results  $F=7.59202$  and  $p=2,12562E^{-5}$ . Therefore Alternative hypothesis was accepted. That mean that there is statistically significant difference between the Coefficient of heat retention ability (dry contact method) of the knitwear values o the fabric. According to Tukey Hsd multiple comparison test we can see that there is significant difference between samples CL4 and CL2, CL4 and CL1, CL3 and CL1, CL2 and CP4, CL1 and CP4, CL1 and CP3, CL1 and CP2 another samples did not show significant difference except (figure 2)

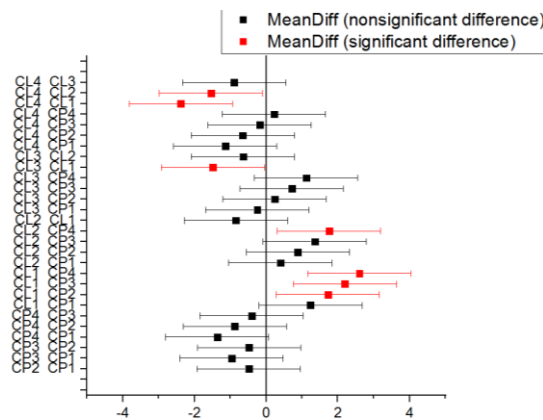

Figure2: Tukey HSD multiple comparison test for coefficient of heat retention ability obtained by dry contact method

According to the results of Levene test,  $F=0.81273$  and significance level was  $p=0,58344$ . In this case it was observed that distribution variances were homogenous. According to the ANOVA results  $F= 8,36951$  and  $p=8,5491E^{-6}$ . Therefore Alternative hypothesis was accepted. That mean that there is statistically significant difference between the coefficient of heat retention ability (wet method). According to Tukey Hsd multiple comparison test (Figure 3) we can see that there is only significant differences between samples CL4 and CL2 , CL4 and CP1, CL3and CP3, CL2 and CP4, CL2 and CP3, CL2 anc CP2, CL1and CP3, CP4 and CP1, CP3 and CP1, CP2and CP1, and another samples did not showed significant difference.

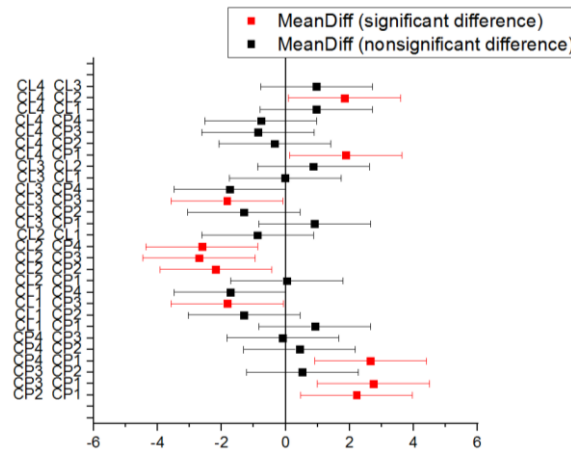

Figure 3: Tukey HSD multiple comparison test for coefficient of heat retention ability obtained by wet contact method

According to the results of Levene test,  $F=1.90476$  and significance level was  $p=0.10147$ . In this case it was observed that distribution variances were homogenous. According to the ANOVA results  $F= 11.78999$  and  $p=2.56709E^{-7}$ . Therefore Alternative hypothesis was accepted. That mean that there is statistically significant difference between the thermal resistance  $R_{ct}$  values of the fabric. According to Tukey Hsd multiple comparison test (Figure 4) we can see that there is significant differences between samples CL4 and CL3, CL4 and CL2, CL4 and CL1, CL4 and CP1, CL3 and CP4, CL2 and CP4, CL2 and CP3, CL1 and CP4, CL1 and CP3, CL1 and CP2, CP4 and CP1, , and the another did not showed significant difference.

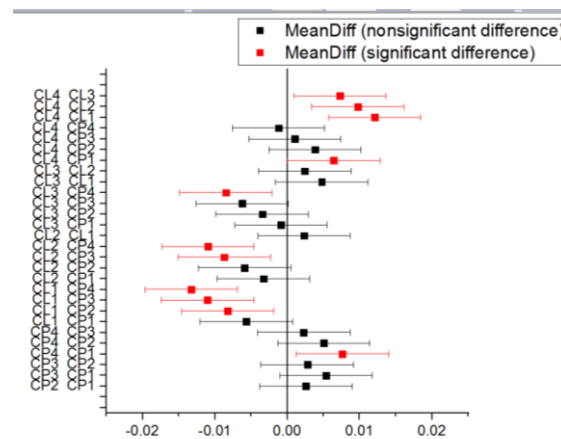

Figure4: Tukey HSD multiple comparison test for coefficient of heat retention ability obtained by thermal resistance  $R_{ct}$

## CONCLUSIONS

RIB knitwear have often been used in next to skin clothes in colder weather or like single garment in summer season. Heat and moisture transfer properties should be good so that they can have optimum properties.

From the obtained results we can see that the higher ability for heat retention have knitwear with Cotton/Lycra composition with linear density of cotton yar 20tex. The value for coefficient of heat retention ability for this sample is  $15.33667 \text{ W/m}^2 \text{ }^\circ\text{C}$  in dry conditions. This knitwear is recomanded for colder wetter conditions. This is mostly contributed by the content of the lycra, which contributes to a more compact structure of knitwear. The smallest heat retention ability in dry conditions shows knitted fabric made of 100% cotton yarn with linear density of 13tex i.e. sample CP4. In wet conditions, i.e. when sweating, the best values of heat retention coefficient show CP3 knitwear of 100% cotton and its amount is  $34.94109 \text{ W/m}^2 \text{ }^\circ\text{C}$ . The lowest values of the coefficient of heat retention capacity show knitted fabrics of 100% cotton made from the thickest yarn and its amount is  $32.1975 \text{ W/m}^2 \text{ }^\circ\text{C}$ .

The highest thermal resistance is shown by cotton knitted fabrics made from yarn with linear density of 13 tex and its value is 0,07862. The smallest value of thermal resistance we can see by knitwear made from cotton and lycra and with linear density of cotton yarn of 20 tex ( sample CL1).

- Acknowledgment: This paper is a part of the research project No. TR – 34020, financed by the Ministry of Education, Science and Technological Development of the Republic of Serbia.

## LITERATURE

- [1]B. Mijović, I. S. Čubrić, Z. Skenderi. "Measurement of thermal parameters of skin-fabric environment." 112, no. 1 (2010).
- [2]D. Celcar, J. Geršak, H. Meinander. "The influence of environmental conditions on thermo physiological wear comfort of business clothing." 5th International conference Innovation and Modelling of Clothing Engineering Processes , 2017. 141-149.
- [3]<https://www.thermoanalytics.com>.
- [4]"Operating Instruction KES-F7: Manual for KES 7 Thermo Labo II (Precise and Promt Thermal Prosperity Measurement Instrument). Kyoto : Kato Tech Co. Ltd, 1998."
- [5]Utkun, E. "A research on variuos comfort properties of interlock knitted fabrics." *Industria textila* 66, no. 1 (2015): 23-26.
- [6]Gözde ERTEKİN\*, Arzu MARMARALI – Heat, Air and Water Vapor Transfer Properties of Circular Knitted Spacer Fabrics, 2011;
- [7] Naray Ucar, Turgut Zilmaz – Thermal properties of 1x1, 2x2, 3x3 Rib Knit Fabrics – Fibers and Textiles in Eastern Europe
- [8] V. Petrović, M.Savić, D.Trajković, M. Reljić:The analysis of the knitted fabrics' characteristics substantial for the thermophysical comfort of clothes, Menadžment, Inovacije, Razvoj, Volume 5, No.16, str. 3 - 10, (2010).
- [9]S.Stojiljković, V. Petrović, J. Stepanović, M. Reljić, S.Sinđelić: Analiza uticaja tekstilnih i ostalih materijala na udobnost spavanja, međunarodni naučno-stručni skup »ENERGETSKA TEHNOLOGIJE – 2010. – sa tematskom konferencijom: MENADŽMENT, INOVACIJE, RAZVOJ«, SRBIJA SOLAR, 21 maj 2010., Vrnjačka Banja, (rad štampan u Zborniku radova u elektronskoj formi)

## ANALYSIS OF THE INFLUENCE OF THE DENSITY OF FABRICS ON ITS STRENGTH

Nenad Stojanovic, Anita Milosavljević, V. Petrović, D. Trajkovic, D. Joksimović, M. Pesic

Yumco Munchen, Germany

\*Faculty of technology Leskovac, University of Nis - The Scholarship Holder Of The Ministry  
Technical Faculty "Mihajlo Pupin", Zrenjanin,  
Đure Đakovića Bb, 23000 Zrenjanin

mail: [anita.milosavljevic@hotmail.com](mailto:anita.milosavljevic@hotmail.com)

### ABSTRACT

*The aim of the work is to examine and analyze how the density of the fabric influences its strength, and the force of the fabric during tearing and damage, to determine the greatest elongation of the fabric, but also to determine where the weakest is, as well as its minimum elongation. In order to obtain such results, different densities of rusted wires and fineness of the fabric were studied, density 10, 15 and 20 cm<sup>-1</sup>, and fines 50, 33 and 20 tex per funnel. Arikal Chiffon was selected for the test: raw material composition 100% cotton, gp 21.5 cm<sup>-1</sup>, 25.3 cm<sup>-1</sup>, weight 110 m<sup>-2</sup> to 190 m<sup>-2</sup>, stream of fineness 50 tex, base of fineness 30 tex, intertwined in canvas. For the purpose of testing this article has changed the density and fineness of the stream. In this paper, samples of different densities of rocks were tested: 10 cm<sup>-1</sup>, 15 cm<sup>-1</sup> and 20 cm<sup>-1</sup>. Also, the different finishes are as follows: 20 tex, 33 tex and 50 tex. For each density and fineness, 5 samples were prepared in the direction of the course of the dimension: 10 cm wide and 30 cm high, which were examined on the dynamometer, while the weaving of the fabric was carried out on the FIMTESSILE RP120 type.*

**Key words:** *Fabric strength, canvas interlacing, fabric density.*

### 1. INTRODUCTION

Clothes are constantly exposed to various straining, these straining depend on body movement, clothing, fabrication, but also the quality of the fabric or fabric itself. Too much straining can lead to damage to materials and clothing, different deformations, and most often this happens on the material itself. Solving this problem requires a series of research, fabric testing and data processing that needs constant work.

In order to contribute to the solution of this problem, the work suggests testing linen fabric. In order to achieve the improvement, it is first necessary to determine where and in which density and fineness the greatest force and stretching occurs, as well as where it is weakest, such as the stretching and the strength of the fabric.

Examining samples of different densities with the change and combining of different fineness of the effect, knowing that the fineness and density of the fabric contributes most to its strength, or strength at a certain stress and damage force. Fabrics are stable and compact textile materials suitable for making clothes and many other textile products for different purposes (conventional, technical and medical textiles). The longitudinal wire system is called the base, and the weft system; The upper side of the fabric is the face, and the lower side is the back. Interweaving the base with the stream is done according to established laws, which are determined by the appropriate constructive solutions of fabrics, whereby the product of the projected characteristics is obtained. The way the wire wire system is crossed with the thread wire system is called the interlacing of the fabric.

Fabrics differ in each other according to the properties, which are largely determined by their structure and the raw material composition. Fabric properties affect their reproducibility and application.

The density of the wires in the fabric means the number of wires arranged per unit of length, that is, the width of the fabric. In this case, it is usually 1 cm, so the unit of wire density is fabric in cm-1. The density of the base (dp) and weft (dw) wires is particularly expressed when densifying the wire density. According to the density of the wires the fabrics are divided into thick, medium and rare density. Dense fabrics are those in which the space between the adjacent wires is smaller than the diameter of the yarn. Medium density cloths are those in which the space between the adjacent wires is equal to the diameter of the yarn. Rare fabrics have a larger intermediate space between adjacent wires from the diameter of the yarn. The maximum wire density (gmax) indicates how much wire of the given diameter (d) can be placed one to the other on the unit of length, that is, the width of the fabric.

## 2. EXAMINATION OF MECHANICAL FEATURES OF FABRICS

The mechanical properties of the fabrics depend on the properties of the fibers and the physical and mechanical characteristics of the yarn.

Mechanical properties are determined by the action of static and dynamic forces. Experimental method, by the action of static forces, determines the values of breaking force and interrupted elongation. These values can be obtained depending on the direction of testing: for fabrics in the direction of the base and the crest.

The universal dynamometer *Tenso Lab3 2512A* - the Italian manufacturer *Mesdan* was used to measure the breaking force and intermittent elongation of the tested samples under the influence of static forces.



*Picture 1. Displays the Tenso Lab3 2512A dynamometer during sampling*

Values for intermittent force and elongation are read on the dynamometer at the moment of the tube tearing. In addition to direct reading of these characteristics, the dynamometer also has the ability to display the curve  $F-\epsilon$  in electronic form. Figure 4 shows the curves of  $F-\epsilon$  in the direction of the base and the threads in the examination of the fabric made in the linen interlace. The tissue size of the test tube is determined according to the standard SRPS F.S2.017, entitled: Physical testing of textiles - Determination of intermittent force and elongation of fabrics.

### 3. PROCEDURE FOR EXAMINATION

For the examination, the chiffon is selected: the raw material composition is 100% cotton, gp 21.5 cm<sup>-1</sup>, 25.3 cm<sup>-1</sup>, the mass is 110 m<sup>-2</sup> to 190 m<sup>-2</sup>, the weft fine fin 50, the base fins 30 tex, intertwined in canvas. For the purpose of testing this article has changed the density and fineness of the stream. In this work, samples of different densities were studied along the streams: 10 cm<sup>-1</sup>, 15 cm<sup>-1</sup> and 20 cm<sup>-1</sup>. Also, the different finishes are as follows: 20 tex, 33 tex and 50 tex. For each density and fineness, 5 samples were prepared in the direction of the course dimension: 10 cm wide and 30 cm high, which were tested on the dynamometer. The obtained results are shown in the continuation of the paper where the smallest and maximum force or the severity of tissue sampling can be seen, the strength of which is influenced by the tested fabric density.

The weaving was carried out at the type of loom FIMTESSILE RP120.



*Picture 2. The weaving on loom FIMTESSILE RP120*

### 4. REVIEW OF THE GRANTED RESULTS OF DIFFERENT WIRE DENSITY

In order to examine the effect of the density of the fabric on its strength, a comparison of the obtained results was made, since the three densities of the weft wires  $d_w$  in cm<sup>-1</sup> (10, 15 and 20) and three different fineness of the weft in tex (50, 33 and 20) were observed, In this way, the strength of the fabric was determined based on its greatest and minimum elongation. The obtained results are shown and compared to the histograms where changes in the strength of the fabrics are observed depending on the different densities and the percolation fineness. There are signs of interrupting the forces of fabrics and intermittent elongation, both on the rug and on the basic wires.

In the earlier comparisons of the obtained results, an examination and comparison of various effects on the fabric and its quality were carried out in this case was determined by the influence of exclusively different densities on the quality of the fabric.

**Comparison of the fineness 50, 33, 20 by the densities of the stranded wire 10, 15, 20**

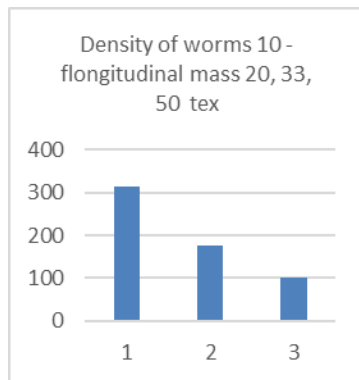

*Picture 3.*

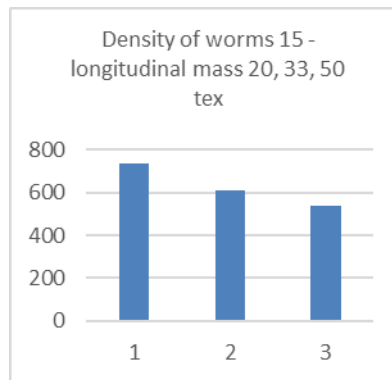

*Picture 4.*

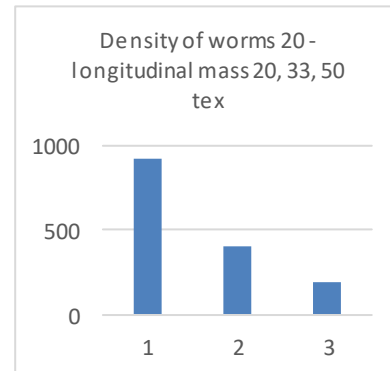

*Picture 5.*

In pictures 3, 4 and 5, each density of the stitched wires, that is, the fabric individually at which the three fins of the stitched wires have been changed, are shown. The fins 20, 33 and 50 tex have been changed in the direction of rugged wires, where we can see what happened with a fabric that was 10, 15 and 20 cm<sup>-1</sup> density, or how the force changes in the density of rusted wires.

With the density of 10cm<sup>-1</sup> of the stranded wire, according to the results, we see that the maximum tensile force of the 316N fabric, at a fineness of 50 tex in the direction of the weft wires, and at least 100 N, at a fineness of 20 tex of the weft wire.

With a density of 15 cm<sup>-1</sup> of weft wires, a comparison of the fineness showed that the maximum force for the fineness of the fabric is 50 tex and is 574N. The smallest was also shown at fin 20, it is 166.7N.

While at densities of 20 weft wires, the greatest tearing force per stream has been shown at a fineness of 50 tex and amounts to 932.2 N, while the smallest 181.2 N is at a fineness of 20 tex.

By comparing the crushing force of the tested fabrics, in all tested fines and wire density, it is seen that the largest breaking force for a fabric with a maximum density of 20cm<sup>-1</sup>, is 932.2N at a fineness of 50 tex. The minimum tensile force is at least 10 cm<sup>-1</sup> density and is 109.8N.

Such force and strength were revealed due to differences in the densities of the weft wires. Observing all the densities of rusted wires and with each fineness, we can conclude individually that in the case of fabrics with a higher density of weft wires, the volume increases, while in the case of fabrics with lower density, this strength decreases. In larger densities due to the higher number of threads of threaded wire, the harder the crack and the fabric strength is greater. Also, when the density is smaller, the number of threads in the fabric is smaller and the tensile strength is smaller.



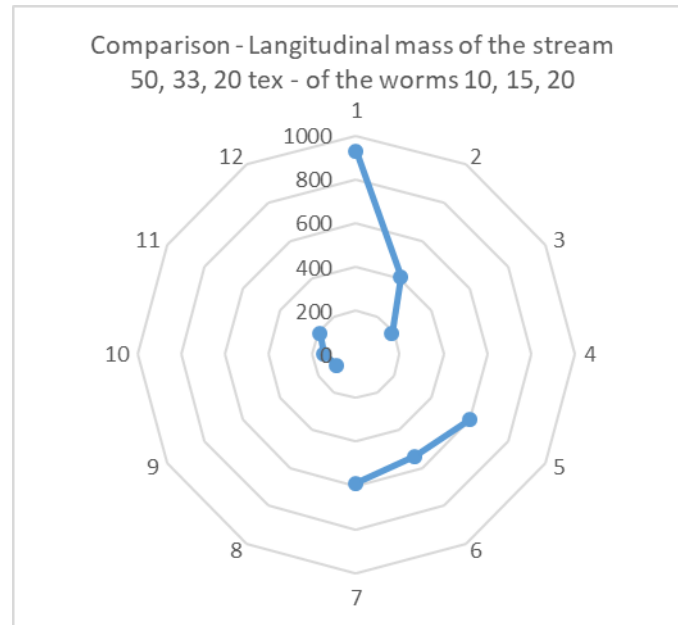

**Picture 6.** Shared display and density comparison in all examined finishes - shown in pictures 3, 4 and 5.

When the obtained values are compared, it can be concluded that the thickness of the weft wire of 20 cm-1 is the largest tissue breaking force, with a fineness of 50 tex, compared with the fins 33 and 20. In this case, the fabric is made of linen interlining, a fin of fin 20 tex, at least the density of 10cm-1 of the stinging wire, showed the smallest strength in all the examined finishes. The obtained results determined the influence of different densities, larger and smaller on the quality of the fabric, ie the strength of the fabric, which is an important indicator for its quality.

## 5. Conclusion

By testing and on the basis of the obtained results, we came to the conclusion that the density of the weft wire is 20 cm<sup>-1</sup> the most durable, at a fineness of 50tex, compared with the other finishes of 33tex and 20tex. Significant fabric strength was achieved when testing this wire density. When all the crushing forces of the fabrics that were examined were compared, the greatest force was shown for the fabric with the highest density of the rolled wires, the density of 20cm-1, and it amounted to 932.2 N, and at the same time the maximum fineness of 50. The smallest breaking force was shown at least densities of stumpy wires, density 10cm-1.

Based on all of the above, we can conclude that for the purpose of achieving the best possible strength, quality and elongation of the fabric, the density of the wires and the fineness which is combined and influences the strength of the fabric is crucial. By comparing all the densities and fineness, we see that in the case of fabrics with higher density in the direction of the weft wires, the strength increases, while in the case of fabrics with a lower density of weft wires, the strength increases, and the shear effects become weaker.

## 6. Literature

1. J.Stepanović, S. Janjić: Mechanical textile technology, University in Banja Luka, 2015.
2. Technical information of the manufacturer Mesdan, 2016.
3. D. Radivojević, M. Đorđević, D. Trajković: Textile testing, High School of Textile Textile, Leskovac, 2016.
4. Investigation of the influence of qualitative characteristics of fabrics on thermophysiological properties of clothes - doctoral dissertation – Mirjana Reljić – Leskovac 2016.
5. D. Rogale. D. Ujević, S. F. Rogale. M. Hrastinski: Processes of clothes production, Zagreb, Textile - Technology Faculty, University of Zagreb, 2011
6. V. Petrović, J.Stepanović, M.Stanković, M. Reljić, S.Stefanović: Contemporary trends in the textile and clothing industry in Europe, Management, Innovation, Development, Volume 8, No.1, str. 83 - 89, (2013). UDK005, ISSN 1452-8800.
7. A. Kunštek, B. Knez: Damage to seams on clothes, Textile - Zagreb, 35 (1986) 6, 389-402
8. U. Schmid, J. Mecheels: Kräfte an Textilien und Nähte der Kleidung in Abhängigkeit von
9. Körperbewegungen und Kleidungsschnitt, Bekleidung + Wäsche, 33 (1981) 2, 77-82
10. В. Ф. Шаньгина: Структурная схема показателей качества соединений деталей одежды, Технология легкой промышленности - Москва, 26 (1983) 2, 113-117
11. Е. Б. Коблякова: Структурная схема показателей определяющих уровень качества одежды, Швейная промышленность - Москва, (1976) 2, 10-11, (1976) 3, 21-24
12. D. Rogale. D. Ujević, S. F. Rogale. M. Hrastinski: Processes of clothes production, Zagreb, Textile - Technology Faculty, University of Zagreb, 2011.

## INFLUENCE OF THE STRUCTURE OF TEXTILE MATERIALS ON THE COMFORT OF CLOTHING

**Marija Pešić, Vasilije Petrović, Danka Joksimović, Anita Milosavljević, Stanislava Sindelić**  
Technical faculty "Mihajlo Pupin", Zrenjanin, University of Novi Sad

### Abstract

*Clothing comfort is an important factor in the stage where people make their clothing selections. Thermophysiological comfort is directly related to physiological processes of human body and is the result of the balanced process of heat exchange between the human body, the clothing system and the environment. Structural properties of the knitted fabrics are in the relations with thermal insulation, therefore this paper shows the influence of linear coefficient of fullness of loop or loop module  $\delta$  and surface coefficient of the loop  $\delta_p$  on thermal insulation. The measurements in this paper was carried out on commercially 1x1 RIB knitted fabrics used for the production of next -to-skin shirts. The one group of samples are made from 100% cotton yarn and another with 96% cotton and 4% lycra. It is noticed that knitted material structural parameters affected the change in heat resistance and thermal conductivity and they shows a high correlation values between this parameters.*

**Key words:** Thermal insulation, clothing comfort, RIB knitwear, structural parameters

### INTRODUCTION

Clothing comfort is an important factor in the stage where people make their clothing selections[1]. It is also an important factor in business garments, since they are intended to be worn trough the whole day in different environmental conditions. The garments can be seen as a heat exchange layer between the body and its environment, and contemporary requirements regarding clothing comfort are much higher than in the past. Thermophysiological comfort is directly related to physiological processes of human body and is the result of the balanced process of heat exchange between the human body, the clothing system and the environment[2].

Equation of heat balance includes three terms: those for heat generation in the body, heat transfer and heat accumulation. The degree of metabolic energy of body M produces energy, enabling the body to the mechanical work W, and the heat remainder is released as heat (i.e. M -W) To analyze heat exchange between body and environment , specific production procedures and heat exchange for the human body are used. Fanger provides the fallowing relation to meet the conductions for thermal comfort[3].

$$H - E_{dif} - E_{sw} - E_{res} - C_{res} = R + C$$

where all terms contain the unit  $W_{m^{-2}}$  and H is metabolic heat production,  $E_{dif}$  is external mechanical work or evaporation by moisture diffusion through the skin,  $E_{sw}$  is heat loss by sweat evaporation,  $E_{res}$  is heat loss by latent respiration,  $C_{res}$  is heat loss by dry respiration ove the unit area.

From externals surface of the porous material in space, heat is transferred by convection, conduction and radiation simultaneously.

Heat transfer by radiation occurs constantly between body and the environment where the body dwells, i.e. in both directions, depending on differences in body skin temperature and temperature of other surfaces. Average heat loss by radiation varies, and in moderate climatic regions it may range from 40 to 60% . Heat transfer by convection is caused by the air flow around the body or by movement of liquid drops if the body is in the water. This fact depends to a great extent on the difference in skin and air temperature, and on air (liquid) flow velocity.

Under normal conditions, about 30% of heat is exchanged by this type of heat transfer between body and environment. The heat quantity transferred by conduction is considerably lower than the quantity transferred by convection, and it becomes essential when people being in contact with cold objects and the like are in the water. Heat transfer by conduction, applies t 15% of the total heat transfer, and it depends primarily on object vision and the material that is in contact with skin. Heat transfer by sweat evaporation is always present and it increases in hot environment. If environment temperature rises over a comfortable body temperature, hot skin secretes depend on moisture quantity on the skin and the difference between water vapor pressures on the skin and in environment. In a human being, evaporation is always present. Under normal conditions it ranges from 450 to 600 ml a day, meaning that there is a heat loss between 50 and 70 kJ/h[4].

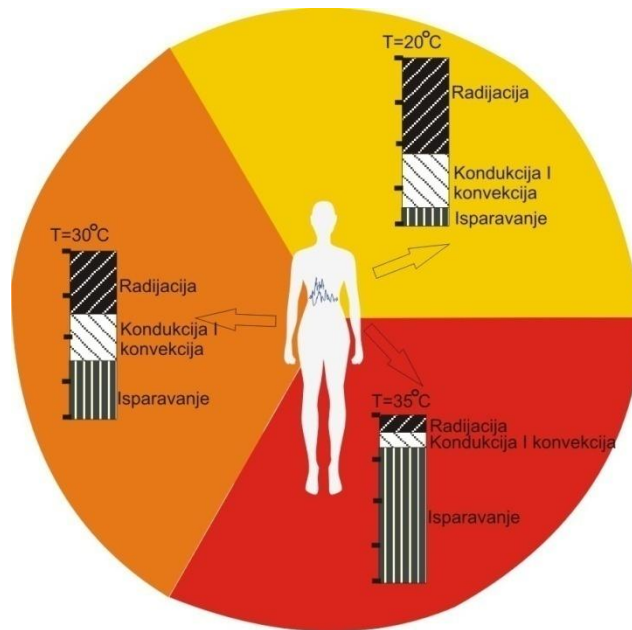

*Figure 1 : Transfer of heat between the human body and the environment in different temperature conditions[2]*

The measuring values that reflect the ability to assess the heat exchange of the human body with the environment is related of human perceptions of comfort, are thermal resistance or insulation  $R_{ct}$ . Structural properties of the knitted fabrics are in the relations with thermal insulation, therefore this paper shows the influence of linear coefficient of fullness of loop or loop module  $\delta$  and surface coefficient of the loop  $\delta_p$  on thermal insulation[5].

## **MATERIALS AND METHODES**

The investigation was carried out using the knitted fabrics that are commercially used for the production of next - to - skin - wear. This product are worn as the first layer that is in contact with human skin. The knitting structure used in this paper is 1x1 RIB produced with two different fiber composition. First type of samples are made from 100% cotton yarn, and second type of samples are made from 96% cotton and 4 % Lycra. Also, there is two types of linear density for cotton yarn. Used linear densities in this paper are 20 tex and 13 tex. Knitwear are made on a circular knitting machine type Fv 2.0 of company Mayer & Cie. Characteristics of the machine are as follows: cylinder diameter 19 "(inch), the gauge is E18 and with

40 feeders, the knitting speed is 1.7 m / s. All of the samples are knitted under the same conditions and same machine.

The illustration of RIB knitwear structure is given in figure 2. The basic characteristic of these knitwear is that both the left and right loops are visible on both sides of the knit. In these knitwear one or more wales of right loops are replaced with one or more wales of left loops[5].

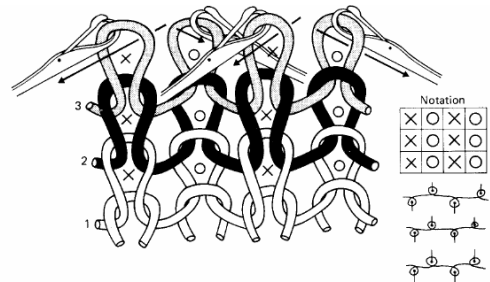

Figure 2. Face and reverse loop wales in 1x1 rib[6]

The samples were finished according to the recipe that includes optical bleaching and softening. The fabric designation and description are shown in Table 1.

Table 1. Basic characteristics of analyzed knitwear's samples

Samples	B <sub>1</sub>	B <sub>2</sub>	B <sub>3</sub>	B <sub>4</sub>
Structure	1x1RIB	1x1RIB	1x1 RIB	1x1 RIB
Fiber composition	100% CO	100% CO	96% CO / 4% LY	96% CO / 4% LY
Linear density (tex/dtex)	20	13	20/4,4	13/4,4
Twists (m-1)	565	693	565 / -	693/ -
Finishing	bleached	bleached	bleached	bleached

## RESULTS AND DISCUSSION

The KES FB 7 - Thermo Labo II measuring device was used to test the thermal characteristics of knitted samples.

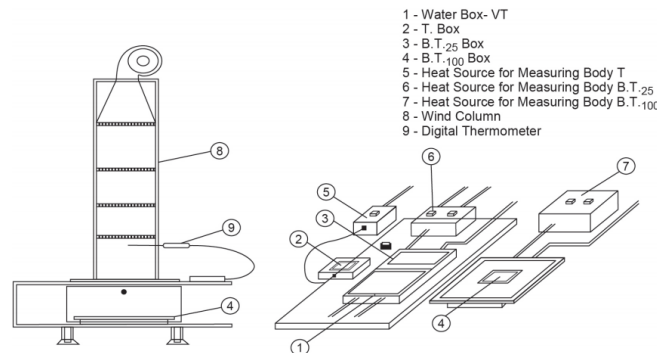

Fig.1. Kes FB 7 - Thermo Labo II device

Thermal resistance (Rct) represents thermal insulation of the material and it is inversely proportional to the thermal conductivity, which is shown by the formula[7].

$$R_{ct} = \frac{h}{\lambda} (m^2 K/W)$$

In dry materials or in materials that contain very small amounts of water, it depends directly on the thickness of the material (h) and the conductivity of fibers ( $\lambda$ )[7].

Linear coefficient of fullness of loop or loop module  $\delta$  was determined according to the following equation (5):

$$\delta = \frac{l}{d}$$

The linear coefficient of fullness affects the mechanical and physical properties of knitted fabrics such as density, elasticity, stretch ability, strength, thickness and weight of knitted fabrics.

The surface coefficient or loop module up shows the relationship between the surface occupied by one loop and the surface occupied by the thread from which the loop is made[5]

$$\delta_p = \frac{A \cdot B}{l \cdot d}$$

where is:

A - step loop, mm,

B - loop length mm,

d- thickness of the yarn, mm,

l- yarn consumption in loop, mm.

Experimentally obtained mean values of heat resistance Rct , linear coefficient of fullness, and surface coefficient are shown in Table 2

Table 2. Mean values of Rct,  $\delta$  and  $\delta_p$

sample	Rct ( $m^2 K/W$ )	$\delta$	$\delta_p$
B1	0.072503	1.603409	5.533899
B2	0.078844	1.998611	6.728191
B3	0.067672	1.622727	1.622727
B4	0.076808	2.038889	2.038889

Figures 3 and 4 show the dependence of the heat resistance (insulation) - Rct and the linear coefficient of fullness ( $\delta$ ) of bleached knitted fabrics made from 100% cotton yarn and bleached knitted fabrics made from 96% cotton and 4% of lycra.

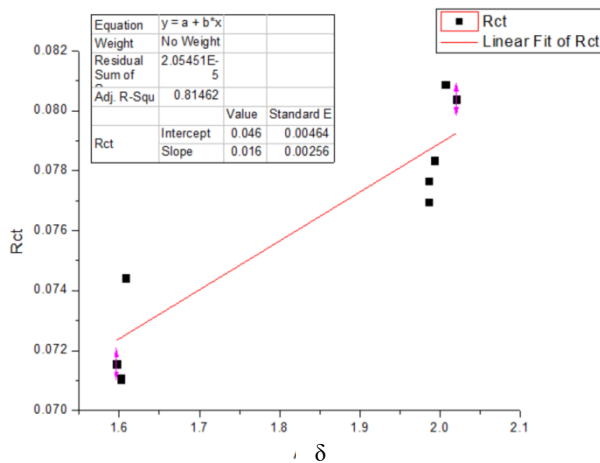

Figure 3. Thermal insulation dependence ( $R_{ct}$ ) of the linear coefficient of fullness ( $\delta$ ) of bleached 100% cotton knitwear with different linear densities of yarn

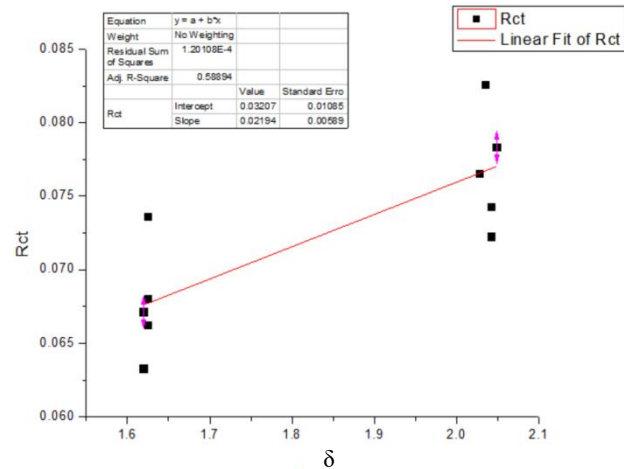

Figure 4. Thermal insulation dependence ( $R_{ct}$ ) of linear coefficient of fullness ( $\delta$ ) in bleached knitted fabric of 96% cotton 4% of lycra with different linear densities of yarn

In 100% cotton bleached ribbed knitwear with different yarn fineness, we can see that the coefficient of correlation of thermal insulation and the linear coefficient of solidity ( $\delta$ ),  $r^2$  is 0.81462, while in bleached knitted fabrics made of 96% cotton and 4% of lycra this correlation coefficient  $r^2$  is 0, 58894. The correlation coefficient values are high because these quantities are directly dependent.

Figures 5 and 6 shows the dependence of the heat resistance (insulation) -  $R_{ct}$  and the surface coefficient ( $\delta_p$ ) of bleached knitted fabrics made from 100% cotton yarn and bleached knitted fabrics made from 96% cotton and 4% of lycra.

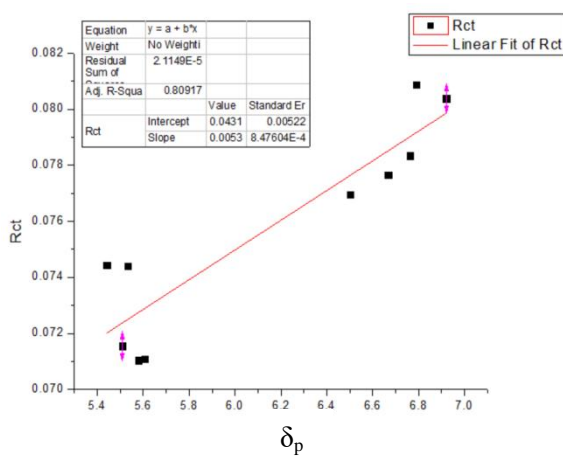

Figure 5. Dependence of thermal insulation ( $R_{ct}$ ) and surface coefficient or loop ( $\delta_p$ ) of bleached 100 % cotton knitwear with different linear densities of yarn

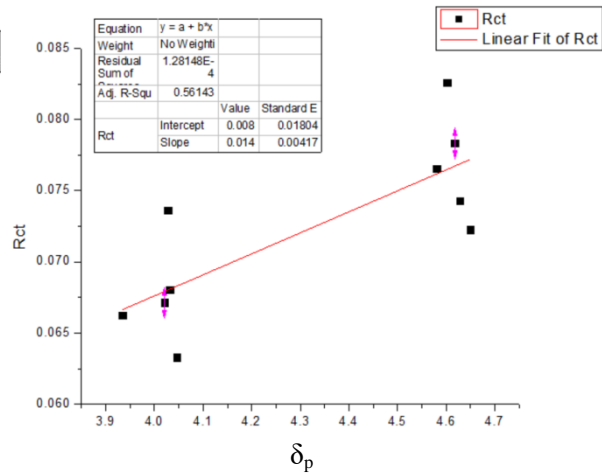

Figure 6. . Dependence of thermal insulation ( $R_{ct}$ ) and surface coefficient or loop ( $\delta_p$ ) of bleached 96 % co and 4% lycra knitwear with different linear densities of yarn

In 100% cotton bleached ribbed knitwear with different yarn fineness, we can see that the coefficient of correlation of thermal insulation and the surface coefficient of loop ( $\delta_p$ ),  $r^2$  is 0,80917, while in bleached knitted fabrics made of 96% cotton and 4% of lycra this correlation coefficient  $r^2$  is 0,56143. The correlation coefficient values are high because these quantities are directly dependent.

## CONCLUSION

Knitted fabric have a structure which offers stretch ability and elasticity of knitwear. This advantages make knitwear comfortable and fit well to body contours, providing transpiration as well. It can be concluded that structural parameters of bleached 1x1 rib knitwear are largely influenced by thermal insulation  $R_{ct}$ , which is also confirmed by high values of correlation coefficient. The greatest correlation between the thermal insulation  $R_{ct}$  and the linear coefficient of fullness can be seen with knitwear made from 100% cotton yarn, where this coefficient has a value of 0,81462. This knitwear, made from 100% cotton yarn, also shows the best correlation between  $R_{ct}$  and surface coefficient and it is 0,80917. High values, i.e. the great correlation between these structural parameters and the thermal resistance, i.e., the insulation occurs because it is largely dependent on the filling of knitted fabrics with the yarn, i.e. from the porous spots occurring in the structure of knitted fabrics inside and between the loops.

## REFERNCES

- [1] M. Pesic, V. Petrovic, J. Stepanovic, C. Besic, The analysis of dimensional stability of 1x1 rib co and co/ly knittwear, *Industria textila*, Vol. 59, No.4, 2018., ISSN 1222-5347, pages 293-297.
- [2] *Comfort - related properties of woven fabrics produced from Dri-release yarns*. E., Utkun. 5, 2014, *Industria Textila*, Vol. 65, pp. 241-246.
- [3] *Measurement of thermal parameters of skin-fabric environment*. B. Mijović, I. Salopek Čubrić, Z. Skenderi. 1, s.l. : Periodicum biologorum, 2010, Vol. 112, pp. 69-73.
- [4] *Heat transfer from humans wearing clothing* . A., Lotens W. 1993 : PhD Thesis, Deft University of Technologies.
- [5] *Measurement of thermal parameters of skin-fabric environment*. Mijović B.; Salopek Čubrić I.; Skenderi Z. 1, 2010, *Periodicum Biologorum*, Vol. 112, pp. 69-73.
- [6] Petrović, V. *Tehnologija pletenja*. Zrenjanin : Technical faculty "Mihajlo Pupin", 2000.
- [7] Lasić, V. *Vezovi i pletiva*. Zagreb : s.n., 1998.
- [8] *Operating Instruction KES-F7: Manual for KES 7 Thermo Labo II (Precise and Prompt Thermal Prosperity Measurement Instrument)*. Kyoto : Kato Tech Co. Ltd, 1998.

**Acknowledgment:** This paper is a part of the research project No. TR – 34020, financed by the Ministry of Education, Science and Technological Development of the Republic of Serbia. We thank the Ministry for financial assistance.



## METHODS OF NC GUIDANCE IN THE CASE OF AUTOMATIC MACHINES AND AGGREGATES

D. Joksimović, V. Petrović, M. Pešić, A. Milosavljević, S. Sindelić, N. Petrović

Technical Faculty "Mihajlo Pupin", Zrenjanin,

Đure Đakovića bb, 23000 Zrenjanin

email: [danka.joksimovic21@gmail.com](mailto:danka.joksimovic21@gmail.com)

### Abstract

*The aim of the work is to explain the methods of NC guidance in the case of automatic machines and aggregates, their use as modern clothing production technology which reduces the cost of direct live work on machines, and the share of itelektual - indirect live work increases (preparation time technological documentation and implementation of work orders, designing, programming, design and modeling of clothes, fitting of cut images, simulations...).*

**Keywords:** *NC guidance, aggregates, machines, machines*

### Introduction

Dressing is man's basic and lasting need. Therefore, in the future there will be a need for clothing so that the existence of a clothing industry can not be called into question. This will require constant development and acquisition of new knowledge in the field of clothing technology. This knowledge will have to be connected with the acquisition of knowledge from the accompanying areas from the production process of textile fibers, the areas of production of textile flat products to the area of marketing, finance, optimization of production time and its organization, machine building and information technologies, ect...

The first stronger microprocessor, which can be said to have significantly affected the development of the CAD / CAM system, appeared in the clothing industry in 1978. The rapid development of the garment industry has led to the fact that today microprocessors are installed in machines for laying of stock materials, in aggregates for cutting out of cuttings, in sewing machines, in interphase transportation systems... The development of the microprocessor has led to the development of CAD systems for structural preparation in the garment industry today, as 3D graphics can be supported in a satisfactory way. Moving images can also be generated which allows simulation of dynamic wearing of clothing. In addition to the enviable level, the ability to recognize and interpret the images has increased, which led to the significant development of the robotic visualization system in clothing technology [1-3].

New areas in clothing technology that are developed thanks to powerful computers are definitely: dynamic simulation of the appearance and wear of designed clothing, numerical guidance of sewing machines and sewing robots, a new area in which intelligent sewing machines are developed, dynamic optimization of material consumption, production simulations clothes on computers, etc. [4].

## 1. APPLICATION OF CAD SYSTEM

Design and clothing design process is complex and transforms the flat two-dimensional materials into the corresponding three-dimensional shape of the garment.

A variety of parameters that define textile surfaces, rapid changes in fashion trends, and a small series production condition the way of making a garment. In order to make the emergence of a garment from the requirement for its creation, and until its appearance on the market, it would be necessary to provide a controlled, continuous and automated production flow with reduced consumption of human labor, materials and energy [5].

Modern technologies of clothes production are characterized by the fact that their consumption of direct live work on machines is reduced, etc., and the share of itelektual - indirect live work is increasing (time for preparation of technological documentation and implementation of work orders, design, programming, design and modeling of clothing, matching images, simulations, etc.). Modern production is based on knowledge, new products, information technologies and the like. All this affects the rapid development of new products, the introduction of innovations, flexible production, new materials. In addition, it is important to develop new ways of testing materials and processing conditions in order to gain competitive advantages in the market. [6-8]

## 2. NUMERICAL GUIDING SEWING MACHINES

In numerically guided sewing machines, spun parts, like sewing machines and aggregates, are automatically driven during sewing on a fixed line of seams on the basis of stored numerical data. Numerical data is stored in the memory of the processor, and relates to moving the sparkling parts during sewing. During the handling of parts it is possible that:

- The distorted part is stationary, and the sewing machine head is wiping the line of the seam
- Bending on one axis is carried out by machines, and a broken part of the i is moved along the other axis
- To spin out a piece of bends from both axes, and the sewing machine head is stationary.

Numeral sewing machines are often referred to as NC sewing machines. The name comes from the English word Numerical Control, which can be translated in our language as numerically guided by a computer. NC-guided sewing machines can be classified according to the numerical marking method, the data input method and the numerical-driven method. [9]

### SPRINT 6 – FLEXIBLE MACHINE WITH ONE HEAD AND FREEDOM HAND

Procurement of an industrial bonding machine is always an important decision to start a new store or to expand existing capacity.

Production ZSK embroidery machines takes place in the production facilities in Krefeld and Remscheid.

**SPRINT 6** is a compact, free-hand machine that, in terms of quality, precision and durability, does not deviate from the industrial bonding of the SOK machines. With the newly developed free hand, which is the smallest in the industry, it enables the creation of connections in inaccessible places and at the same time increases the field of work in some applications. **SPRINT 6** with its light weight is the ideal machine for fast and mobile services. The low level of noise generated by the machine during operation allows the use of the same in stores and fairs. The machine is also delighted to use sports facilities, golf tours, shopkeeper riding equipment and designer boutiques.

**SPRINT 6 and SPRINT XL** are the latest models of popular sprinkling machines with one head of the SPRINT series.

**SPRINT 6** - With a useful 460 x 310 mm binding field, the SPRINT 6 model offers the perfect dimensions for individual end-user buckets, customized orders for the advertising industry and designed embroidery for fashion shows.

**SPRINT XL** - is the perfect choice for extra large items such as flags or bath towels. The binding field of max. 1200 x 280 mm offers the necessary room for such "big" jobs. [10]



Picture 1: Sprint 6 and Sprint XL single-head machine



Picture 2, 3: Display of the automatic binding machine

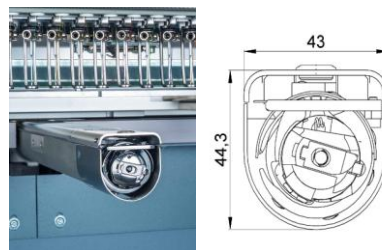

Picture 4: Display of the tubular arm and adjustment of its height

## ADJUSTING A NEW HEIGHT OF THE HEAD

- The smallest tubular arm in the industry
- Allows embroidery in places that are almost impossible to reach (pockets, shoes...).
- Works without a fold on the front; textiles are no longer considered to be a picking fabric or pulling the hook to the inside.
- The finest permeability on the tubular arm.

## **T8-2 CONTROL TERMINAL - MAIN DEVICE FOR A DIGITAL MONITOR MACHINE**

Intuitive and logical use

- • Ready for networking.
- • Accept all common industrial binding codes.
- • It can work in 14 languages.
- • Storage up to 80,000,000 seams.
- • Bar code capability.



*Picture 5: Control terminal T8-2*

## **J SERIES - Responsible for rapid changes**

Series J ZSK Link Machine is a group of machines with the free hand of state-of-the-art technology. The J series is recognizable by its universality of the ability to tie on tailored goods, ready-made garments, hats and a boarding frame. The concept of the machine is a versatile work with the use of a wide range of SOK accessories. The advantage of the principle of construction is the acquisition of a small working space, the relatively low weight of the machine and thanks to the transport wheels mounted on the machine - the mobility of the machine inside the workspace.

The ability to quickly change the operating mode depending on the work task in production, the machine offers the optimum possibility of utilization in case it requires maximum flexibility. [10]



*Picture 6.: J - SERIES machines – freehand*

Frames for embroidery machines:

Frames for free-hand machines / frames for flat machines. The use of SOK free-arm frames provides high speed fasteners on t-shirts, sweatshirts, towels, sportswear ... etc



*Picture 7: Frame for flat machines*



Magnetic frames 260 mm x 320 mm - Magnetic frames simplify the bond on unsuitable tensile materials for the classic frame.



*Picture 13: Magnetic frames*

Frame for socks - Frame for socks was developed for making the connection to the trousers. The ram stands out with a particularly large working area of 260 mm to 60/95 mm.



*Picture 14: Frame for socks*

Tape embroidery machine 15-35mm - The tape embroidery machine keeps the tape from the roll on the roll and allows for automatic bonding on the material.



*Picture 15: Tape binding apparatus*

## **Tile machine**

Sealers are taking the lead in the world market. First of all, high steady precision and speed guarantee production without competition. The attachment of the machine, combined with the sewing machines, offers unlimited possibilities for creativity. Through the unique bonding method developed by SOK and using EPCwin-Software, an increase in productivity is up to 25% higher than the productivity of competing machines.

The use of the Sik Squirting Machine provides the production of perfect characteristic textiles. Single and twin shredding machines give the ability to work with 3-19 mm shingles and accept shingles of various shapes with different position of the hole. In addition to working with two devices for twisting twigs, you can use 4 types of seals with different size and shape in one piece. Sewing machines give the ability to quickly change the size of the seals. Hanging tins, where the hole for fixation lies on the upper edge of the seal, give completely new creative possibilities.



*Picture 16: Tile machine*

### **Drill**

Pegs extend the design abilities and increase the value of connections. All standard machine attachment heads are designed to use drillers and can be installed on the machine at all times. The drill is a tool with four sharp edges that drills a hole in the material. The needle and thread open a drilled hole and make a bond at the edge of the hole.

To optimally use the creative capabilities of the tools, it is recommended to use ZSK software for the production of mustra EPCwin or BasePac. With the help of ZSK drillers you can create high-quality motives. Most often such motifs are used on women's blouses, curtains or tablecloths.



*Picture 17: Display of the drilled fabric*

### **SPECIAL MACHINES TO HEAD AND W WRAPS**

Embroidery machines with special effects provide you with everything necessary for the realization of ideas in the application connections outside the standard framework. Special machines are based on 3 different heads, which individually or in combination make saunas new effects. They indicate high productivity, easy operation, high precision of connections in a high degree of reliability.

### **K head**

K-head machines are for the production of textured 3D links with automatic color change of up to 6 threads, with an automatic end-cutter. The drive concept with 4 individual stepper motors per head permits individual variations of the main functional elements, i.e. needles, stops and end gauges. The concept of drive with individual stepping motors is the basis for quality and productivity. The head can be combined with a standard binding head or with a W head. The combination of various types of connections in a single seal opens up new possibilities in the realization of ideas.



*Picture 18: Display of embroidery machine with K head*

### **W head**

Special machines with W head are capable of replenishing effective yarns, tape and achieve completely new effects in the binding image. The creation of motives that so far could only be carried out with manual work with the help of SSK special machines enter the regular industrial production program. Depending on the nature of the yarn used and the desired side effect, you can choose between the tape, coil or zigzag mode. Effective yarn is introduced directly through the needle via a free moving spool.

The upper thread is mainly used for fastening the tape. For the multicolor embroidery, the W head extends with the stranded head for the bond, thereby increasing the possibilities and variety of work.



*Picture19: Display of embroidery machine with W head*

## **CONCLUSION**

The paper describes nc guided machines in the clothing industry. Nc systems are control units that are based on the computer generated command for the executive organs of the machine, based on the given motion coordinates and commands. The paper explains that numerical sewing machines are often referred to as nc sewing machines. It is explained that the name comes from the english word numerical control, which can be translated in our language as numerical guidance using a computer. Also, it has been explained that the numerical programming method for nc guided sewing machines uses numerical values of the position of points on the paths of the seam lines that can be defined by rectangular polar coordinates. On this basis, it is possible to use: the gradual marking method or the absolute marking method. The gradual marking method of the position of a certain point was determined as the value of the increment in relation to the absolute marking method. The method of absolute marking of the position of a certain point is determined in relation to the starting point and represents the position of the point relative to the value of its coordinates in relation to the starting point. In this paper, for the garment industry, selected spinning aggregates as well as nc guided sewing machines, embroidery, etc. Were selected.



## REFERENCES

- [1] Ujević D., Šajatović B., Doležal K.: “*Novel achievements in the technological process of garment manufacturing*”, 6<sup>th</sup> International Scientific Conference RIM 2007 Development and modernization of production, 2007., pp 207
- [2] Ujević D., Rogale D., Tržić D.: “*Razvoj i primjena računalne podrške u procesima proizvodnje odjeće i tehničkog tekstila*”, Tekstil 51, 5, 2002., pp.224-229.
- [3] Rogale D.: “*Odjevna tehnologija na svršetku milenijuma – stanje i predvidivi pravci razvitka*”, Tekstil 47, 1, 1998., pp.2-19.
- [4] Petrović V., Stepanović J., Popov –B.D., Reljić M.: „*Optimizacija tehničke pripreme upotrebom CAD sistema za konstrukciju odeće*“, Beograd, 2015
- [5] Čolović D., Paunović D. : „*Savremene organizacije proizvodnje odeće*“, MDT, 2015.
- [6] Stojiljković D.T, Petrović V., Petrović – Dj. M.: *Rheological modelling of yarn extension*, Tekstil 56, 9, 2007., pp.554-561.
- [7] Šejn D.: “*Vpliv materijala na kakvost šiva*”, Tekstilec 50, 2007.,4-6, pp.77-92.
- [8] Petrović V., Stepanović J., Stojiljković D., Popov –B.D.:“*Analiza uticaja opremljenosti proizvodnih linija na vreme izrade odeće*“, Menadžment, Inovacije, Razvoj 3, 6, 2008., str. pp.52-55.
- [9] Rogale D., Ujević D., Firšt Rogale D., Hrastinski M. : *Tehnologija proizvodnje odeće sa studijom rada*“, Tekstilno – tehnološki fakultet u Zagrebu, 2005.
- [10] <http://www.zsk.de/single-head-embroidery-machine-sprint.html>

## CAMBODIAN SILK

Veasna Tith

The Royal University Of Fine Art

veasna.tith@gmail.com

### INTRODUCTION

Cambodia is a country in Southeast Asia with a long history of great culture and tradition. Weaving is a Khmer craft that has existed since the *Funan* period. However, some researchers have said that the Khmer could produce silk product with different decorative patterns, such as *Iboek prealeat*, *angloun* (Checked cloth), *kroma*, (scarf), *sarong sotr*, *chorabab*, *soeung*, *hol*, *phamuong*, *pidan* ( used in Buddhist ceremonies) in magnificent colors, which were extracted from trees and other materials. [For a long time] people have been using these types of materials for clothes and in decorations because of their glorious natural colors. This craft [weaving] is clearly apparent on the artistic skirts of the Apsara on the walls of Angkor Wat and other temples in the wonderful territory of the Kingdom of Cambodia.

Clothes made from silk include *hol*, *phamuong*, *chorabab*, and *sarong sotr*; these traditional Khmer clothes have long been used by ordinary people, low and high-ranking officials and the king. Although today there are many modern clothes imported from foreign countries or produced locally, *hol*, *phamung*, and *chorabab* are still popular in wedding ceremonies, traditional festivals and royal ceremonies.

What are the processes of weaving and natural dyeing? In fact, it is a very hard work to weave *hol*, *phamuong*, *sarong sort*, *chorabab* to produce one skirt or one *kbin* for clothing or Khmer-style decorations for places organized to attract foreign tourists. It costs craftsmen not only money to buy the silk but also mental effort and talent. However hard it is, they work on it with diligence.

We believe that result of research on natural dyeing is vital proof to show different patterns of silk weaving and natural dyeing to all Khmer people who wish to operate business in Khmer silk products made from natural dyeing but serves as a document to preserve Khmer traditions and customs for the next generation.

#### *History of Silk in Cambodia*

The silk industry started in Cambodia during the 13<sup>th</sup> century, then known as the Khmer Empire. Chinese diplomate Zhou Dagan visited the region at that time and reported the beginning of silk activities. Those developed along the Mekong and Bassac River in the south of Phnom Penh with mulberry plants to breed silk worms. The bas-reliefs of Angkor Wat and Bayon reflect these changes as Apsaras costumes display geometrical patterns similar to the Indian Ikat technique named Patola. From the 19<sup>th</sup> century until the 1970s, the weaving technique developed and the industry spread to the Tonle Sap, the largest lake in Southeast Asia, and to settlements such as Battambang and Siem Reap. As the skills had evolved, Cambodian Ikat, the dyeing technique to produce unique patterns, gained universal recognition in the 19<sup>th</sup> century. Around a quarter of families lived thanks to silk production at that time.

From the 1970's, the silk industry was disrupted under the Khmer Rouge regime which almost destroyed the industry. They strictly limited colored clothing and imposed black pajamas for the population. The Vietnamese intervention in 1979 did not benefit the silk industry which slowly recovered only after the 1993's transitional government.

## Hol

*Keidh* is a skein of silk which weavers tie for dyeing, in English called *ikat*. Khmer weavers have their own special technique to do that. White *keidh* was first dye with red, then with yellow and lastly with blue.

To tie the *kiedh* we use young banana sheath, but today it has been replaced by nylon. There are some organizations still preserving this technique, for example the institute for Traditional Khmer Textile located in Siem Reap. According to Khmer superstition, people believe this kind of banana trees cannot be planted near their houses.

There are many patterns of *hol* in Khmer tradition, which were created by weaver from generation to generation. Through the interviews with old weavers, we found that in the past, to produce one *kben* of *hol*, they had to spend at least three months to complete the work. This takes a long because they need to feed cocoons pattern were bigger than those of today, such as *phnek Ko* (cow eyes), *klim chan*, double lines... etc.

To get a high quality of *hol*, the weaver needs to have rich experience and diligence, and take great care.

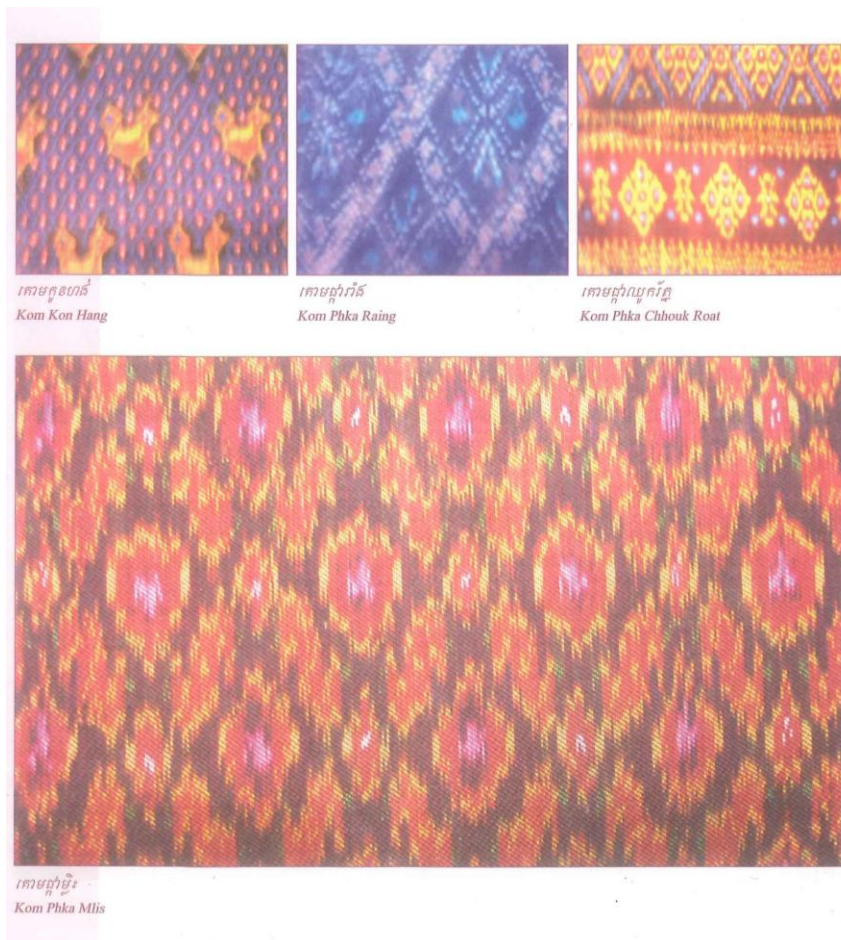

## Phamuong

*Phamuong* is a kind of Khmer weaving product that has many colors, as required by users, but generally has only one color per piece. We remember that recently *Phamuong Kor Tea* (the color is similar to the color of a duck's neck) has been very well known.

Weavers use at least three *thkor* or more if that *phamuong* has a pattern or hem decoration. In *Koh Dach*, weavers use up to 30 *thkor* for one called *phamuong tbong pich* (diamond phamuong), which has now become popular.



វត្តភ្នំស្រីស្រី  
 Hem of Phamuong, Angkor pattern

### *Chorabab*

Nowadays, *chorabab* is only produces in *Khsach Kandal* district, *Kandal* province. People use *chorabab* in wedding and blessing ceremonies. The way to produce *chorabab* is similar to how to make *hol* and *phamuong*. There is a kind of cloth similar pattern s such as *kantout* flower, *chan* flower, and diamond. There is a kind of cloth similar to *Chorabab* called *lboek*. *Lboek* is different from *chorabab* because *chorabab* use *sesoy* to show up the pattern or flowers, but *lboek* uses silk instead. Weavers use a lot of *thkor* to produce *chorabab*; in some case they use sixty *thkor*.



វត្តភ្នំស្រីស្រី  
 Chorabab Phka Chan

### *Sarong Sotr*

Khmer *Muslim* likes to use and wear it not only at home but also in big ceremonies. The pattern of sarong is not complicated and has a few models like *dom ach cvea*, which is quite well-known and *sarong sotr*



វត្តភ្នំស្រីស្រី  
 Kram Cham Ach Jva Bon Prek Chantkan

*Scarf*

Every person has at least one scarf (*krama*). We mostly use scarves made from cotton and cotton-silk (more expensive). It is a part of Khmer tradition.

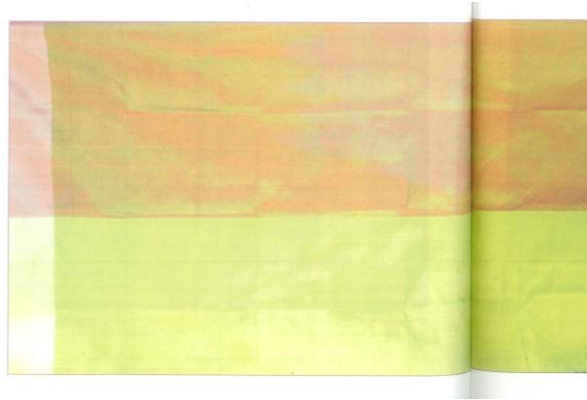

*Pidan and Roneang*

This is used only in Buddhist ceremonies. The pattern on *pidan* illustrates the life of Buddha, nature, flowers, animals and Apsara.

The way to produce *pidan* or *roneang* is almost the same as the way we make *hol* because the silk has to be tied and dyed. It is currently only produced in *Bati* district, Takeo province.

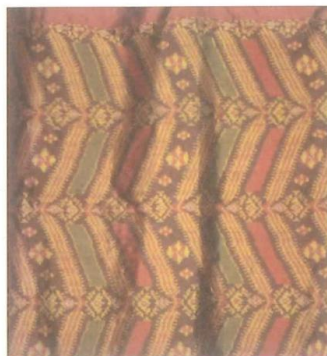

ពិដាធមាធិបនាគមកពីខេត្តសៀមរាប  
 Picture of naga from Siem Reap

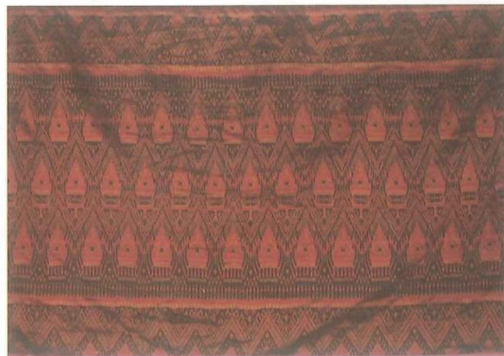

ពិដានូវបុត្រាសាទនេះមានដាក់គំរូនៅអង្គការពិភពកុមារខ្មែរខេត្តកែវ  
 Pidan at CYK, Bati district, Takeo province



ពិដាធិបាយពីការចេញរបស់ប្រាជ្ញានេះមានដាក់គំរូនៅអង្គការពិភពកុមារខ្មែរ ខេត្តកែវ  
 Pidan at CYK, Bati district, Takeo province

## REFERENCES

- [1] Documentations on Khmer tradition, The Buddhist institute 1999
- [2] Method to produce Hol of Khmer women, Ly Sovy, Phnom Penh 1998
- [3] Book on Pattern study of khmer Hol , Phamuong , Silk by Cambodian craft cooperation
- [4] Ms. Prang Sun, Phnom Penh.
- [5] Book TECHNIQUE of Natural Dying and traditional Pattern on Silk Production in Cambodia , by Sor Sokny , Miss Phat Chanmony Ratha, Mr. Som Vannak, 2007(ISBN978995050023)

## PRESSING PERFORMANCE OF WOVEN FABRICS FOR MEN'S SUIT

Maja Jankoska\*, Goran Demboski

University "Ss. Cyril and Methodius", Faculty of Technology and Metallurgy,  
Department of Textile, 1000 Skopje, North Macedonia  
e-mail: maja@tmf.ukim.edu.mk

### ABSTRACT

*The influence fiber composition and weft density variation on pressing crease angle have been investigated on wool and wool lycra worsted woven fabrics for tailored garments. Pressing performance has been investigated on a FAST press tester. Obtained results show that the increasing of fabric weft density affects decreasing pressing crease angle which positively influences garment seam appearance. The wool lycra fabrics and 100% wool fabrics behave differently regarding pressing crease angle in warp and weft directions.*

**Keywords:** press test, FAST press-tester, crease angle, woven fabric

### INTRODUCTION

Superior tailored garment appearance is universally desirable and derives from the combination of style, suitable choice of fabrics, tailoring skill and successful pressing. Steam pressing is an important procedure which is extensively and repeatedly used in the garment industry, both during garment manufacture and in the aftercare processes of dry cleaning and laundering. Pressing represents the final opportunity to impart shape, flatness, creases and other desirable attributes to the garment. Many research workers have investigated the pressing conditions in order to optimize steam pressing (Kopke V., Lindberg J., 1966, Baird K., 1968, Kalecki *et al.*, 1974, Rosenblad-Wallin E., Cednas M., 1974, Pharo J.A, Munden D.L., 1978, Dhingra R.C., Postle R., 1980). In practice, however, the pressing temperature has been limited within a narrow range. Steam-pressing, either with live steam or with a wet cloth and an iron, is an old and very important process, by means of which temporary set is introduced in wool fabrics. Large variations in the efficiency of pressing are always obtained in practical work, and opinions concerning the conditions that will give the best results differ widely. From a technological point of view, surprisingly little is known about the steam-pressing process.

Sustmann has made a systematic study of the temperature and moisture changes in a wool fabric treated in a conventional steam press. The press was not completely closed during the experiments, and the distance between the press plates was large enough to enable the cloth to be moved. Since the moisture-regain changes recorded were small in all experiments, Sustmann C., (1957) concluded that the setting of a wool fabric in a conventional steam press was due only to the moisture in the fabric itself in combination with the temperature increase caused by the steam. The results of a steam-pressing operation, however, must be judged by the setting effect obtained in the garment, and in neither of the studies referred to above was the degree of setting measured. In fact, there does not seem to have been any systematic study made of the setting effect of steam on wool fabrics as a function of time, temperature, and moisture regain. Some authors (Astbury W.T. *et al.*, 1933, Speakman J.B., 1933) studied the setting effect of steam and water on wool fibres, but for steam the moisture regain of the fibres during the treatment was not known or controlled. It is therefore doubtful whether the results can be used to predict the degree of setting obtained under various conditions of steam-pressing. Le *et al.* (1995) studied the effects of decatizing treatments at various temperatures and regains on the pressing performance of wool fabrics. The pressing performance is strongly affected by fabric regain and the level of set imparted during decatizing treatments. It was proposed that the pressing performance of a wool fabric is comprised of two components, namely: temporary and permanent.

Poor crease retention at the seams may occur after pressing and results in an undesirable blown' appearance. Biglia *et al.* (1991) carried out industrial and laboratory trials to study the relationship between the garment appearance and measured fabric properties. They developed a simple measurement of fabric pressing performance indicated by the fabric crease angle. A low crease angle is a necessary but not sufficient condition for a good pressed seam appearance. It was concluded that crease angle can be used in combination with fabric formability as measured by the FAST set of instruments (Ly *et al.*, 1988) to give an assessment of garment appearance of light-weight fabrics after pressing. Tester *et al.* (1995) found that the weft crease angle should be considered as more important for garment appearance. A high quality, pure wool structured garment is pressed as one of the final processes in garment manufacturing. The aim of this paper is to investigate the influence of fibre composition and weft density variation on pressing crease angle.

## EXPERIMENTAL PART

### Materials and Methods

The objects of the investigation are worsted woven fabrics for tailored garments. The details of fabrics structure parameters are shown in Table 1.

The fabrics are arranged in two pairs of different fibre composition. The second fabric in the pair has increased weft thread density. The samples WL2 and W2 have higher weft density than its pair WL1 and W1. The first pair fiber composition is wool lycra, the second is 100% wool.

*Table 1: The characteristics of the fabrics tested*

Fabric	WL1	WL2	W1	W2
Fiber composition	98% wool 2% Lycra		100% wool	
Warp count, tex	17x2		17x2	
Weft count, tex	17x2		17x2	
Warp density, cm <sup>-1</sup>	32		30.8	
Weft density, cm <sup>-1</sup>	24.8	26.2	25.6	28.2
Fabric thickness, mm	0.36	0.41	0.39	0.41
Fabric weight, g/m <sup>2</sup>	213	227	213	227
Finishing	standard		milled	
Weave	2x1 twill		2x2 twill	

The fabric pressing performance was assessed using the developed setting jig (Rosenblad-Wallin E., Cednas, M., 1974) and IWTO draft test method (IWTO Draft Test Method, 1981). The pressing apparatus is shown in Figure 1. The crease angles are measured using an optical device shown in Figure 2.

The sample should be conducted in the standard atmosphere 20°C and 65% R.H. for at least 16 hours (overnight) before cutting. Six 4 cm x 2 cm test specimens are cut from each fabric (three samples by warp and three samples by weft). Each specimen is folded in half so that the crease formed is parallel to the shorter side, with the back of the fabric inside the fold. The samples are then placed in the setting jig, where the temperature is raised and then lowered. After the samples are removed from the jig they are allowed to recover under standard conditions for 24 hours before the crease angles are measured.

The instrumentation was designed to mimic the action of a steam press.



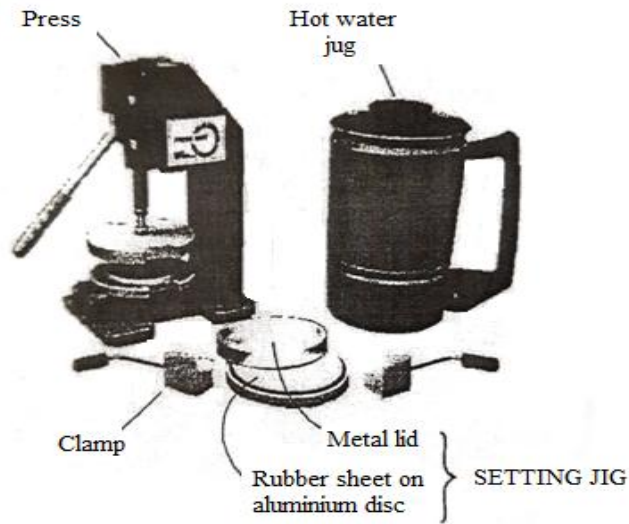

Figure 1: Pressing performance crease setting device

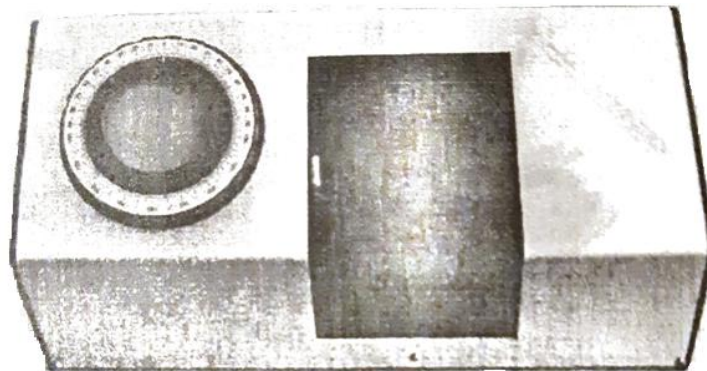

Figure 2: Pressing performance crease angle measurement instrumentation

**RESULTS AND DISCUSSION**

Table 2 and Figure 3 show the results of pressing performance crease angle of investigated fabrics.

Table 2: Pressing crease angle of investigated fabrics

Fabric	Crease angle (CA), °	
	CA-1 (warp)	CA-2 (weft)
WL1	123.5	103.5
WL2	100.5	84
W1	104.5	117.5
W2	61.5	84

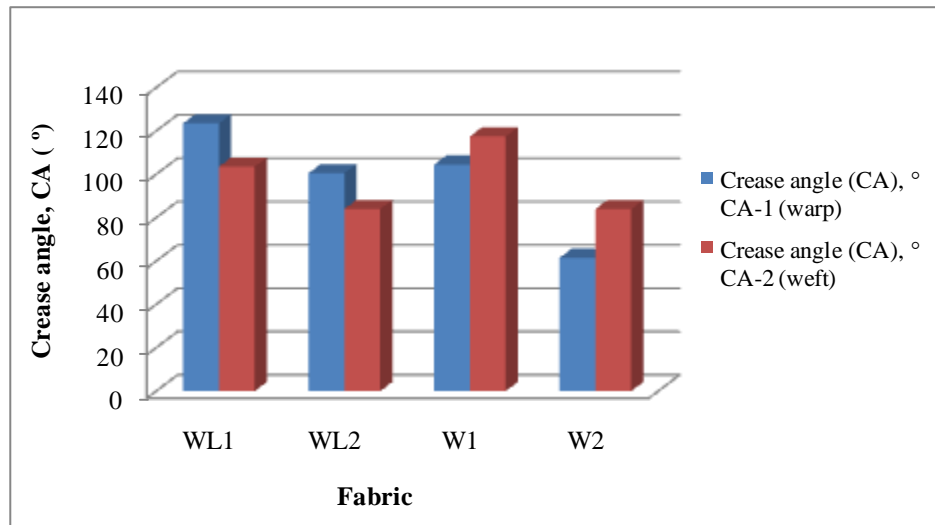

Figure 3: Crease angle (CA) for investigated fabrics

Comparison of fabrics WL1 and WL2 shows, that the fabric WL2 of higher weft density, obtains lower crease angle by warp and weft (100.5 ° and 84 °), whereas fabric WL1 has a higher crease angle of (123.5° and 103.5 °). A smaller crease angle produces a flatter, crisper seam. A fabric with a large crease angle tends to show 'blown' seams, and hence a worse appearance (in this case WL1).

The 100 % wool fabrics W1 and W2, show the same behavior: the increase of weft density (W2) results in decrease crease angle in both warp and weft direction. So, generally, the increasing the weft density contributes to improved pressing properties in warp and weft direction for all investigated fabrics. The increasing of the weft density results in lowering the crease angle for 19 ° in both directions for wool lycra fabrics. For 100 % wool fabrics, the increase of weft density results in decreasing pressing crease angle for 41 ° in warp and 29 ° in weft direction. So, the effect of increasing weft density on crease angle is greater for 100 % wool fabrics. The results could be attributed to fibre content and to degree of increasing weft density. Namely, increasing of the weft density in the is 24.8 cm<sup>-1</sup> to 26.2 cm<sup>-1</sup> or 5.6 % for wool lycra fabrics and from 25.6 cm<sup>-1</sup> to 28.2 cm<sup>-1</sup> or 10.2 % for 100 % wool fabrics.

The wool lycra fabrics, WL1 and WL2, have higher values of crease angle in warp direction and lower in weft direction, *i.e.* fabrics perform better regarding seam blowing in weft direction. On the contrary, 100% wool fabrics obtain lower crease angle in warp direction and higher in weft direction. Therefore fabrics perform better in warp direction.

The aim of pressing is to give a smooth, crisp appearance to the panels and seams. If, during pressing, the seam cannot be made to lie flat and sharp, but tends to blow, then it is said to be 'blown', (Figure 4). Seam blowing can make a high quality wool garment unacceptable for sale, and occurs with increasing frequency in lightweight fabrics. The ability of a seam to be pressed flat is not directly related to other fabric properties, but can be modified during finishing. It is important, therefore, to be able to predict the seam-pressing performance of a fabric prior to cutting, so that remedial measures can be taken where required. Since the weft creasing angle is more important for garment appearance it seems that fabric WL2 and W2 obtain better pressing performance.



Figure 4: Seams pressing performance

## CONCLUSION

The influence of fabric structure variation and fibre content on the crease angle was investigated. The results obtained have shown that increasing of weft density result in lowering pressing crease angle and the incidence of seam blowing. It was shown the effect varies with the scale of increasing weft density.

The investigated fabrics behave differently regarding fibre composition. The wool lycra fabrics obtain higher values of crease angle in warp direction and lower in weft direction, while 100 % wool fabrics obtain lower crease angle in warp direction and higher in weft direction.

## REFERENCES

- [1] Kopke V., Lindberg J. (1966). Steam-Pressing of wool fabrics: The Influence of Temperature and Moisture Regain on the Efficiency of Pressing, *Journal of the Textile Institute Transactions*, 57(12), 551-573.
- [2] Baird K. (1968), Temperature and moisture regain of wool fabrics during steam pressing, *Textile Res. Journal*, 38, 670-674.
- [3] Kalecki E.H., Pharo J.A., Dorkin C.M.C., Munden D.L. (1974). Some factors affecting the degree of set achieved during steam pressing of all wool fabrics, *Clothing Research Journal*, 2(1), 11.
- [4] Rosenblad-Wallin E., Cednas, M. (1974). Pressing of seams and creases, *Clothing Research Journal*, 2(3), 115-121.
- [5] Pharo J.A., Munden, D.L. (1978). An investigation of the performance of wool/polyester blend fabrics during steam pressing, *Clothing Research Journal*, 8(2), 59.
- [6] Dhingra R.C., Postle R. (1980). Some aspects of the tailorability of woven and knitted outwear fabrics, *Clothing Research Journal*, 10(6), 39.
- [7] Sustmann C. (1957). *Melliand Textilber*, 38, 452
- [8] Astbury W.T., Woods H.J. (1933). *Phil Trans. Roy. Soc.*, 232-333.
- [9] Speakman J.B. (1933). *Wool Rec.*, 43, 205-263.
- [10] Le V.C., Biglia U., Tester D.H., Sarlej L.M. (1995). Proc. 9th Int. Wool Text. Res. Conf. Vol. V,3, Biella, Italy.
- [11] Biglia, U., Roczniok, A.F. and Ly, N.G. (1991), *The prediction of garment appearance of wool fabric*, in, Proc. of Textile Objective Measurement and Automation in Garment Manufacturing, Bradford University, UK, 175-178.
- [12] Ly N.G., Tester D.H., Buckenham P., Roczniok A.F., Brothers M., Scaysbrook F., de Jong, S.(1988). *Simple Instruments for Quality Control in a Tailoring Company*, IWTO Tech, Cttee Meeting, Paris, December, Report No. 11.
- [13] Tester D., Roczniok A., Minazio P., Mello P., Fleiss C. (1995). *The pressing Performance of Wool Fabric*, in Proc. 9th Int. Wool Text. Res. Conf. Vol. V, 20, Biella, Italy, 3-10.
- [14] IWTO Draft Test Method (IWTO TM 42-02) Crease Pressing Performance Test. 1981.

# ANALYSIS OF CHARACTERISTICS OF THE WOOL YARN AND MIXTURES OF WOOL AND POLYAMIDE YARN FOR KNITTING SWEATER

Dragan DJORDJIC<sup>1\*</sup>, Mirjana RELJIC<sup>1</sup>, Jovan STEPANOVIĆ<sup>2</sup>, Vasilije PETROVIC<sup>3</sup>

<sup>1</sup>CIS Institute, Belgrade, <sup>2</sup>University of Nis, Faculty of Technology Leskovac, <sup>3</sup>University of Novi Sad, Technical faculty "Mihajlo Pupin" Zrenjanin  
ddjordjic@yahoo.com\*

## 1. ABSTRAKT

In this paper have been studied, changes of parameters such as fineness, breaking force and elongation, the coefficient of variation, number of twist in pure wool yarn and wool mixed with polyamide before the knitting process (from packages), yarns sampled from knitwear and in a ready-made garment (after finishing). Diagrams as well as tables with fineness values are presented, number of twist, breaking force and elongation, coefficient of variation in order to better present the results and to understand the changes that the yarn passes during process of knitting.

**Key words:** wool, yarn, knitwear, breaking force, breaking elongation

## 2. INTRODUCTION

Wool as a raw material whose use for human needs dates back to prehistory, due to a number of positive properties, is still almost irreplaceable today and is used for fashion as well as for the technical needs of a modern man.

Wool is produced by [follicles](#) which are small cells located in the skin. These follicles are located in the upper layer of the skin called the [epidermis](#) and push down into the second skin layer called the [dermis](#) as the wool fibers grow. Follicles can be classed as either primary or secondary follicles. Primary follicles produce three types of fiber: [kemp](#), medullated fibers, and true wool fibers. Secondary follicles only produce true wool fibers. Medullated fibers share nearly identical characteristics to hair and are long but lack crimp and elasticity. Kemp fibers are very coarse and shed out.[1].

Wool and hair are multicellular natural fibrous materials, composed of three layers: cuticle, cortex and medulla. The wool is hygroscopic, which means it absorbs moisture. It can absorb up to 33% of its weight, while polyamide can 4.5% and polyester only 0.4%. [2].

Felting of wool occurs upon hammering or other mechanical agitation as the microscopic barbs on the surface of wool fibers hook together. Wool has several qualities that distinguish it from hair/fur: it is [crimped](#) and [elastic](#)[3].

## 3. EXPERIMENTAL

In this paper, two yarns of different composition were examined. The first is 100% wool, the article "Casa del filato prato" and the other is 80.9% wool and 19.1% polyamide, the article "New mill". Changes are followed in the physical-mechanical characteristics of the yarn from the packages, yarns sampled from knitwear and in a ready-made garment (after finishing). All tests were performed according to SRPS and ISO standards, of which the following standards were used for the following tests:

SRPS EN ISO 2060 - Textiles - Yarn from packages - Determination of linear density (mass per unit length) by the skein method[4]

SRPS EN ISO 2062 Textiles - Yarns from packages - Determination of single-end breaking force and elongation at break using constant rate of extension (CRE) tester[5]

SRPS EN ISO 2061 Textiles - Determination of twist in yarns - Direct counting method [6]

For chemical testing

SRPS EN ISO 1833-4 Textiles - Quantitative chemical analysis - Part 4: Mixtures of certain protein fibres with certain other fibres (method using hypochlorite) [7]

SRPS EN ISO 1833-7 Textiles - Quantitative chemical analysis - Part 7: Mixtures of polyamide with certain other fibres (method using formic acid) [8]

For all tests, the following equipment was used:

- Laboratory balances of the manufacturer - Mettler
- Reel of the manufacturer - Zweigle kg Reutlingen
- Tensile test machine of the manufacturer SDL ATLAS- Tinius Olsen.
- Yarn twist tester of the manufacturer- Zweigle kg Reutlingen

In table 1 is shown the results of the physical-mechanical characteristics of the yarn made of 100% wool "Casa del Filato prato", and in Table 2 for the article "New mill".

*Table 1. The results of the physical-mechanical testing of wool - article (casa del filato prato)*

PARAMETERS OF EXAMINATION	STANDARDS	YARN FROM PACKAGES	YARNS SAMPLED FROM KNITWEAR	YARNS SAMPLED FROM A READY-MADE GARMENT (AFTER FINISHING)
COMPOSITION: -Wool	SRPS EN ISO 1833-4	100 %		
LINEAR DENSITY	SRPS EN ISO 2060	155,1x1 tex	155,2x1 tex	148,9x1 tex
BREAKING FORCE -mean value - coefficient of variation of breaking force	SRPS EN ISO 2062	3,58 cN/tex 555,7 cN 6,4 %	3,20 cN/tex 498,0 cN 5,8 %	2,17 cN/tex 323,1 cN 8,2 %
BREAKING ELONGATION	SRPS EN ISO 2062	17,9 %	17,7 %	12,7 %
SINGLE TWISTED YARN	EN ISO 2061	Z 258	Z 266	Z 287

Following changes of breaking force and elongations for yarn sampled from the packages, art "Casa del Filato Prato", is shown in fig. 1, yarns sampled from knitwear on fig. 2 and for yarn sampled from the finished product on fig. 3.

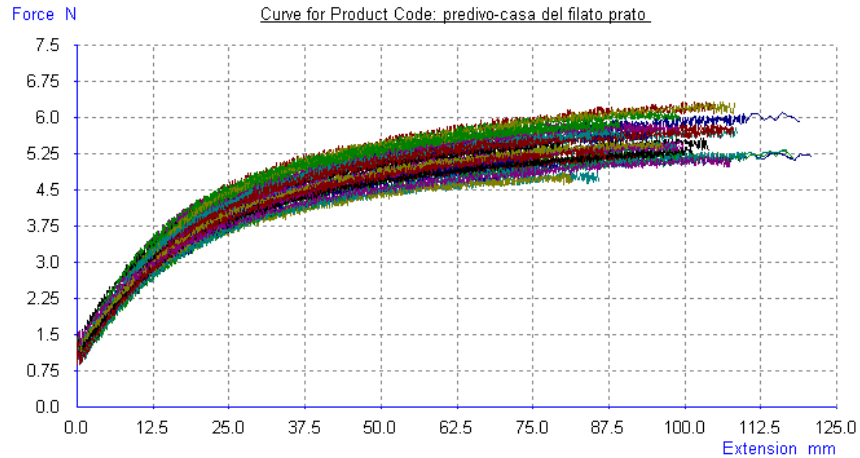

Picture 1. Yarn from packages, breaking force and elongation, art. "Casa del filato prato"

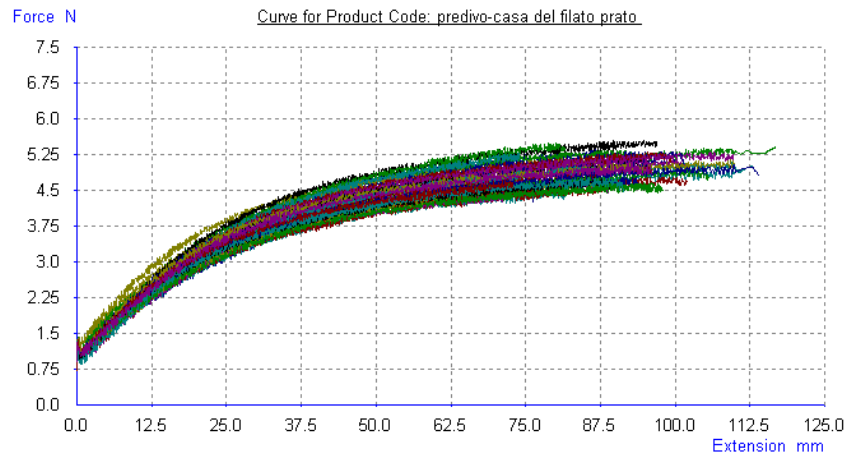

Picture 2. Yarns sampled from knitwear, breaking force and elongation, art. "Casa del filato prato"

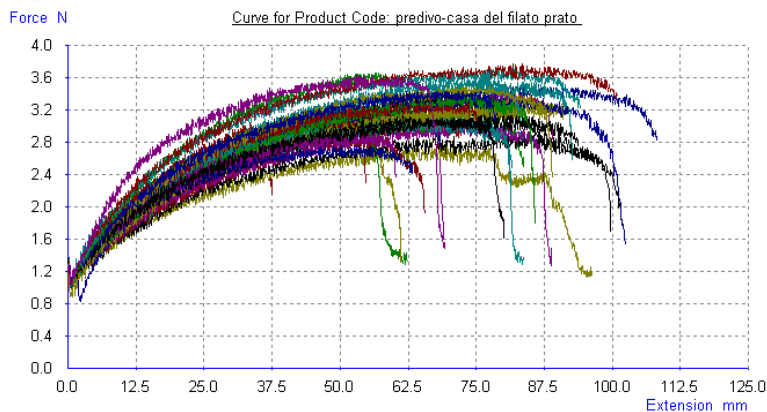

Picture 3. Yarns sampled from a ready-made garment (after finishing), breaking force and elongation, art. "Casa del filato prato"

*Table 2. The results of the physical-mechanical testing of wool yarn (80,9% wool and 19,1% polyamide mixture) article (New mill)*

PARAMETERS OF EXAMINATION	STANDARDS	YARN FROM PACKAGES	YARNS SAMPLED FROM KNITWEAR	YARNS SAMPLED FROM A READY-MADE GARMENT (AFTER FINISHING)
COMPOSITION: -Wool -Polyamide	SRPS EN ISO 1833-7		80,9 %  19,1%	
LINEAR DENSITY	SRPS EN ISO 2060	67,8x1 tex	67,4x1 tex	63,7x1 tex
BREAKING FORCE -mean value - coefficient of variation of breaking force	SRPS EN ISO 2062	3,54 cN/tex  240,2 cN  9,6 %	3,07 cN/tex  207,4 cN  12,9 %	2,99 cN/tex  191,0 cN  11,4 %
BREAKING ELONGATION	SRPS EN ISO 2062	15,2 %	13,7 %	13,0 %
SINGLE TWISTED YARN	EN ISO 2061	Z 321	Z 326	Z 359

Following changes of breaking force and elongations for yarn sampled from the packages, art "New mill", is shown in fig. 4, yarns sampled from knitwear on fig.5 and for yarn sampled from the finished product on fig. 6.

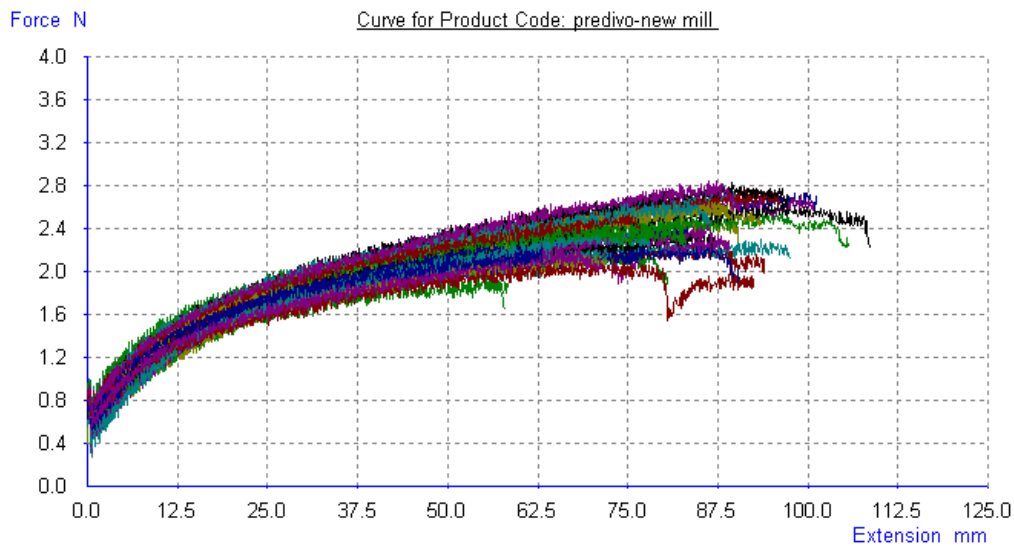

*Picture 4. Yarn from packages, breaking force and elongation, art. New mill*

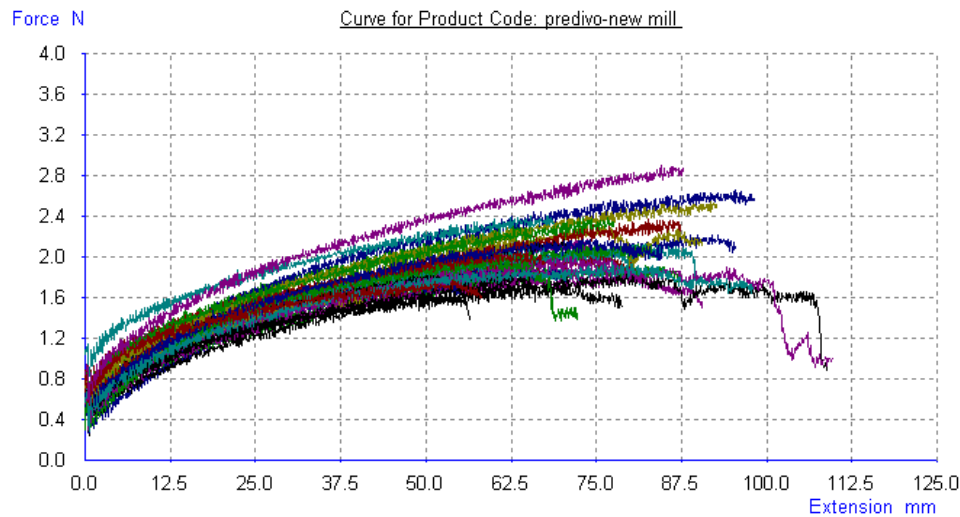

Picture 5. Yarns sampled from knitwear, breaking force and elongation, art. New mill

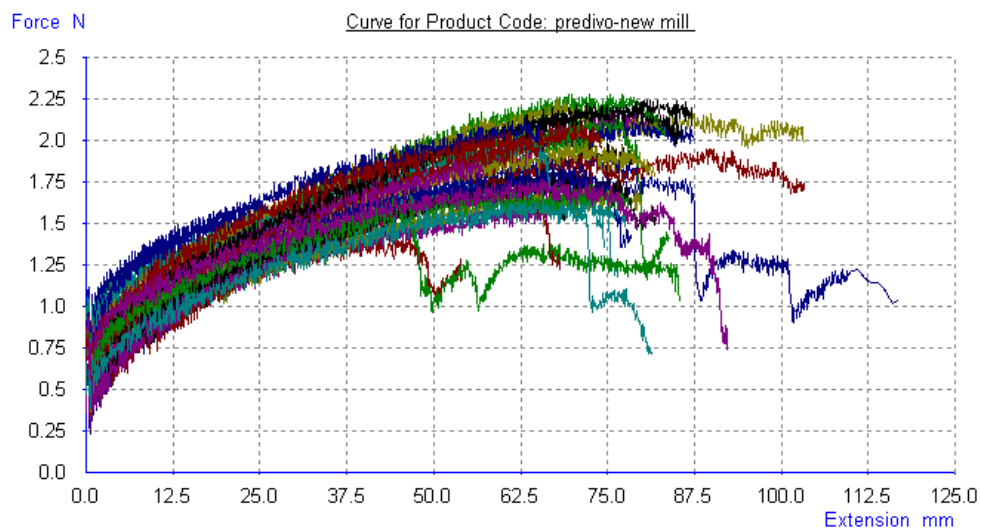

Picture 6. Yarns sampled from a ready-made garment (after finishing), breaking force and elongation, art. New mill

#### 4. DISCUSSION OF RESULTS

It can be noticed in tables 1 and 2 the changes in breaking forces, elongation, fineness of yarn, and number of twists, for both type of yarn.

In Table 1, where pure wool yarn was tested "Casa del filato prato" it can be noticed that the yarn from packages had a breaking force of 3.58 cN/tex, that this force should be significantly lower on the finished product of the value of 2.17 cN/tex. Oscillations and changes could be noticed by comparing figures 1 and 3. There is no significant change in the fineness of the yarn before finishing, whereas in the finished product it could be noticed that the yarn is rather finnier. The breaking elongation is slightly lower because the yarn partially loses its elasticity, so elongation of yarn from the packages is 17.9 %, and in the finished product is 12.7%. Coefficient of variation is higher in the finished product because the yarn becomes uneven after finishing (washing, softening and drying). The number of twist in yarn is minimally increased due to shrinkage of knitted yarn, after washing and finishing.



In the yarn “New mill” as well as in the yarn of a pure wool "Casa del filato prato", the finesse of yarn from the packages does not change in relation to the yarn sampled from the raw knitted fabric, while after the finishing the yarn is rather finer. The breaking force in this case too is also lower at the end of the knitting process of the finished product, which can be attributed to the tension that the yarn had been exposed to during knitting process. The tension occurs during the passage through the needles, winding on the cloth roller, washing, softening, drying and ironing.

All of these parameters has slightly influence the quality of yarn through the process of knitting up to the final product, but it is indisputable that the yarn loses on its quality and strength and especially if the wool is without the addition of other fibers.

Based on the shown tests herewith and the obtained results, it could be stated that the yarn made of wool changes its characteristics as it passes through the process of knitting, from the packages to the final product. This study showed that the physical-mechanical characteristics of the woolen yarn quality change in relation to the percentage of wool fibers, as well as the characteristics of other fibers mixed with wool.

## 5. CONCLUSION

The pure wool yarn has a significantly lower breaking force in the final product than the wool mixed with polyamide. The higher the proportion of the other fibers, the greater value of the breaking force in the final product, *i.e.* the loss in breaking strength is lower from the yarn from the packages than to the finished garment. Wool as one of the highest quality natural fibers, even in addition to these quality losses, such as a lower breaking force in the final product, especially in pure wool where it is significantly reduced, with the proper care, storage and wear, could last for many years. On the market, there is currently a large selection of agens for both the wool care and washing that keep the color and quality of wool garments and extend the useful life of the wool.

## 6. LITERATURE

- [1]. Simmons, Paula (2009). Storey's Guide to Raising Sheep. North Adams, MA: Storey Publishing. pp. 315–316
- [2]. Petar Škundrić, Mirjana Kostić, Adela Medović, Tatjana Mihailović, Koviljka Asanović, Ljiljana Sretković (2008). Tekstilni Materijali, Faculty of Technology and Metallurgy, University of Belgrade
- [3]. D'Arcy, J. B., Sheep and Wool Technology, NSW University Press, Kensington, 1986 [ISBN 0-86840-106-4](#)
- [4]. SRPS EN ISO 2060 - Textiles - Yarn from packages - Determination of linear density (mass per unit length) by the skein method
- [5]. SRPS EN ISO 2062 Textiles - Yarns from packages - Determination of single-end breaking force and elongation at break using constant rate of extension (CRE) tester
- [6]. EN ISO 2061 Textiles - Determination of twist in yarns - Direct counting method
- [7]ISO 1833-4 Textiles - Quantitative chemical analysis - Part 4: Mixtures of certain protein fibres with certain other fibres (method using hypochlorite)
- [8]ISO 1833-7 Textiles - Quantitative chemical analysis - Part 7: Mixtures of polyamide with certain other fibres (method using formic acid)

## LITERATURE

1. Vojislav Gligorijevic., Projecting transversely Knitted weave; LAP LAMBERT Academic Publishing (2016-04-08).
2. Vojislav Gligorijevic., Technology of Knitting Theoretical and Experimental Analysis (2016-04-08)
3. Özdil N.; Stretch and Bagging Properties of Denim Fabrics Containing Different Rates of Elastane, Fibres and Textiles in Europe, Vol. 16, No. 1, 2008, pp. 63-67.
4. Geršak J., Šajn Gorjanc D., Bukošek V.; A Study of the Relaxation Phenomena in the Fabrics Containing Elastane Yarns«, Int. J. Cloth. Sci. Technol., Vol. 17, No. 3/4, 2005, pp. 188-199.
5. Šajn Gorjanc D., Geršak J., Flajs R.; Prediction of Stress Relaxation of Fabrics with Increased Elasticity«, Tex. Res. J., Vol. 76, No. 10, 2006, pp. 742-750.
6. Gorjanc S., Bukosek V.; The Behaviour of Fabric with Elastane Yarn during Stretching, Fibres and Textiles in Eastern Europe, Vol. 16, No. 3, 2008, pp. 63-68.
7. Karba M., Geršak J., Stjepanović Z.; Study of mechanical properties of a knitwear. V: XLI Congress of the International Federation of Knitting Technologists, Zagreb, 1-4 October, 2002. Proceedings. Zagreb: Faculty of Textile Technology, 2002, pp. 122-132.
8. Karba M., Geršak J., Stjepanović Z.; The influence of knitting parameters on dimensional changes of knitted fabrics the process of relaxation, Book of proceedings of the 2<sup>nd</sup> International Textile, Clothing & Design Conference ITC&DC, October 3<sup>rd</sup> to October 6<sup>th</sup>, 2004, Dubrovnik, Zagreb: Faculty of Textile Technology, University of Zagreb, 2004, pp. 200-205.
9. Salopek I., Skenderi Z., Geršak J.; Investigation of Knitted Fabric Dimensional Characteristics = Istraživanje dimenzij- skih karakteristika pletiva, Tekstil, Vol. 56, No. 7, 2007, pp. 391-406.
10. Ben Abdesslem S., Ben Abdelkader Y., Mokhtar S., Elmarzougui S.: Influence of Elastane Consumption on Plated Plain Knitted Fabric Characteristics, Journal of Engineered Fibers and Fabrics, Vol. 4, No. 4, 2009, pp. 30-35, <http://www.jeffjournal.org>
11. Morton W. E., Hearle J. W. S.; Physical Properties of Textile Fibres, Third Edition, The Textile Institute Manchester, Manchester, 1993.
12. Munden D. L.; "The geometry and dimensional properties of plain-Knit fabrics", Journal of The Textile Institute, Vol. 50,.
13. De Jong, S., and Postle, R., An Energy Analysis of the Mechanics of Weft Knitted Fabrics by Means of Optimal Control Theory, Part II, the Plain Knitted Structure, J. Textile Inst. 68, 307 and 316 (1977).
14. Doyle, P. J., Fundamental Aspects of the Design of Knitted Fabrics, J. Textile Inst. 44, 561-578 (1953).
15. Kurbak, A., Plain-knitted Fabric Dimensions Part I, Textile Asia 29(3), 34-36, 41-44 (1998).
16. Araújo, M., Figueiro, R., and Hong, H., Modelling and Simulation of the Mechanical Behaviour of Weft-knitted Fabrics for Technical Applications, Part II: 3D Model Based on the Elastica Theory, AUTEX Res. J. 3(4), 166-172 (2003).
17. Munden, D. L., The Geometry and Dimensional Property of Plain Knitted Fabrics, J. Textile Inst. 50, T448-T471 (1959).
18. Munden, D. L., The Geometry of a Knitted Fabric in Its Relaxed Condition, Hosiery Times April, 43 (1961).
19. Kurbak, A., and Ekmen, Ö., Basic Studies for Modelling of Complex Weft Knitted Fabric Structures Part I: Creation of a Geometrical Model for Widthwise Curlings of Plain Knitted Fabrics, Textile Res. J., 78, 198-200 (2008).
20. Kyosev, Y., Angelova, Y., and Kovar, R., 3D Modelling of Plain Weft Knitted Fabrics of Compressible Yarns, World Textile Conference - 4<sup>th</sup> Autex Conference, Roubaix, France (2004).

## CONSTRUCTIONAL PREPARATION OF DRESS INSPIRED BY NATURAL TEXTURES

Andela Đurašković, Jovana Lazić, \*Tatjana Šarac, Nenad Ćirković

Faculty of Technology in Leskovac, University of Nis, Serbia

e-mail [andjeladjuraskovic000@gmail.com](mailto:andjeladjuraskovic000@gmail.com), [jovanajox@gmail.com](mailto:jovanajox@gmail.com) \*[tangerine.art83@gmail.com](mailto:tangerine.art83@gmail.com),  
[nenadcira@gmail.com](mailto:nenadcira@gmail.com),

### ABSTRACT

*Fashion has been constantly advancing by means of various innovations throughout history. However, no matter how much innovative it was and even ahead of its time with certain inventions, an inexhaustible and constant source of inspiration for many designers is nature, the diversity of its forms, shapes and textures, respectively. Each model reflects the beauty of the diversity of natural textures. The initial idea, inspiration, was found in cracks, relief surfaces, prints and various organic forms. Along with innovations and changes, the use of technology has increased. CAD (Computer-aided design) and CAM (Computer-aided manufacturing) systems reduce the time of clothing production by excluding production of trial series, whilst production and testing of trial models is done on virtual mannequins. For selected model from the collection, the basic structure, modeling, completion, grading and cut images were made using Optitex software.*

**Key words:** fashion, clothing design, technology

### INTRODUCTION

Clothing and fashion is constantly changing, because it became the object of capital and a large impact on society, people generally feel socially accepted. Strengthen the industry, capitalism is born, where the man becomes an object of manufacture, the it is treated as a mere means of production which disrupts respect to man. The clothing industry is growing, clothing loses its value, becomes expendable and easily replaceable, but it will next season become "unfashionable". Fashion is constantly advancing various innovations throughout history. However, no matter how fashion was innovative, and even ahead of its time with some inventions, inexhaustible and constant source of inspiration for many designers is the nature, and the diversity of its shape, form and texture.

Each model reflects the beauty of the diversity of textures in nature. For the basic ideas, the inspiration is found in the cracks, relief surface, prints and various organic forms. Together with innovations and changes, the use of technology has grown. CAD (Computer-aided design) and CAM (Computer-aided manufacturing) systems reduce the time of clothing production, exclude the production of trial series, and the creation and testing of trial models is done on virtual models.

For the chosen model from the collection, basic construction, modeling, completion, grading and cut images were made using the Optitex software.

### FRAGMENTAL TEXTURE IN THE NATURE - INSPIRATION FOR CONTEMPORARY CLOTHING

*"A visual observation reveals the general recognition of each material. In this sense, we are closer to those material properties we come to contact with more often. In this sense, we are closer to those materials that we are in touch more often. And it happens that with the sight of the eye we find out all the properties of some surface, shape, and that we do not have more need for touch. What we see by visual observation or touch as a certain state of the material is the texture. "[2]*

Fragmental textures, different amorphous forms, macrostructure, metamorphoses in nature were originally taken as the inspiration for creating this collection. Today, the type of topics in their collections are most often used by designers such as Iris Van Harpen and Alexander McQueen. Figure 1 shows creations of designer Iris Van Harpen



*Figure 1: Creations of designer Iris Van Harpen*

To give the construction of the model a kind of three-dimensionality, these designers used 3D printing technology. 3D printing is a modern technology for the production of three-dimensional objects. 3D printing is a generally faster, cheaper and easier solution than other 3D manufacturing technologies. As the "pioneer" among designers, Iris Van Harpen commonly uses stereolithography (SLA) methods and selective laser sintering (SLS).

In the last few years, 3D printers have become financially accessible to small and medium-sized enterprises, making the prototype shifting from heavy industry to the office environment.

## **MATERIALS AND METHODS**

### **Description of collection**

A collection of contemporary dresses is intended for women who want to look eccentric and striking. For the production of all models, several types of materials are envisioned: Polyester, Muslin, Cotton, Silk, Plastic, Silicone (to cover certain parts of the garment and details), Liqueur, Viscose Fabric. The collection consists of 10 models. Models enrich patterns and patterns that predispose styling of the form of "fragility" or "moment of decay", as well as stylization of branching of branches in nature, stylization of wing insects, etc. Colors prevail through the entire collection are usually warm earthy tones and shades of cool gray-blue tones. Drawings are made by combining techniques, gouache, watercolor, pencil. Figure 2 shows sketches of models in collection.



*Figure 2. Sketchs of the models*

## RESULTS AND DISCUSSION

The model No. 1 was selected for realization. The realized model is a dress that follows the body line, it is cut in the waist, without sleeves. The dress is adorned with a high Russian collar and the length of the dress is up to the wrists on the leg. The front part consists of two parts together with the collar, and the front part is made of the movements of the embroidery. The back part consists of four parts and has two bumps on the back. Figure 3 shows sketch of the selected mode, and figure 4 technical drawing.

Based on drawings and technical sketches, the basic construction of the dress, modeling, completion, grading and pattern image were made.



*Figure 3; Sketch of the selected model*

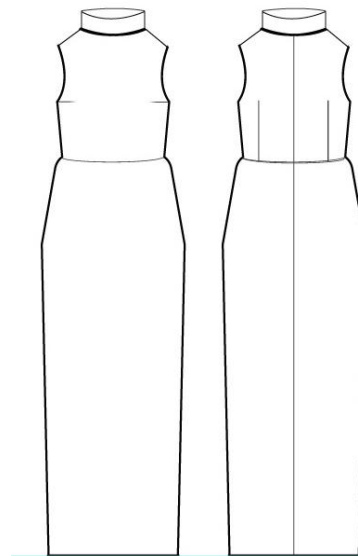

*Figure 4.: Technical sketch of the model*

### Basic construction of the dress

Design, modeling, completion, grading of cuts were made with the software Optitex, PDS version 12, while the drawing of pattern images was done using MARKER 12 software, which is part of the Optitex software package.

The basic construction of the cuts is made for size 40, the main measures are following:

Bh (body height) = 170 cm,

Cp (chest perimeter) = 92 cm,

Wp (waist perimeter) = 70 cm,

Hp (hips perimeter) = 100 cm

Calculation of auxiliary (constraint) measures is shown in Table 1.

*Table 1: Calculation of auxiliary (constraint) measures*

Auxiliary measures	Formulas for calculating auxiliary measures	Values
Depth of sleeve	$Dos = 1/10 Og + 10,5 + 1$	20,5 cm
Length of back	$Lob = 1,4 Vt - 1$	41,5 cm
Hips height	$Hh = Dl + 20$ cm	61,5 cm
Model length	$Ml = 1/2 Vt + 55$ cm	140 cm
Width of neckline	$Won = 1/20 Og + 2$	6,6 cm
Back width	$Bw = 1/8 Og + 5,5 + 1$	18 cm
Width of waistband	$Wow = 1/8 Og - 1,5 + 1,5$	11,5 cm
Chest width	$Cw = 1/4 Og - 4 + 1,5$	20,5 cm
Front height	$Fh = Dl + 1/20 Og$	46,1 cm

The basic construction of front and back cuts of woman's dress is given in Figure 5 and the collar in Figure 6. Construction of the basic cut is made in Optitex PDS 12 software Since the dress is sleeveless, the sleeves were not designed. Only the construction of the collar was made.

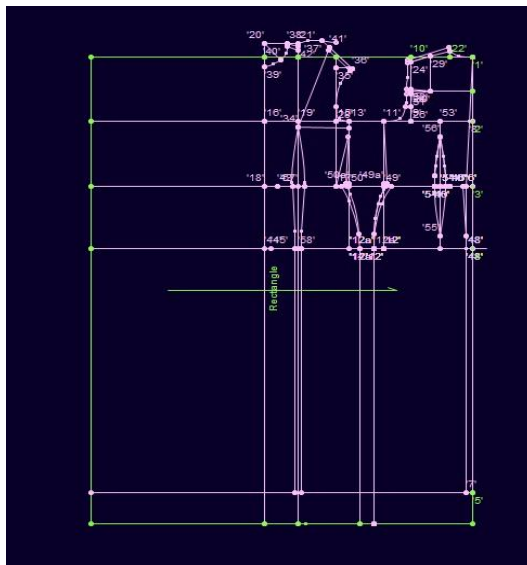

*Figure 5: Basic construction of the dress made in PDS 12*

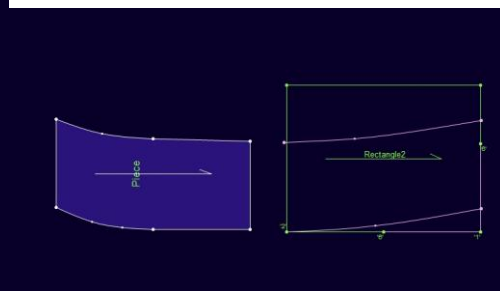

*Figure 6: Construction of the collar in PDS 12*

## Modeling the dress

Modeling (Figure 7) was done according to the sketch of the model itself and its description. The modeling process involves the relocation of seams on a construction cut. Determination of new seams by adding folds, falts, expanding and moving parts of a garment. The lower front part is cut out of one part, as well as the upper part of the dress. On the upper front part the seams have been moved to the chest area and narrow the collar. The back is also cut into the waist. The upper and lower back parts are cut out of two parts, and on the upper back part are two seams placed with length of 14 cm.

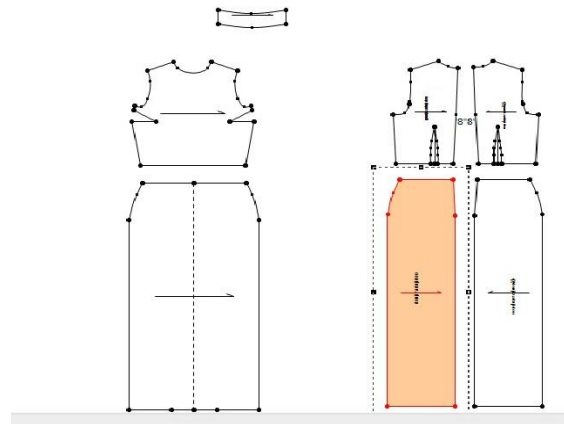

*Figure 7: Modeling of the dress*

## Completion of cut parts of the dress

After modeling, the completion of pattern parts, the seam and porch accessories, as well as the marking, were made (Figure 8). For the production of a women's dress, the following parts are required:

1. upper back part 2X
2. lower back part 2X
3. upper front part 1X
4. lower front part 1X
5. collar 2X

The seam and hem allowances should be as long as necessary to smoothly sew with the appropriate seams. For this model the seam allowances are 1 cm and for hem is 3 cm.

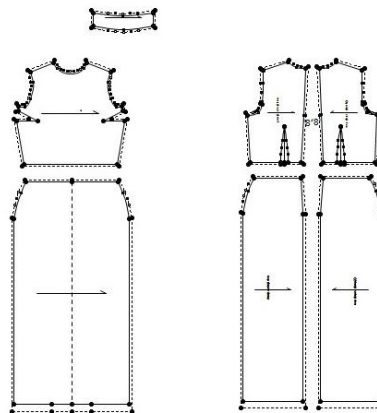

*Figure 8: Completion of cut parts of the dress*

## Grading of garments

Grading is done for two sizes (one smaller and one bigger) 38 and 42, since the basic size is 40. Grading of cut parts of the dress is shown in figure 9

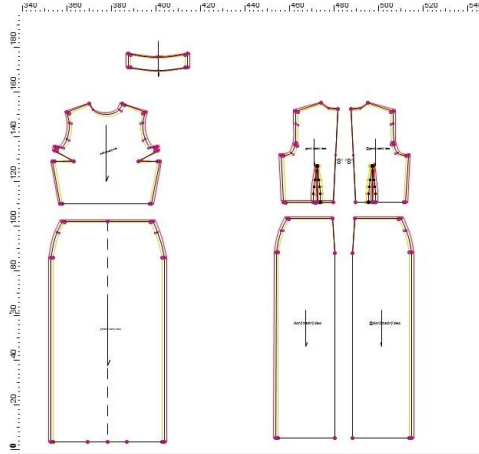

Figure 9: Grading cutting parts of garments

## Making the pattern image

The pattern image is a set of all the cut parts of a single item, fitted to a certain type of paper, technical textiles, knits, fabrics, etc. The purpose of cutting images is to determine the correct paths, cuts, and to ensure optimum utilization of the materials from which the garments are made. In order to achieve as much rational material as possible, the cutting parts are often placed in one direction and the other in the other direction. In order to get the left and right sides of a cut part, they lie down so that one part is a reflection of the other like in a mirror. The direction of the base must be comparable to the linear length of line. Figure 10 shows pattern image for the dress and sizes 38, 40 and 42. The width of the image is 115 cm, length 4,71 m, and the utilization of the material is 85.85%.

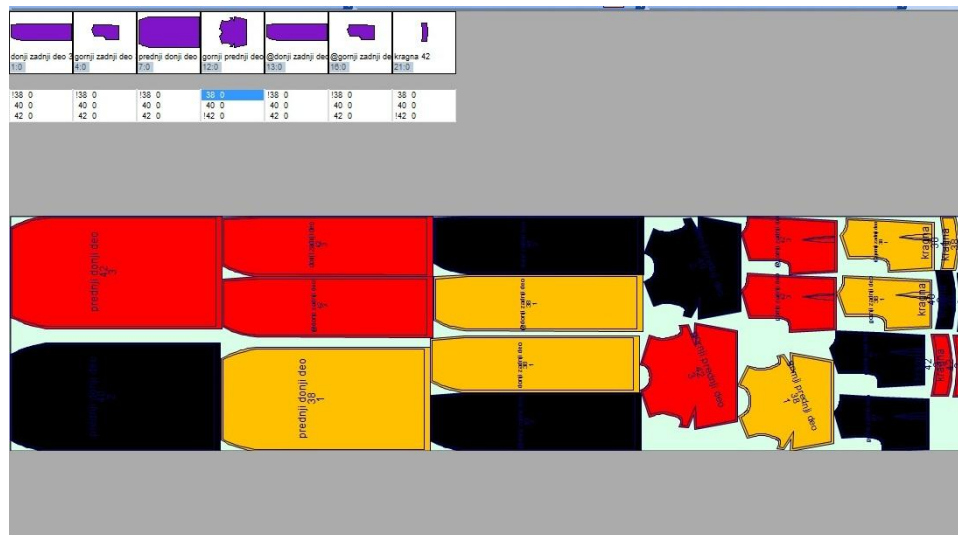

Figure 10: Pattern image for sizes 38,40,42



Cutting pattern (Figure 12.) - the size 38,40,42, the number of layers of material 24, the width of marker 115 cm, length 4m 71.cm cutting pattern, cutting pattern and utilization is 85.85%.

## CONCLUSION

The application of several types of technologies in fashion enabled its development. Today, the clothes no longer meet only the classical physiological needs, but some pieces are also considered as works of art. Designers are massively experimenting with a variety of materials and techniques. The same can be said for the application of technologies in mass production and application of structural production segments. Designer Iris Van Harpen uses the most modern 3D printing technology in her work, making her models and details of models gain unusual amorphous shapes that at the same time give a futuristic impression in her collections. In the introductory part, the inspiration for the creation of this collection is explained in more detail, while in the experimental part includes all the procedures for constructing one selected model in the Optitex program.

## REFERENCES

- [1]Ujević D.,Rogale D., Hrastinski M.,Tehnike konsturiranja i modelovanja odjeće, Tekstilno-Tehnološki fakultet, Zagreb,2010.
- [2]Bogdanovic K.,Burić B., Teorija forme ,Beograd, 1991.
- [3]Optiteks,voidič kroz program, DIGITALIZACIJA,PDS,GRADIRANJE,MARK
- [4]<https://optitex.com/>
- [5]Hrastinski M., Gradiranje i računarna konstrukcija odjeće, Zagreb 2000.
- [6]<http://www.irisvanherpen.com/>
- [7][https://en.wikipedia.org/wiki/3D\\_printing](https://en.wikipedia.org/wiki/3D_printing)

## INFLUENCE OF THE RAW MATERIAL COMPOSITION OF KNITWEAR ON COMFORT CLOTHES

Marija Pešić, Vasilije Petrović, Danka Joksimović, Anita Milosavljević, Stanislava Sindelić  
Technical Faculty "Mihajlo Pupin", Zrenjanin, University of Novi Sad

### Abstract

*Clothing comfort is an important factor in the stage where people make their clothing selections. Thermophysiological comfort is directly related to physiological processes of human body and is the result of the balanced process of heat exchange between the human body, the clothing system and the environment. The measuring values that reflect the ability to assess the heat exchange of the human body with the environment is related of human perceptions of comfort, are thermal resistance or insulation  $R_{ct}$  and coefficient of thermal conductivity  $\lambda$ . The measurements in this paper was carried out on commercially 1x1 RIB knitted fabrics used for the production of next -to-skin shirts. The one group of samples are made from 100% cotton yarn and another with 96% cotton and 4% lycra. It is noticed that knitted material composition affected the change in heat resistance and thermal conductivity.*

**Key words:** thermal comfort, thermal insulation, coefficient of thermal conductivity, rib knitwear

### INTRODUCTION

Technological and scientific development enabled the production of high quality textile products. To successfully participate in the free market area, many manufacturers today invest significant amount of resources in researching and developing products tailored to the needs of man. The focus of these research is often directed towards the fulfillment and individual demands of individuals. Customers' requests are guided according to their desire to feel comfortable, relaxed, attractive, etc.

Clothing comfort is an important factor in the stage where people make their clothing selections [1]. It is also an important factor in business garments, since they are intended to be worn through the whole day in different environmental conditions. The garments can be seen as a heat exchange layer between the body and its environment, and contemporary requirements regarding clothing comfort are much higher than in the past. Thermophysiological comfort is directly related to physiological processes of human body and is the result of the balanced process of heat exchange between the human body, the clothing system and the environment [2].

The center of the body warmth control is located in the brain and regulates warmth transport by blood flow through blood vessels, capillaries to the skin surface and sweat secretion. To control heat exchange, it is possible to protect the body against overheating as well as against undercooling. In this case physical regulation controls heat loss, and chemical regulation controls thermal processes. Body is heated by thermal energy which is produced from the energy generated due to the decomposition of energy - rich carbohydrate molecules and fats. Heat transfer can occur by radiation  $R$ , convection  $C$ , conduction  $K$ , evaporation  $E$  and respiration  $E_{res}$  Slika1 [3].

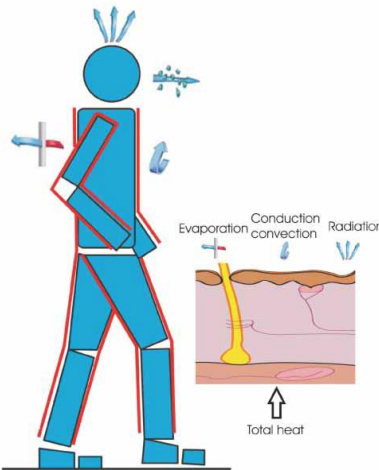

Figure 1. Heat transfer of human body

Equation of heat balance includes three terms: those for heat generation in the body, heat transfer and heat accumulation. The degree of metabolic energy of body  $M$  produces energy, enabling the body to the mechanical work  $W$ , and the heat remainder is released as heat (i.e.  $M - W$ ). To analyze heat exchange between body and environment, specific production procedures and heat exchange for the human body are used. Fanger provides the following relation to meet the conduction for thermal comfort [4].

$$H - E_{dif} - E_{sw} - E_{res} - C_{res} = R + C$$

where all terms contain the unit  $W_{m^{-2}}$  and  $H$  is metabolic heat production,  $E_{dif}$  is external mechanical work or evaporation by moisture diffusion through the skin,  $E_{sw}$  is heat loss by sweat evaporation,  $E_{res}$  is heat loss by latent respiration,  $C_{res}$  is heat loss by dry respiration over the unit area.

ASHRAE gives the following equation of heat balance [4]:

$$M - W = Q_{sk} + Q_{res} = (C + R + E_{sk}) + (C_{res} + E_{res})$$

where all terms contain the unit  $W_{m^{-2}}$ .  $M$  is metabolic heat production,  $W$  is mechanical work consumption,  $Q_{sk}$  is total rate of heat loss by radiation from the skin,  $C$  is the rate of heat loss by convection from the skin,  $R$  is the rate of heat loss by radiation from the skin,  $E_{sk}$  is the total rate of heat loss by evaporation and  $E_{res}$  is total rate of heat loss by evaporation from respiration.

The measuring values that reflect the ability to assess the heat exchange of the human body with the environment, related to human perceptions of comfort, are thermal resistance or insulation  $R_{ct}$  and coefficient of thermal conductivity  $\lambda$ . [5]

## MATERIALS AND METHODS

The investigation was carried out using the knitted fabrics that are commercially used for the production of next-to-skin-wear. This product is worn as the first layer that is in contact with human skin. The knitting structure used in this paper is 1x1 RIB produced with two different fiber compositions. First type of samples are made from 100% cotton yarn, and second type of samples are made from 96% cotton and 4% Lycra. Also, there are two types of linear density for cotton yarn. Used linear densities in this paper are 20 tex and 13 tex. The fabrics were finished according to the recipe that includes optical bleaching and softening. The fabric designation and description are shown in Table 1.

*Table 1. Basic characteristics of analyzed knitwear's samples*

Samples	B <sub>1</sub>	B <sub>2</sub>	B <sub>3</sub>	B <sub>4</sub>
Structure	1x1RIB	1x1RIB	1x1 RIB	1x1 RIB
Fiber composition	100% CO	100% CO	96% CO / 4% LY	96% CO / 4% LY
Linear density (tex/dtex)	20	13	20/4,4	13/4,4
Twists (m-1)	565	693	565 / -	693/ -
Finishing	bleached	bleached	bleached	bleached

## RESULTS AND DISSCUSSION

The KES FB 7 - Thermo Labo II measuring device was used to test the thermal characteristics of knitted samples[5].



Fig.1. Kes FB 7 - Thermo Labo II device

Thermal resistance ( $R_{ct}$ ) represents thermal insulation of the material and it is inversely proportional to the thermal conductivity, which is shown by the formula.

$$R_{ct} = \frac{h}{\lambda} (m^2 K/W)$$

In dry materials or in materials that contain very small amounts of water, it depends directly on the thickness of the material ( $h$ ) and the conductivity of fibers ( $\lambda$ )[5].

### Determination of the thermal conductivity coefficient $\lambda$

Thermal conductivity is one of the essential criteria of the insulation capacities of the material and its measurement is based on the transfer of heat from the warmer to the cooler part, i.e. on the principles of heat conduction.

To measure the thermal conductivity, a sample of 50x50 mm is required, which is placed on a measuring body with VT water. When the metering body of BT achieves the desired temperature of 35 °C, which simulates the skin temperature of the human body, it is placed on a pattern that is face-up on the VT body of measurement. The value of the heat flow  $\phi$  is read from the digital display.

The obtained heat flow values are further used to calculate the heat conductivity constant, i.e., the coefficient of thermal conductivity  $\lambda$ . the thermal conductivity coefficient is calculated according to the following expression[5]:

$$\lambda = \frac{\phi \cdot h}{A \cdot (T_{BT} - T_a)} \quad i.e. \lambda = \frac{\phi \cdot h}{A \cdot \Delta T}$$

Wherein:

$\lambda$  - coefficient of thermal conductivity [ $W/mK$ ]

A - surface of BT plate [ $0,0025 \text{ m}^2$ ]

h - fabric thickness [m]

$T_{BT}$ - temperature of BT plate [K]

$T_a$ - temperature of the environment [K]

$\phi$  - thermal flow [W]

Experimentally obtained results of heat resistance RCT and coefficient of thermal conductivity are shown in Figure 3.

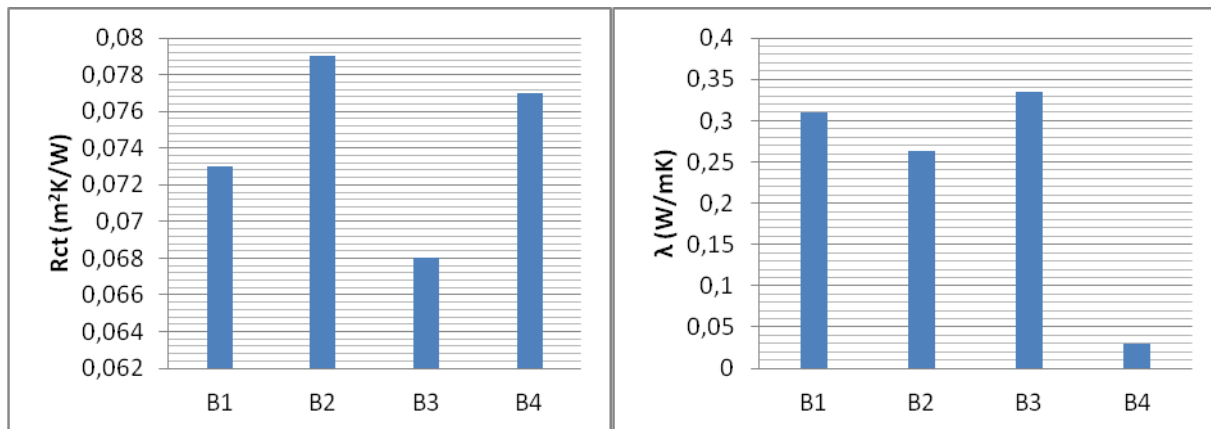

Figure 3; a) Graphic representation of mean value of thermal isolation RCT  
 b) Graphic representation of mean value of coefficient of thermal conductivity  $\lambda$

From Figure 3a. it can be seen that the values of thermal insulation Rct of bleached samples of 1x1 reabsorbed knitted fabrics of 100% cotton rises with the use of finer knitting yarns and amount to 0.079 m²K/W, while with more coarse yarn mean value of measured parameter is 0.073 m²K/W. The lower values of thermal insulation occur in the case of knitted fabrics that have a lycra in their composition. Thermal insulation in samples with a lycra made of coarse yarn is 0.068 m²K/W, and for samples with a finer cotton yarn in its composition 0.077 m²K/W.

From Figure 3b. it can be seen that the values of the coefficient of thermal conductivity  $\lambda$  of bleached samples of 1x1 of reabsorbed knitted fabrics of 100% cotton decrease with the use of finer knitting yarns and amount to 0.263 W/mK while with more coarse yarn mean value of measured parameter is 0,310 W/mK. The lower values of the thermal conductivity coefficient  $\lambda$  occur in the case of knitted fabrics containing 4% of the lycra. Thermal insulation of the sample with a lyre made of coarse yarn is 0.335 W / mK to samples with a finer cotton press in its composition 0.297 W / mK.

## CONCLUSION

Knitted fabric have a structure which offers stretch ability and elasticity of knitwear. This advantages make knitwear comfortable and fit well to body contours, providing transpiration as well. It can be concluded that the raw materials of the yarn, from which the ribbed knitted fabric has been made, have a significant influence on the thermal insulation and on the coefficient of thermal conductivity. Knitted fabrics that show the best thermal insulation are knitted fabrics that contain a lycra. Because of its elastic abilities, the lycra contributes to a more compact structure of knitted fabrics and thus to better thermal insulation. In this case, knitted fabrics made of thicker cotton yarn 20 tex- and lycra are recommended for colder days when warm clothing is required. And the knitted fabrics made of fine cotton yarn are recommended for warm days.

## LITERATURE

- [1] M. Pesic, V. Petrovic, J. Stepanovic, C. Besic, The analysis of dimensional stability of 1x1 rib co and co/ly knittwear, *Industria textila*, Vol. 59, No.4, 2018., ISSN 1222-5347, pages 293-297.
- [2]B. Mijović, I. Salopek Čubrić, Z. Skenderi. "measurement of thermal parameters of skin-fabric environment." *Periodicum biologorum*, 112, no. 1 (2010): 69-73.
- [3]E., Utkun. "Comfort - related properties of woven fabrics produced from Dri-release yarns." *Industria Textila* 65, no. 5 (2014): 241-246.
- [4]O., Fanger P. "Thermal comfort." (Danish Technical press) 1970.
- [5]*Operating Instruction KES-F7: Manual for KES 7 Thermo Labo II, Precise and Prompt Thermal Prosperity Measurement Instrument*, Kyoto: Kato Tech Co. Ltd, 1998.
- [6] V. M. Petrović – Tehnologija pletenja – Univerziteti udžbenik, Tehnički fakultet “Mihajlo Pupin” Zrenjanin, 2000.
- [7] V. Lasic – Vezovi i pletiva – Zagreb (1998)
- [8]Banu Uygun Nergis, Cevza Candan - Performance of Rib Structures from Bouclé Yarns - FIBRES & TEXTILES in Eastern Europe April / June 2007, Vol. 15,
- [9] A., Lotens W. "Heat transfer from humans wearing clothing." PhD Thesis, Delft University of Technology 1993.

**Acknowledgment:** This paper is a part of the research project No. TR – 34020, financed by the Ministry of Education, Science and Technological Development of the Republic of Serbia. We thank the Ministry for financial assistance.

## ANALYSIS OF THE IMPACT OF FABRIC PARAMETER ON DEFORMATION CHARACTERISTICS OF STITCH

Anita Milosavljević, V. Petrovic, D. Trajković, D. Joksimovic, M. Pesic, S. Sindelic

\*Faculty Of Technology Leskovac, University Of Nis - The Scholarship Holder Of The Ministry

\*Technical Faculty "Mihajlo Pupin", Zrenjanin,

Đure Đakovića Bb, 23000 Zrenjanin

mail: [anita.milosavljevic@hotmail.com](mailto:anita.milosavljevic@hotmail.com)

### ABSTRACT

*The work analyzes the parameters of Belissima fabrics in which the sewing burst emerged. Woven fabrics with all technological parameters were observed. Then they were named for the impact analysis of fabric chain points by using different needle numbers and long thread lengths. The aim of the paper is to investigate which long thread length and needle track will lead us to the strongest stitch on the fabric, the smallest fabric damage and the best quality. In order to achieve the most reliable results and improvements in the quality of the stitch, not damaging the fabric and the product itself, realistic patterns of fabrics used in the manufacture of wearing articles in the production are examined. The elastin-containing material is tested to determine the influence of fabrics for the strength of stitches.*

**Key words:** Stitches, fabric, needle pins, longitudinal mass, thread, stitches strength.

### 1. INTRODUCTION

During wear, the clothes are exposed to stretches depending on the type of movement of the body, cut, the method of making the garment and the material used. Excessive stretching can cause damage to clothing. Such damage usually occurs on clothing stitches, but also on the material of the garment. In the process of producing clothes, there are numerous parameters that affect the quality of stitches. These include, among other things, the type of material, fineness of threads, types of sewing points and their density. In order to obtain very attractive garments, which satisfy the comfort of wearing and the possibility of smooth movement of the body and its parts, then a nice "drop" of clothes and easy maintenance, the fabric manufacturers produced a wide range of elastic fabrics from a variety of yarns. The appropriate point type must also be determined, the optimum sticking density, the shape of the needle tip, the best way of transporting the sewing material, the needle sticking speed...

### 2. THE INFLUENCE OF THE TYPE OF FABRICS ON THE STRENGTH OF THE STITCHES

Textile fibers begin to determine the strength of the fabric. Textile fibers are very different in linear load behavior. Fibers similar to the raw material composition have different behavior in the field of force. Furthermore, the properties and appearance of the fabric depend on the type of yarn, its fineness, the strength and direction of the twisting of the threads, as well as the density of the threads in the fabric on the basis and per pot.

The hardness and the higher the strength of the fabric is achieved by a highly spun yarn; The poorly spun yarn gives the fabric softness and moisture and sweat absorption, but this fabric is both less strong and less resistant when used. Table 2 shows the extent to which the yarn affects the strength, the appearance and the opacity of the fabric.

**Table 1.** *The influence of the type of yarn on the strength and appearance of the fabric*

Characteristics of yarn	Impact on strength	Influence on the fabric
Yarn from filaments	unfavorable	smooth and strong fabric, high gloss, uniform
Fiber yarn	favorable	soft and lightweight fabric, rugged felt, no shine
Slightly twisted	unfavorable	soft and lightweight fabric, ruffled felt
Very curved	favorable	hard and strong fabric, stable shape
Soft yarn	unfavorable	soft and pleasant fabric, good drop
Hard yarn	favorable	strong strong fabric

The type of interlacing significantly affects the properties and appearance of fabrics. Higher interference density, the more frequent passage of the thread from the face of the fabric to the back and vice versa, gives the fabric greater resistance and strength. The largest volume has a cloth interlace, then twist and twist the interlace.

The force required to overcome friction between the base and the weft is defined as the shear strength of the fabric on the shear. The resistance against shearing the composition of the threads in the fabric is greater than the fabric of the weft, which is a more uniform fineness of the base and the thread, and the more intensive connection is chosen. In contrast, the fabric of the low density of the threads, the very different finishes of the base and the footprints are significantly more susceptible to shearing. The shear strength of the fabric, depending on the density of the thread, has a linear dependence, since the denser setting of the binding points per unit area increases the strength of the fabric. However, the circumstances conditioned by the technological process of sewing, for example, a small width of the seams or various cuts, can greatly affect the shear strength of the fabric. If a shear of 1 mm in a thread and in a fabric requires force between 60 N and 80 N, then the shear strength of the woolen garments will be satisfactory, but in some clothing items (tightly knit trousers) can result in frequent damage. Woven fabrics whose shear strength is less than 60 N are not suitable for making clothes.

### 3. EXPERIMENTAL PART

We analyzed the fabric used for Belissima clothing cases where the sewing problem appeared. Chain points were named for the analysis by using different needle tracks and long thread lengths. The aim of the work is to investigate which long end of the needle and the number of needles will lead us to the strongest seams and which seams are best for the fabric tested, ie its minimal damage during the construction.

### 4. CHARACTERISTICS OF THE MATERIAL BEING EXAMINED

For the fabrication of seam samples for testing, the selected material is made of a mixture of polyester and cotton (67:33). This material is used in regular production at the Belissima Company and there have been damage to sewing.



The samples were prepared and the quality of the seams for the material that is part of the Belissima production program was tested, but no additional materials were examined, but only the quality of the seams on that material, that is, the grain and chain points and the longitudinal mass of the end. Figure 1 shows the used fabric for making samples.



*Picture 1. Display of the used fabric from which sewing samples are tested*

## 5. CHARACTERISTICS OF THE STITCHES USED FOR TESTING

*Table 2: Values of the examined sitch I - longitudinal thread Tex 10*

QUALITY CONTROL:		
No.	Rated quality characteristic (unit of measure)	Value obtained
1.	Raw material composition (%) POLYESTER	100
2.	Determination of longitudinal mass (tex)	20 (10x2)

*Table 3: Values of the examined sitch II - the longitudinal end of the Tex 8 thread*

QUALITY CONTROL:		
No.	Rated quality characteristic (unit of measure)	Value obtained
1.	Raw material composition (%) POLYESTER	100
2.	Determination of longitudinal mass (tex)	16 (8x2)

## 6. PREPARATION OF TEST SAMPLES

For the method of testing the breaking force and the interrupted elongation of the seam weld, samples of fabric 70 mm in width and 150 mm in height are required. Two or more samples are placed one above the other face on the face or in some other order and then extend through the appropriate machine. The final shape of the sample is obtained when the closing edge of the fabric is close to the seam, ensuring that the seam is not damaged so that the length of the seam remains 50 mm. After that, the thread that remained on the edge of the fabric near the seam should be adhered to the fabric so that the seam will not be paired. Prior to testing the sample, it is necessary to mark the line indicating the exact distance of the seam to the clamp of the dynamometer in order to obtain the most accurate results. The distance from the seam line is 100 mm.

The samples were stitched with needles of numbers 80 and 90. The sewing thread of the longitudinal mass 20 tex and 16 tex was used for sewing the samples needed for interrupting the stitches. Some fabrics are welded with stitching type 1.01.03 and type 301. The point density applied was 4 cm<sup>-1</sup>. The stitches were prepared by sewing the stithes both in the direction of the base and in the direction of the weft. The stitches samples represented the real seams used to make pants that were analyzed. The strength of the stitch on the side of the trousers was tested both on the basis and on the course. Seamed chain stitches were examined. In doing so, he wanted to investigate which is the number of pins and the longitudinal end of the end is better.

## 7. OBTAINED RESULTS OF THE EXAMINATION

In order to achieve a more reliable overview of the current state of strength and quality of the stitches after breaking all the stitches on the dynamometer, the analysis of the obtained results is approached. For each stitch, three samples were made. The individual tearing of these stiches was done, then the results were processed and the mean values of the individual measurements of the same type of samples were given. In this way, they wanted to come up with recommendations for getting better quality and durable sewing garments that the company manufactures, or for the model used to examine the stiches. The mean values of the breaking force and the interrupted elongation are given below.

### 7.1. Tabular display of the results achieved

In table 4. the obtained results of the mean values of the breaking force and the interruption of the elongation for material I, where the change in the ending end of the end and the changes and needle numbers have been performed,

**Table 4:** Review of the obtained results of the interrupted force and interruption of elongation on the material.

Longitudinal mass of the end	Needle number	Direction	Point type	Tear splash [N]	Elongation [mm]
<b>20 tex</b>	80	Basis	Chain	2551	24,5
	90	Basis	Chain	2708,33	26,73
	80	Weft	Chain	172,33	18,55
	90	Weft	Chain	171	18,51
	80	Basis	Grains	2140,33	23,84
	90	Basis	Grains	2336	19,6
	80	Weft	Grains	222	21,85
	80	Weft	Grains	213	22,84
<b>16 tex</b>	80	Basis	Chain	2675,66	26,49
	90	Basis	Chain	2695	26,88
	80	Weft	Chain	156,33	17,75
	90	Weft	Chain	140,33	17,41
	80	Basis	Grains	2211,33	24
	90	Basis	Grains	2207	21,72
	80	Weft	Grains	209	23,65
	90	Weft	Grains	218	22,35

## 7.2. View and compare results on histograms

In the continuation of the histogram work, the mean values of the stitches samples are shown. The highest sewing strengths are shown when changing the needle number 80 and 90 to the longitudinal weight of the end 20 tex and 16 tex, as well as the greatest elongation occurring during these changes, as well as changes in the direction of the base and the foot and the sewing with a grain and chain point.

### 7.2.1. Histogram display of intermittent force of the seam and elongation by the finished thread length of 20 tex

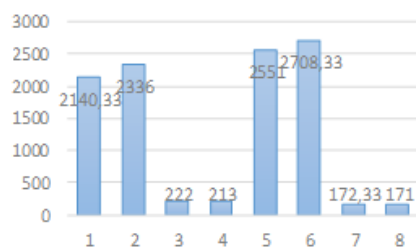

Picture 2.

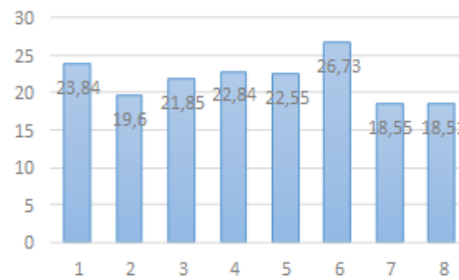

Picture 3.

**Picture 2.** the breaking severity of the stitches of the stitched longitudinal masses of the end of 20 tex and the needles of the needles 80 and 90 is shown.

**Picture 3.** shows the obtained elongations in mm in seams produced by a longitudinal mass of the end 20 tex.

According to the table shown by all the results and comparing these histograms, we can see that the results show that the number of pins 90 when applying the finite finite 20 tex in the direction of the base, and the chain point, has led to an exceptional strength of 2708.33N and the achieved elongation is 26.73mm.

A discrepancy occurred with the needle number 80 where the inadequate needle number has led to damage, and the weakest strength and elongation is 171N and the elongation is 18.51mm.

### 7.2.2. Histogram display of intermittent force of the seam and elongation made by a long end texte of 16 tex

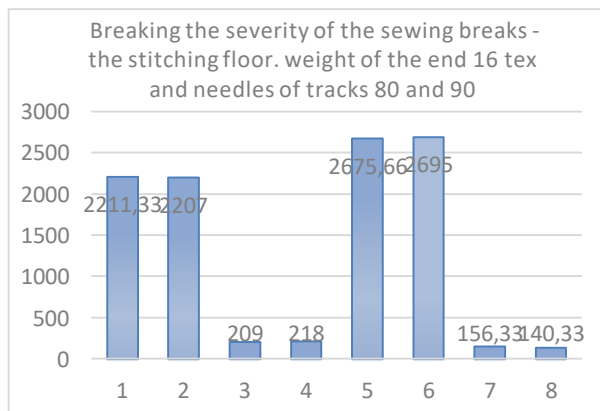

Picture 4.

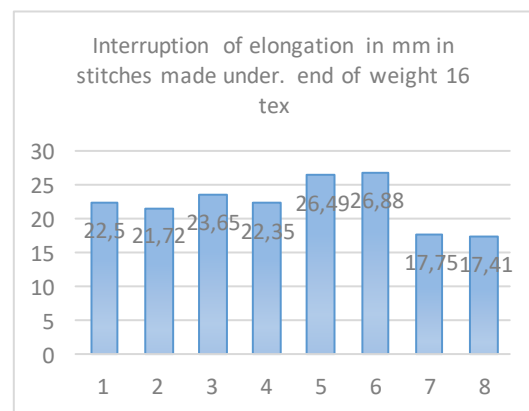

Picture 5.

**Picture 4.** the breaking severity of the seams stretched with the longitudinal teeth of the end 16 tex and the needles of the needles 80 and 90 is shown.

**Picture 5.** shows the obtained elongation in mm in seams produced by a longitudinal mass of the end 16 tex.

According to these results, we can see that the application of the end of the longitudinal mass 16 tex in the direction of the base, and the chain point, led in this case to an extraordinary strength. The strength is 2695.66 N and the achieved elongation is 26.49 mm, however, the larger elongation is achieved at the needle number 90 and is 26.88 mm. The minimum strength and elongation at this longitudinal end of the stitch is at the track number 90 in the direction of the path where the damage was sustained, and the weakest strength and elongation is 140.33N and the elongation is 17.41mm.

## 8. CONCLUSION

According to the obtained results, it can be more precisely to conclude where the load causes damage and bursting of stitch on the test material as well as what are all the causes thereof. By analyzing the obtained results in this paper, the application of the end of the larger longitudinal mass and the chain bar on the material on which the damage occurred resulted in the greatest breaking strength and interruptions of the stitches and its smallest damage.

The chain point has great elasticity which makes the stitches more durable in both the base and the direction of the trunk when combined with the corresponding longitudinal end of the end and the needle pin, which makes it possible to recommend a chain stitch for fabric fabrication, but with a larger long thread along with the change and adjustment numere igala. This is indicated by better results achieved by testing.

## 9. LITERATURE

- [1] A. Kunštek, B. Knez: Damage to seams on clothes, *Textile - Zagreb*, 35 (1986) 6, 389-402
- [2] U. Schmid, J. Mecheels: Kräfte an Textilien und Nähte der Kleidung in Abhängigkeit von Körperbewegungen und Kleidungsschnitt, *Bekleidung + Wäsche*, 33 (1981) 2, 77-82
- [3] В. Ф. Шаньгина: Структурная схема показателей качества соединений деталей одежды, *Технология легкой промышленности - Москва*, 26 (1983) 2, 113-117
- [4] Е. Б. Коблякова: Структурная схема показателей определяющих уровень качества одежды, *Швейная промышленность - Москва*, (1976) 2, 10-11, (1976) 3, 21-24
- [5] D. Rogale. D. Ujević, S. F. Rogale. M. Hrastinski: *Procesi proizvodnje odjeće*, Zagreb, Tekstilno - tehnološki fakultet Sveučilišta u Zagrebu, 2011

**Acknowledgment:** This paper is a part of the research project No. TR – 34020, financed by the Ministry of Education, Science and Technological Development of the Republic of Serbia. We thank the Ministry for financial assistance.

## DESIGN OF WOMEN'S CAPE AND MODELING WITH APPLIED ELEMENTS OF JACKET

Maja Jankoska\*

University "Ss. Cyril and Methodius", Faculty of Technology and Metallurgy,  
Department of Textile, 1000 Skopje, North Macedonia  
e-mail: maja@tmf.ukim.edu.mk

### ABSTRACT

*The aim of this paper is construction of the basic pattern of women's cape and modeling with applied elements of women's jacket. The experimental part including gathering major or standard measurements on the basis of which auxiliary measurements were calculated. The above measurements formed the basis for designing the basic shape of women's cape. The basic cape pattern was used for modeling cape with combination elements of women jacket. On the constructed basic pattern of the front and back part of a cape modeling procedures were applied for the purpose of developing the finishing pattern of a cape.*

**Keywords:** design, pattern making, modeling, women's cape, women's jacket

### INTRODUCTION

Clothing production was originally the responsibility of women. After the advent of form-fitting clothing in the thirteenth century, the responsibility expanded to include professional tailors and dressmakers. From the mid-fourteenth century, tailors authored published works on methods for cutting and constructing clothing.

The consumer is demanding more variety and personalization in apparel products. Personalization includes creating clothing that not only takes into account of variations in size, but also variations of the body shape itself. The traditional grading method is the current standard sizing system in the apparel industry (Cho Y. *et al.*, 2006). "Dress like a boss without spending like one", this saying is appropriate for the ones fancying casual jackets. These casual jackets come at an affordable price and aims at putting the wearer at maximum ease. Casual jackets are suitable for several occasions and can also be used as everyday wear. By competing through development capability and the concept of a development strategy a new product can be developed. They mainly focused on the engineering process that lies behind new products, the integration of marketing, manufacturing, the role of senior management in guiding and leading the effort (Wheelwright S.C. *et al.*, 1992). The fundamental relationships underlying the incorporation of a user orientation into the NPD process are examined. It is based on terms of enhancing collaborative new product development, improving idea generation, producing superior products or service solutions and facilitating product appropriateness and adoption (Veryzer R.W. *et al.*, 2005). The four types of involvement are consumption involvement, advertising involvement, purchase decision involvement and product involvement (O'Cass A., 2000). The main issues in fashion marketing are studied by directing distribution of a series of high-volume outlets in urban centers typically close to where people live and work businesses can make dramatic savings in fulfillment costs (Hines T. *et al.*, 2007). The consumption of luxury products by the generation Y groups are studied on the following perspectives: the influence of brand consciousness on consumption behaviors in terms on consumption motivations, the influence of self related personality traits on their brand consciousness, purchase intention, and brand loyalty (Giovannini S. *et al.*, 2015). Integrated human actions and complex socioeconomic themes, into the process of new product development to adapt its design to various competitive market.

The main phases are as follows, theme generation, product design and detail engineering, product and process development and evaluation, product and market initiation (Lu J. *et al.*, 2011). Professional fashion models are thought to exemplify bodily perfection and become symbols of ideal beauty for the general public (Sung K.S., 2004). By taking a leading part in popular culture, professional fashion models are mediators between fashion and the public; as such they influence the public and become objects of envy (Kim M.H. *et al.*, 2008). Moreover, the fact that a tall stature and thin body are necessary conditions for modeling, requiring continual attention by designers and individual models, cannot be overlooked (Joung E.A. *et al.*, 2010).

This paper presents construction of basic pattern of women`s cape and modeling with applied of women's jacket elements.

## EXPERIMENTAL PART

In the experimental part were determined and calculated measures necessary for the construction of the basic pattern woman cape was determined. On the constructed base of the front and back pieces, the modeling procedures are applied for the purpose of the development of the finished pattern. The front part of the cape is made of four pieces, a shawl collar and a closing by one button in the front which is on the hips line. At the front there are openings for arms. Back part of cape is made of two pieces.

Figure 1 shown the technical sketch of women`s cape.

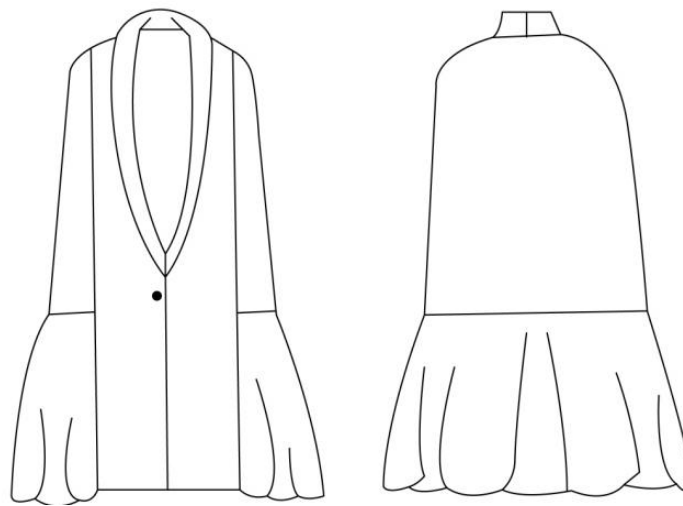

*Figure 1: Technical sketch of women`s cape*

For the construction of the basic model cape requires main or standard measures, and their values are used to calculate the auxiliary or structural measures. Table 1 shows the main and structural measures.

*Table 1: Main and construction measures of women's cape*

<b>Main measures</b>	
Body height, BH	164 cm
Bust, B	88 cm
Waist, W	66 cm
Hip, H	96 cm
<b>Construction measures</b>	
Neckline Width, NW	$1/20 B + 2 \text{ cm} = 6,4 \text{ cm}$
Back Width, BW	$2/10 B - 1 \text{ cm} + 1,8 \text{ cm} = 18,4 \text{ cm}$
Front Width, FW	$2/10 B + 0,25 \text{ cm} + 2,15 \text{ cm} = 20 \text{ cm}$
Armhole Width, AW	$1/10 B + 1 \text{ cm} + 3 \text{ cm} = 12,8 \text{ cm}$
Armhole Depth, AD	$1/8 BH + 1,5 \text{ cm} = 22 \text{ cm}$
Length Back, LB	$1/4 BH - 1 \text{ cm} = 40 \text{ cm}$
Center Back Neck, CBN	$5/8 BH - 2,5 \text{ cm} = 100 \text{ cm}$
Depth Hips, DH	$LB + 21,5 \text{ cm} = 61,5 \text{ cm}$
Height of the Front, HF	$LB + 4 \text{ cm} = 44 \text{ cm}$

### **Design of basic model of cape**

The design of the front and back parts of the basic cape model is made according to the values set out in Table 1 as well as according to the established construction rules, [11], and design is given in Figure 2.

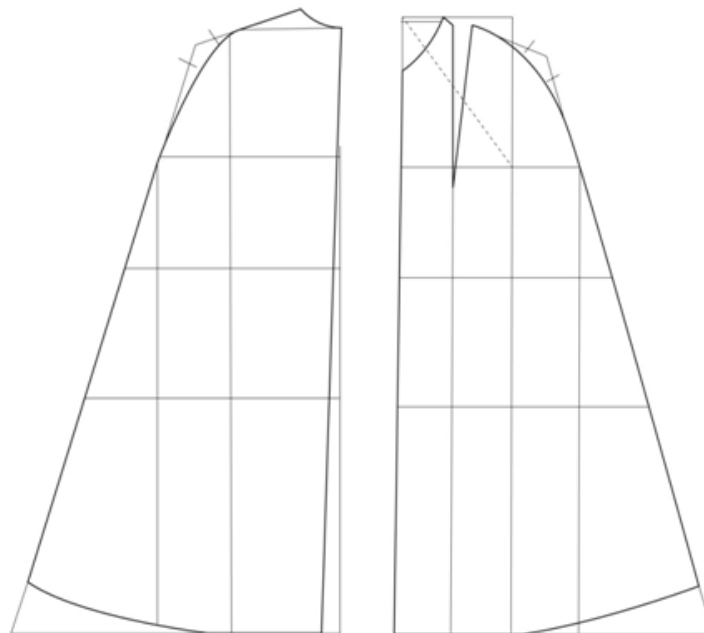

*Figure 2: Design of basic model women's cape, [11]*

### Preparation of the basic model for modeling cape

Figure 3 shows the front and back part of the cape prepared for modeling.

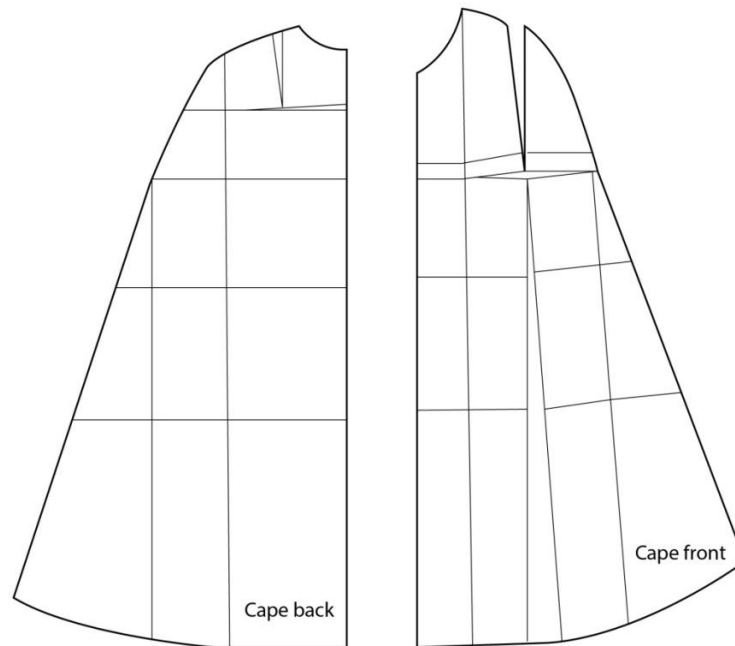

Figure 3: Prepared basic pieces of cape for modeling (front and back pieces)

The front part of the cape is extended by 5 cm in the lower part. The back part was expanded on the shoulder line by 1 cm and the center back up was also raised for 1 cm.

### Modeling the front and back part of model women`s cape

#### Modeling of front part:

The waist line is 2 cm above (points 23 ÷ 32), 2 cm hook attachment (32 ÷ 33 and 34 ÷ 35) and 0.5 cm length extension on the front of the cape (24 ÷ 34). The vertical line connects points 33 and 35. The extension of neckline is 0.5 cm to the right (29 ÷ 37). Between points 37 ÷ 38 are added 2 cm. The line flip-off with connecting point 36 ÷ 38 is drawn up and the line extends in that direction. Distance between points 38 to 39 is 5 cm, and from point 39 ÷ 40 is 10 cm. From point 41 is drawn an arrow from the center point 37. Distance between points 41 ÷ 42 is 3 cm and 42 ÷ 43 is 2.5 cm. For sketching the back centerline collar (43 ÷ 44) the vertical angle of the point 29 + 0.5 cm to the left and the point 43 is drawn. From the point 43 the bottom edge of the collar is formed, so that the rounded line passes through the points 37, (Figure 4).

The width of the collar on the back is 8 cm (43 ÷ 44). From the point 43 the horizontal line is drawn at a vertical angle to the left and is indicated by point 44. From the point 44 the curved line is drawn through the points 40 and 36. Distance between the points 31 to 45 is 5 cm and the point 45 is connected to point 1, (Figure 4).



*Arm opening:*

The cross-section of the armhole and waist line is marked with a point 46. The distance between points 46 ÷ 47 is 10 cm and 46 ÷ 48 is 17 cm.

*Expanding the front part:*

From 48 ÷ 49 is measured 2.5 cm; 45 ÷ 50 is 41 cm; 49 ÷ 50 is 15 cm. The line, which is marked with scissors means that line, is cut. Pieces marked with points 30', 49, 50 and 45 (B) are divided into 6 pieces that are drawn vertically and are marked with scissors. The verticals are cut and extending. Expansion should be at least 50 %.

*Distance between the hook and loop fastener points:*

36 ÷ 51 is 1.5 cm (first fastener), 51 ÷ 52 is 14 cm (second fastener), and 52 ÷ 53 is 14 cm (third fastener).

*Modeling of back part:*

The extension of neckline is 0.5 cm to the right (23 ÷ 24). Connect points 22 and 24 with a curved line. That part is being marked because it's falling off. Between points 20' ÷ 25 is measured 10 cm. Point 25 is merged with point 7 (narrowing of the back part). The rest, to the left, is being marked because that part is falling off. Distance between the points 4 ÷ 26 = 4' ÷ 27 is 5 cm.

The line is marked with scissors because that part is going to be cut. The piece marked with points 27, 26, 5 and 25 (A) is divided into 8 parts through which the verticals are withdrawn and marked with scissors. Verticals intersect and expand. Enlargement should be at least 50 %.

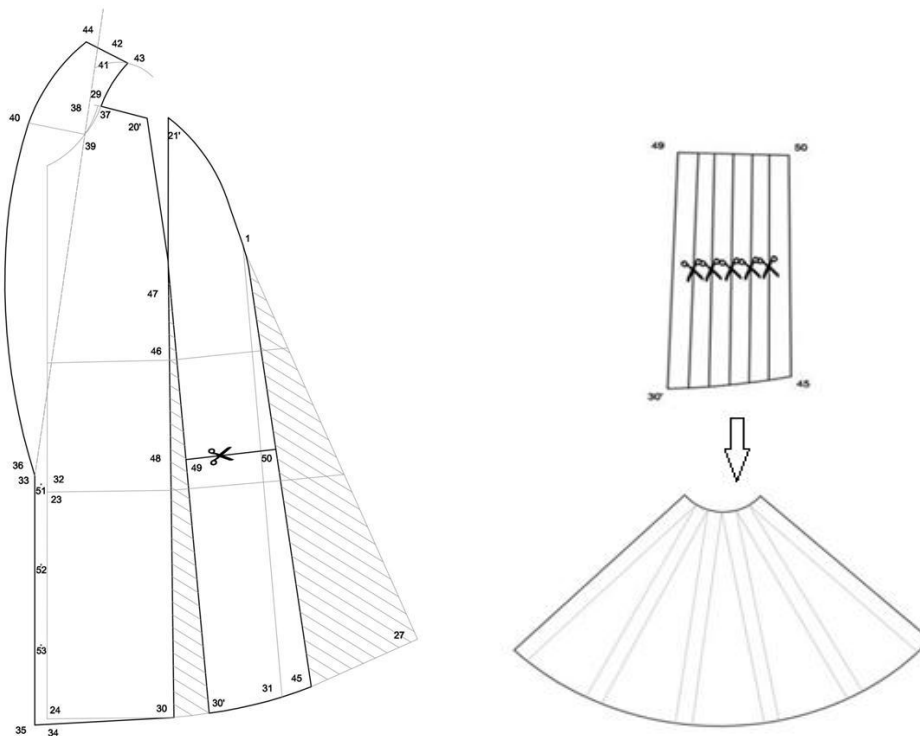
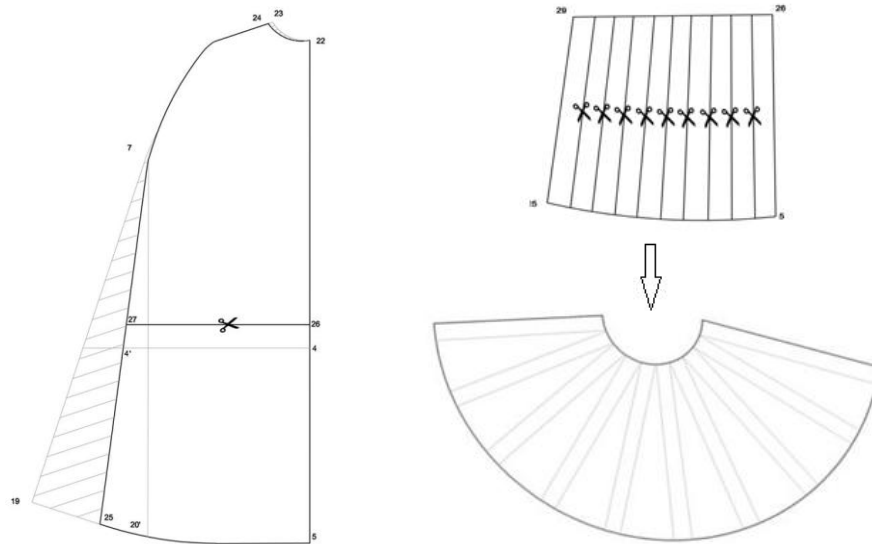

Figure 4: Modeling front part of women's cape



*Figure 5: Modeling back part of women's cape*

#### **Add to seams of pieces and finished pieces for women`s cape**

The design and modeling pieces of women's cape for front and back part have seams. Figure 6 shows all pieces on cape with added seams. All seams on the upper edge and sides are 1 cm, and seams on the hem of cape are 3 cm. Figure 7 shows all the pieces from the front and back part of the women's cape prepared for cutting and the default grain line direction.

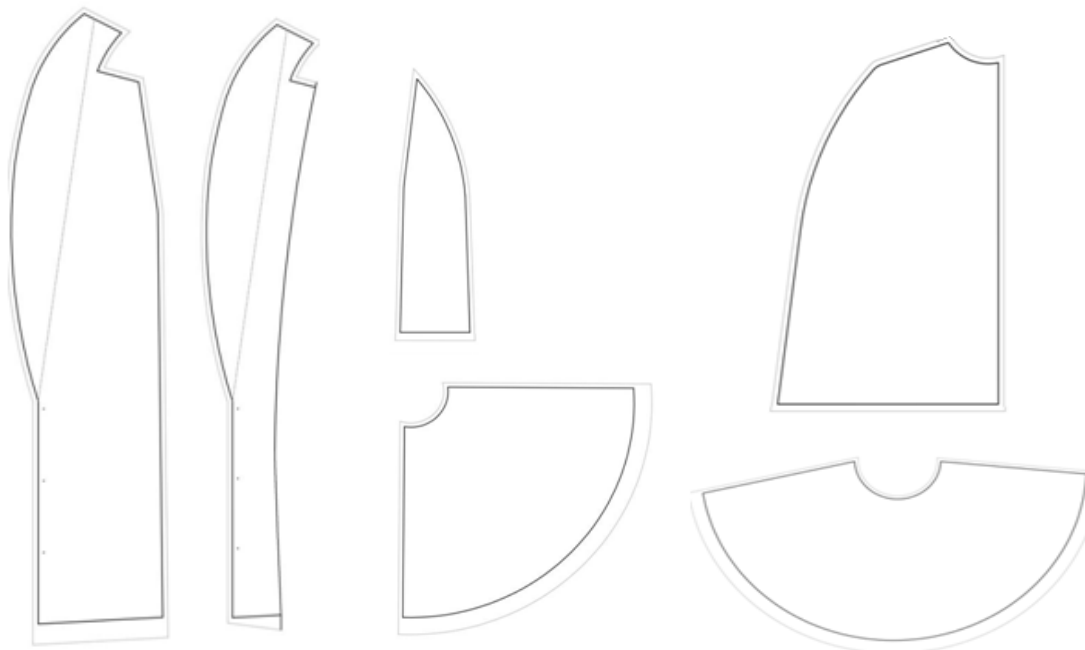

*Figure 6: Pieces with seams for front and back part of women`s cape*

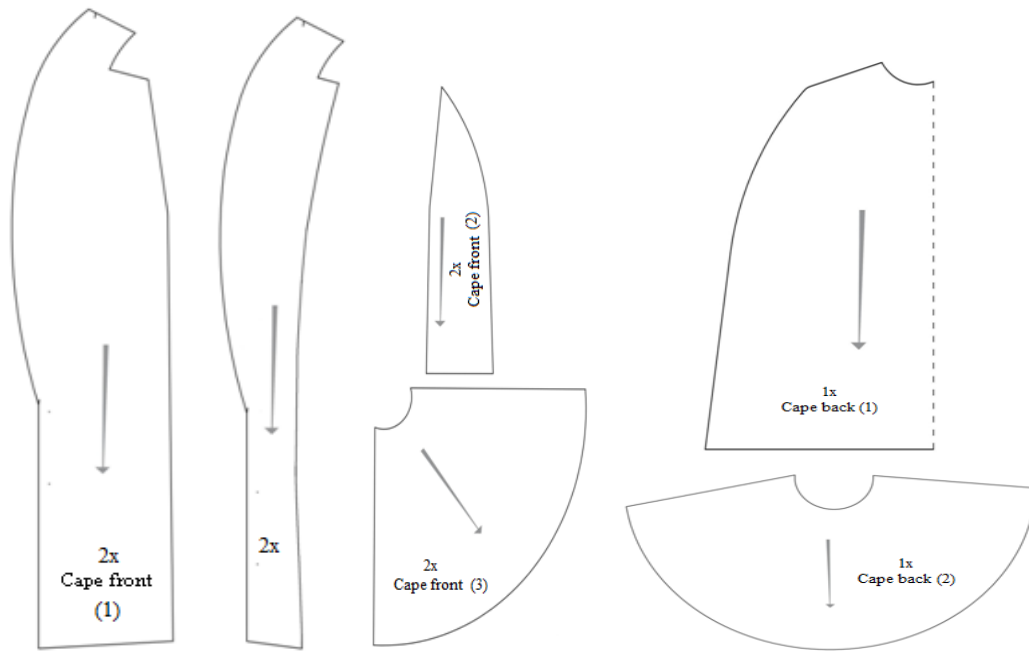

*Figure 7: All pieces of women`s cape prepared for cutting, (front and back parts)*

## CONCLUSION

The purpose of this research is to create new models of women's cape and their construction. Women's jacket was taken as inspiration. The measures needed to make the basic yen cap model have been defined, after which the construction is approached. Modeling is performed on the basic pattern of the cape of front and back parts.

Women cape should follow the body line, which is achieved by shrinking the basic cut and depends on the model.

Faster development of fashion and design demands that new models of construction and modeling be applied to meet consumer wishes and fashion clothing. Next to the classic model of construction, use the design elements of other apparel can come up with a new, more interesting and modern design.

## REFERENCES

- [1] Cho Y., Komatsu T., Inui S., Takatera M., Shimizu Y., Park H. (2006). Individual Pattern Making Using Computerized Draping Method for Clothing, *Textile Research Journal*, 76(8), 646-654.
- [2] Wheelwright S.C., Clark K.B. (1992). *Revolutionizing product development: quantum leaps in speed, efficiency, and quality*, Simon and Schuster, USA
- [3] Veryzer R.W., Borja de Mozota B. (2005). The impact of user-oriented design on new product development: An examination of fundamental relationships, *Journal of product innovation management*, 22(2), 128- 143.
- [4] O’Cass A. (2000). An assessment of consumers’ product, purchase decision, advertising and consumption involvement in fashion clothing, *Journal of Economic Psychology*, 21(5), 545-576.
- [5] Hines T., Bruce M. (2007). *Fashion marketing*, Routledge, UK
- [6] Giovannini S., Xu Y., Thomas J. (2015). Luxury fashion consumption and Generation Y consumers: Self, brand consciousness, and consumption motivations, *Journal of fashion marketing and management*, 19(1), 22- 40.
- [7] Lu J., Ma J., Zhang G., Zhu Y., Zeng X., Koehl L. (2011). Theme-based comprehensive evaluation in new product development using fuzzy hierarchical criteria group decision-making method, *IEEE Transactions on Industrial Electronics*, 58(6), 2236-2246.
- [8] Sung K.S. (2004). A Study of Fashion Model Image According to Fashion Trend since 1960. *Journal of the Korean Society fashion and beauty*.
- [9] Kim M.H, Kim S.H. (2008). A Study on the Change of Fashion Model`s Image with the Changes of the Times. *The Costume Culture Association*, 16, 735-747.
- [10] Joung E.A., Sohn S.Y. (2010). Labor Experiences of Fashion Models in Korea: Acceptance of ‘Body Project’ and ‘Pro(fessional) Spirit’. *Korean Association of Women’s Studies*. 26, 1-30.
- [11] Ujevic D., Rogale D., Hrastinski M. (2000). *Tehnike konstruiranja i modeliranja odjeće*, Tekstilno-tehnološki fakultet, Zagreb, Zrinski d.d. Čakovec.

## IMPROVING COMPETITIVENESS THROUGH CLUSTERING IN THE DOMESTIC TEXTILE INDUSTRY

Mihalj Bakator<sup>1</sup>, Dragan Čočkalović<sup>1</sup>, Dejan Đorđević<sup>1</sup>, Sanja Stanisavljević<sup>1</sup>, Srđan Bogetić<sup>2</sup>

<sup>1</sup>University of Novi Sad, Technical faculty "Mihajlo Pupin", Zrenjanin, Serbia

<sup>2</sup>Academy of Business Professional Studies Belgrade, 11000 Belgrade, Kraljice Marije 73, Republic of Serbia  
srdjan.bogetic@bpa.edu.rs

### ABSTRACT

*In this paper clustering in the domestic textile industry in the Republic of Serbia is analyzed. More precisely, the potential of clustering for competitiveness increase is addressed. The textile and garment industry in Serbia faces challenges in the domain of productivity, competitiveness and new technology applications in manufacturing. These challenges are the result of a transitional economy, and old equipment in the textile and garment industry. Now, this paper discussed how clustering can improve the situation in the textile industry in Serbia. Certainly, clustering has its advantages such as increased productivity, lower operational costs, and a competitive advantage on the market. However, there are disadvantages of clustering as well, such as lower flexibility to changes in technology, and issues which may emerge in case an enterprise leaves the cluster and it negatively affects the rest of the enterprises in the cluster. This paper focuses on the trends in Serbia and analyzes the possibility of clustering as a basis for future research.*

**Key words:** textile industry, SMEs, clusters, clustering, competitiveness

### INTRODUCITON

Clusters can significantly contribute to competitiveness of enterprises. In the research of Anicic et al. (2013) it was noted that small and medium-sized enterprises (SMEs) in the Republic of Serbia could increase their competitive advantage through clustering. Clusters, as a complex system of business associations, has the potential to improve the business performance of the enterprises within the cluster. The European Union acknowledged clusters as a way to increase economic prosperity. This prosperity comes from incentives towards innovation, technological transfers, greater competitiveness, increased productivity, and improved quality management systems (Anicic et al., 2013).

The most important countries in the textile and garment trade in the world are the European Union and Asia where the majority of trade comes from China (Stokanic, 2009). In the same research it was noted that Serbia has a marginal role in the world textile trade and it doesn't show high levels of competitiveness. However, it was also pointed out that comparing the results from previous years it seems that there is a positive trend in the Serbian textile industry. Yet, there are still a lot of issues, especially in the domain of new technologies and age of equipment used in the textile and garment industry.

As mentioned in the research conducted by Vukotić, Aničić, & Laketa, (2013), overall there is a lack of initiative towards developing business incubators, clusters and technology parks. In the same research it was noted that approx. 38% of all employees in the European Union work in enterprises which are part of clusters. Therefore, it is safe to assume that clusters play an important role in the economic landscape in the EU, which further alludes that clusters are surely important for the Serbian economy as well. In order to structurally present this presents paper's analyses, the following research questions will be used as guidelines:

1. How far has the Serbian textile industry come, and what challenges does it face
2. Can clustering solve the current problems of the Serbian textile industry?
3. What steps should be taken in order to achieve higher competitiveness?

In this paper the textile and garment industry in Serbia is analyzed. In addition, the potential of clustering is investigated. The main goal is to provide an adequate basis for future research in this domain. The first section of the paper addresses the textile industry in Serbia. Following this section, clustering and the advantages of clusters are discussed. Afterwards, conclusions are drawn and guidelines for future research are given.

## **ANALYZING THE BUSINESS ASPECTS OF THE TEXTILE AND GARMENT INDUSTRY IN SERBIA**

The most productive enterprises are the ones with high quality machinery and equipment. The majority of these enterprises are in the pharmaceutical industry, food industry, and enterprises with foreign capital. Further, these enterprises make out 8.5 to 9% of the Serbian industry. Productivity in Serbia is low, and this is mainly due to the large number of employees in the public sector. Other reasons for low productivity are not fully realized transition of private enterprises and investments into the domestic economy are very low. As productivity is low, it additionally brings negative consequences in the form of low employment rates, lack of competitiveness, underdeveloped economy, lower consumption rates, increase in foreign trade deficit and less employment opportunity for unqualified workers. Further, age of equipment also has a big impact on business productivity. The average age of equipment in Serbia is 29.5 years, which is two decades more compared to the European Union average (Bogetić Đorđević, & Randić, 2011). This has been confirmed on a representative sample of 154 small, medium-sized and large enterprises within six industries and similar production programs. For reference, we can compare Serbia to Austria as they possess similar natural, social and population characteristics. The results of the comparison are grim, as Austria is ahead of Serbia in the textile industry by 35 years, and in the metalworking industry by 34.5 years. Only in the pharmaceutical industry the position is a little better, as Serbia lacks 21 years compared to Austria.

If the whole situation is viewed on a regional level, the age of equipment, machines and other manufacturing tools is the highest in the southern region of Serbia (41 years), and the best situation is in the Bačka district (where the lacking behind is 18,5 years). In Belgrade, the industry lacks behind by 20,5 years. One of the reasons is that only 26% of investments are going towards new equipment, while the rest is going towards buying second-hand and repaired equipment.

The lack of increase in productivity in newly formed enterprises (with foreign capital), is not the result of low capital investment focused organizations, but the problem is that labor-intensive organizations focus on larger number of workers rather than using modern technologies. This is somewhat understandable, as foreign enterprises which invested into the domestic economy, did it because of the incentives which are given by the Republic of Serbia, and also because of the cheap labor force. If viewed in this manner, it would mean that business efficiency is achieved through employing new workers who conduct only manual labor, and whose compensation is significantly less compared to countries (most often the EU) from where the foreign investor came in the first place.

According to the analysis conducted by the World Economic Forum (Insight report, 2018), East European countries are interesting for investors in the manufacturing sector, primarily because of the low labor costs, and secondarily because of availability of high quality experts and quality supply chains. In the first three quarters of 2018, in the Republic of Serbia, the amount of direct foreign investments was around 2 billion euros (Bilten Udruženja za industriju tekstila odeće i obuće, 2018). Of this amount 33% was invested in the processing industry, 51.89% in the services industry, and 17.3% from that amount was invested in the textile industry. In 2018, in the textile industry the number of employed people was 12,679. Further, in the garment industry the number of employees was 31,116, while in the leather manufacturing industry there were 14,351 employees (Republički zavod za statistiku, 2019). It can be assumed that the number of employees is a little higher due to the grey economic climate. Overall, there are around 2000 enterprises in the mentioned industries.

Based on the presented data, it can be concluded that productivity in textile, garment and leather enterprises is low, not only because they are labor-intensive industries, but also because of inadequate investments, primarily from foreign investors. Certainly, productivity and business quality are positively correlated and they directly affect enterprise competitiveness. Thus, it can be concluded that enterprises competitiveness in the textile, garment and leather industry is not on a high level.

Analyzing the textile, garment and leather industry export performance, it can be seen that EU countries dominate when it comes to imports from Serbia, then there is Russia, as well as a few neighboring countries. In Table 1, data on countries are given in which Serbia exports goods from the textile and garment industry.

*Table 1: Countries where Serbia exports goods from the textile and garment industry*

#	Country	Export (in millions of euros)
1.	Italy	416,7
2.	Germany	125,2
3.	Russia	118,5
4.	Bosnia and Hercegovina	76,6
5.	Romania	53,8
6.	Croatia	46,6
7.	Montenegro	38,5
8.	Slovenia	29,6
9.	Macedonia	27,3
10.	Belgium	26,1

Source: (Bilten Udruženja za industriju tekstila odeće i obuće, 2018)

So, it can be seen from the presented Table 1, that the main focus of exports are on the region and a few countries in the EU, as well as Russia, which practically means that the regional European market is covered. Enterprises are relatively competitive on this regional European market, mainly due to cheap workforce.

## **ACHIEVING COMPETITIVENESS WITH CLUSTERING**

Clusters are an important way of merging SMEs, as they can achieve higher competitiveness compared to large enterprises. Further, through clustering, SMEs can significantly contribute more for the regional growth of the economy. Clusters as a business association, has numerous other positive results for SMEs, such as introducing them to quality management systems, more effective research and development, newer technologies, innovations, new markets and better position on these new markets. Additionally, clustering can lower operating costs, and increase cooperation with research institutions (Aničić, Zakić, Vukotić, & Subić, 2016). All these positive results are coming from the distribution and sharing of knowledge, technology and infrastructure. Within clusters, there is a definite cooperation between the SMEs, thus professional competitiveness fears are not present in a threatening way. As a result, there is favorable ground for knowledge sharing and mutual skill development (Kaličanin, & Gavrić, 2014).

As mentioned, clusters are a crucial part of the competitiveness enhancement process. Also, clusters are becoming a necessity for productivity and development improvement in small and medium-size enterprises (SMEs) in transition economies. An even more evident importance of clusters in transition economies is in the textile industry as enterprises in this sector have issues regarding competitiveness on the domestic market. Here, the merging of enterprises may help in achieving strategic goal on the market. The whole integration process is way for SMEs to be actively involved in the world economy framework (Đorđević, Čočkalović, Urošević, & Đekić, 2011). A simple model of how SMEs function within a cluster is depicted on Figure 1.

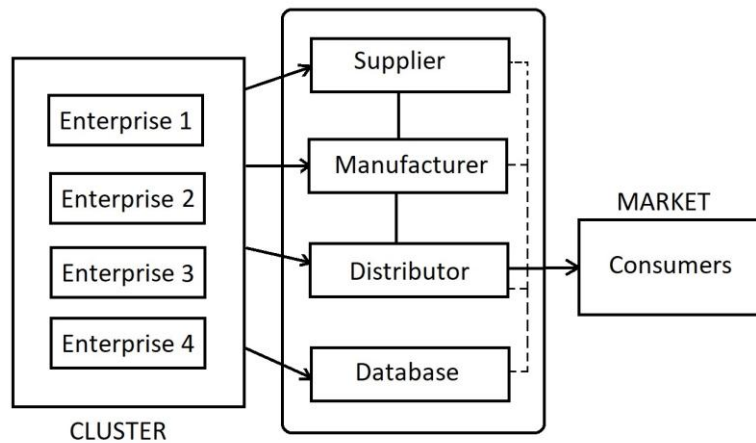

*Figure 1: SMEs in a cluster*

The model depicted on Figure 1, presents how a basic cluster includes SMEs and some of the business activities. The cluster merges, in this case, four enterprises. The second block includes the supplier, manufacturer, distributor and the database. The cluster is connected with these business activities. The database keeps storage on reports, documents and projects. In addition, through the database SMEs can share acquired knowledge on business, technologies, innovations, and how to increase employee skills. The third block presents the market, or consumers. Through clustering, enterprises collectively use resources in the form of suppliers, manufacturers, distributors, and knowledge from the database. This way operational costs are substantially lower, productivity is higher, and most importantly SMEs have more competitive power on the market. Enterprises can conduct business more efficiently, and generally have shorter reaction times towards the changes on the market. Overall, clusters provide a more stable flow of resources, as before separate suppliers are now collective, and the cost of failure is significantly lower (Silvia, 2009). However, clustering has its disadvantage such as vulnerability when it comes to changes in technology, as SMEs within clusters are somewhat locked in with old equipment. In addition, if an enterprise within the cluster closes, it could negatively affect the rest of the enterprises even if these are competitive. Finally, only a few number of clusters are regionally recognized, thus it is important to develop sound long-term strategies which will minimize the risks and maximize gains for SMEs who are merging.

## CONCLUSION

This paper provides a concise overview of the textile industry in Serbia. In addition the positive aspects of clustering are discussed. It is evident that Serbian textile and garment enterprises have to merge into clusters and to improve existing ones.



It can be concluded that clusters are an integrated part of economic prosperity. Enterprises have to consider the benefits of business associations – clusters, in order to achieve better competitive ability. Compared to the EU countries Serbia lags behind in new technology application and production. On a global scale the presence of the Serbian textile industry is practically non-existent. A few countries in the EU and neighboring countries are the primary, if not only, export destinations. Further, the research questions are addressed:

1. How far has the Serbian textile industry come, and what challenges does it face?

There is certainly improvement in the Serbian textile industry in the past 10 years. However, there are still a lot of challenges. The old age of equipment and machinery used in the textile industry negatively affects productivity, quality and competitiveness on the market. This issue is at the same time the biggest problem of the Serbian textile and garment industry. Old equipment and old machinery significantly affect operational costs and limit innovations, research and development. New employees can't bring higher productivity as the insufficient technological advances "bottleneck" the progress.

2. Can clustering solve the current problems of the Serbian textile industry?

As mentioned before, clustering can solve a large set of problems. Increased productivity, better logistics in the distribution sector, supplier integration, manufacturing optimization and more room for innovations are the main positive aspects of SMEs merging into clusters. In addition, clustering more often than not, creates more jobs. However, clusters carry certain disadvantages as well. For example, enterprises within clusters are locked when it comes to new technology implementation. Additionally, if one member of the cluster leaves or closes business, the other members may have problems with suppliers, manufacturing processes and distribution. Now, given the current situation in the Serbian textile industry, clustering is welcomed and encouraged.

3. What steps should be taken in order to achieve higher competitiveness?

Newer equipment and newer machines should be introduced into the production process. New technologies should be analyzed and included in the research and development processes. Clusters should be oriented towards innovations and new technologies. Flexibility within the clusters is necessary to reduce risk of stagnation. Through clustering, new technologies and innovation, the Serbian textile industry could achieve higher competitiveness on the market.

Furthermore, the limitation of this paper is the lack of survey data from textile and garment manufacturing enterprises. However, due to the goal of the study, this limitation is not an issue. Next, this paper provides a solid basis for future research in this domain. Meta-analysis could be conducted in order to present a "bigger picture" of how clustering can affect the textile and garment manufacturing enterprises.

## **ACKNOWLEDGEMENT**

This work is a result of the project financed by the Ministry of Education, Science and Technological Development of the Republic of Serbia, Grant TR 35017.

## REFERENCES

- [1] Anicic, J., Vukotic, S., Zakic, N., Laketa, M., & Laketa, L. (2013). Clusters as a model of economic development of Serbia. *UTMS Journal of Economics*, 4(3), 341-353.
- [2] Aničić, J., Zakić, N., Vukotić, S., & Subić, J. (2016). Clustering as an opportunity for internationalization of the SME sector in Serbia. *Journal of Balkan and Near Eastern Studies*, 18(5), 506–524. doi:10.1080/19448953.2016.1196013
- [3] Bogetić, S., Đorđević, D., Randić, D. (2011). Analiza mogućnosti za unapređenje konkurentske sposobnosti domaćih preduzeća. *Zbornik radova VIII Skup privrednika i naučnika "Operacioni menadžment i globalna kriza"*, Beograd, 1-2. novembar 2011., FON Beograd, Centar za operacioni menadžment Beograd, Privredna komora Srbije, Beograd
- [4] Đorđević, D., Čočkalović, D., Urošević, S., & Đekić, V. (2011). Clusters and Competitive Ability of Small and Medium Enterprises in the Textile and Clothing Industry: Serbian Economy Review. *Fibres & Textiles in Eastern Europe*, 19(5), 88.
- [5] Insight report (2018). The Future of Jobs 2018. World economic Forum 2018, [www.weforum.org](http://www.weforum.org)
- [6] Kaličanin, Đ., & Gavrić, O. (2014). The importance of clusters as drivers of competitive advantage of companies. *Ekonomika preduzeća*, 62(3-4), 164-172.
- [7] Registrovana zapsolenost, godišnji proseki 2018., Saopštenje br. 18, godina LXIX, 31.01.2019., Republički zavod za statistiku, Beograd.
- [8] Silvia, M. (2009). Advantages and disadvantages of clusters—A theoretical approach. *Revista Economică*, 1, 36.
- [9] Stokanic, D. (2009). *Entrepreneurship on the margin between informality and formality: The textile industry in South-West Serbia*. Budapest: Central European University, Department of Sociology and Social Anthropology.
- [10] Udruženja za industriju tekstila odeće i obuće. (IV kvartal 2018). *Bilten*. Privredna komora Srbije, Beograd, 2018., str. 16., [www.p4.ks.org](http://www.p4.ks.org)
- [11] Vukotić, S., Aničić, J., & Laketa, M. (2013). Clusters as a part of improvement function of Serbian economy real sector competitiveness. *Amfiteatru Economic Journal*, 15(33), 224-245.

## E CHANGE IN DRAPE COEFFICIENT OF WOVEN FABRICS WITH SEAMS

Tatjana Šarac\*, Nenad Ćirković, Jovan Stepanović, Dušan Trajković, Nataša Stamenković  
Faculty of Technology in Leskovac, University of Nis, Serbia  
e-mail \*[tangerine.art83@gmail.com](mailto:tangerine.art83@gmail.com), [nenadcira@gmail.com](mailto:nenadcira@gmail.com), [jovan64@yahoo.com](mailto:jovan64@yahoo.com), [duasant@excite.com](mailto:duasant@excite.com),  
[nradmanovac@gmail.com](mailto:nradmanovac@gmail.com)

### ABSTRACT

*Draping can be described as a phenomenon of the formation of a fold when the fabric is folded with its own weight, without the influence of external forces. Draping is a phenomenon whose complexity is not easy to quantitatively present because it is influenced by several parameters such as structural and mechanical characteristics of fabrics and external environmental influences. In this paper are analyzed fabrics of raw material composition 100% cotton and 100% polyester, with different linear densities and densities of warp and weft wires, interlacing and surface masses. For the purpose of testing drape coefficient, samples of fabrics with seams of the same dimensions were made as samples of fabrics without seams. The seams are made in the middle of the sample in the warp direction, the length of the stitch is 2 mm and the width of the seam allowance is 1 cm. The seams are folded and ironed at a temperature of 180°C.*

*The goal is to determine the changes in the drape in fabrics with seams in relation to fabrics without seams. Adding the seams results in an increase in the surface mass in the part of fabric that hangs due to folding of the fabric and the presence of the sewing thread in the seam area, which also increases stiffness of the fabric. The test was carried out on the Drapemeter according to the British Standard BS5058. The results of the study show that the values of drape coefficients increases in fabrics with seams compared to seamless fabrics.*

**Key words:** draping, drape coefficient, seam, fabric.

### INTRODUCTION

Draping can be described as a phenomenon of the formation of a fold when the fabric is folded with its own weight, without the influence of external forces. Draping of textile materials has a synonymous of phenomenon, because draping is very difficult to quantitatively present. It depends on many factors, such as the structural and mechanical characteristics of fabrics, and then external influences (time of draping, length of a draped part, type of pedestal, wind effect, etc.). Current findings indicate that the researchers have mainly explained the phenomenon of draping based on the mechanical properties of textile materials. Special attention is focused on linking the coefficient of draping with surface mass and the fabric rigidity. However, with the change of any parameter of the fabric, its drape drastically changes, not only in terms of changing the drape coefficient, as a numerical drape indicator, but also in terms of changing the configuration of the drape, number and distribution of the folds, the size of the folds, i.e. minimum and maximum amplitude. All these reasons requires that draping needs to be further investigated.

Draping is an important factor in presenting aesthetics and fabric functionality, as well as the clothes itself. When it comes to clothes and draping of materials from which the clothes are made, the presence of seams must be taken into account as the most widespread method of joining clothes pieces. Bearing in mind the preliminary knowledge about the influence of different parameters on the draping of materials, it is important to study the effect of seams on the drape coefficient. The goal in this paper is to determine the changes in the drape in fabrics with seams in relation to fabrics without seams. Adding the seams results in an increase in the surface mass in the part of fabric that hangs due to folding of the fabric and the presence of the sewing thread in the seam area, which also increases stiffness of the fabric.

The results obtained in this study can be used in the projecting of textile materials drape. Investigating the draping under different influences is important for virtual display of clothing as well as for computer graphics.

## MATERIALS AND METHODS

In this paper are analyzed fabrics of raw material composition 100% cotton and 100% polyester, with different linear densities and densities of warp and weft wires, interlacing and surface masses (table 1). For the purpose of this test, samples of a circular shape of diameter of 30 cm are made according to the standard for drape testing. From each fabric samples are made without seams and with seams. The seams are made in the middle of the sample in the warp direction, the length of the stitch is 2 mm and the width of the seam allowance is 1 cm. The seams are folded and ironed at a temperature of 180°C.

*Table 1: Characteristics of tested fabrics*

Sample number	Raw material composition	Linear density (tex)		Thread density (cm <sup>-1</sup> )		Weave	Surface mass (g·m <sup>-2</sup> )
		warp $T_{l,wa}$	weft $T_{l,we}$	warp $d_{wa}$	weft $d_{we}$		
1	Cotton 100 %	28x2	28,5x2	24	21	Plain	304,40
2	Cotton 100 %	25	20	35	25	Plain	157,45
3	Cotton 100 %	8.4	8.4	46	36	Plain	78,63
4	Cotton 100 %	30x2	30x2	22	20	Twill 4/4	298,63
5	Cotton 100 %	20	14	29	36	Caro fabric	131,53
6	Cotton 100 %	24	30	37	26	Twill 2/1	219,57
7	Cotton 100 %	20x2	20x2	22	21	Broken twill 2/2	184,25
8	Polyester 100%	30	40	40	45	Twill 1/2	167,56
9	Polyester 100%	8.4	14	40	29	Twill 2/1	81,63
10	Polyester 100%	28	10	38	24	Plain	123,05

Draping was examined on a non-standard draping test device. The device consists of the top and bottom glass panels. Between them is a circular pedestal with a diameter of 18 cm, on which a sample with diameter of 30 cm is placed. Below the bottom plate there are 4 light bulbs arranged in 4 angles that illuminate the bottom plate onto which the milk paper is glued. The sample is illuminated from the bottom to make the edges more clearly visible. Above the device is a camera that records the configuration of the draped sample from above.

Photographs are processed using software Adobe Photoshop. By this digital method, the drape profile of a sample is recorded with digital camera which is mounted on the stand above the drape meter at a certain height so that it covered the top panel of the device, then the resulting image is being processed in software Adobe Photoshop (Figure 1). First is carried out cutting and calibration of the image (Figure 1a), then the image is processed to set the threshold between black and white (Figure 1b). Then it is necessary to clean the image, where on black surface white pixels are removed, and the black pixels on white surface (Figure 1c). Image becomes black - white, and then the surface can be easily marked and number of pixels can be calculated. Adobe Photoshop contains tools for easy and accurate recalculation of pixels in any marked area. The procedure for obtaining the drape coefficient is the same for samples without seam as well as for samples with seams.

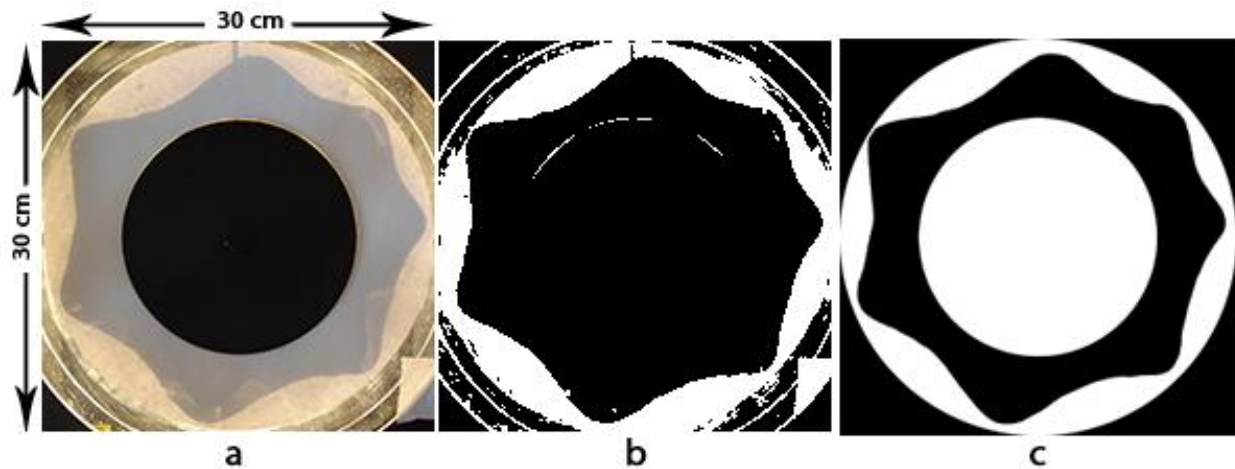

Figure 1: Image processing using Adobe Photoshop: a) cutting and calibration of the image, b) setting the threshold between black and white, c) cleaned image draped simple

## RESULTS AND DISCUSSION

Table 2 shows the results of testing the drapability coefficient of fabrics without seams and fabrics with seams. The test was carried out on the face and on the back of the fabric, and then are calculated the mean values.

Table 2: results of testing the drapability coefficient

Sample number	Drape coefficient DC (%) of fabrics without seams			Drape coefficient DC (%) of fabrics with seams		
	face	back	mean value	face	back	mean value
1	75,34	77,17	76,25	81,26	81	81,13
2	55,61	58,1	56,86	55,97	59,55	57,76
3	41,66	38,26	39,96	43,26	42,75	43
4	44,09	45,78	44,93	45,84	51,02	48,43
5	31,13	32,47	31,8	32,48	33,99	33,24
6	59,47	61,69	60,58	66,26	70,52	68,39
7	31,91	31,72	31,81	33,77	33,03	33,4
8	51,3	59,47	55,38	53,99	70,93	62,46
9	23,24	23,16	23,2	23,24	23,17	23,2
10	59,8	55,61	57,7	65,94	66,89	66,41

Figure 2 shows the drapability coefficient values for fabrics without seams and fabric with seams on the face of the fabric. Figure 3 shows the drapability coefficient values for fabrics without seams and fabric with seams on the back of the fabric. Figure 4 shows the mean values of drapability coefficient for fabrics without seams and fabric with seams.

Based on the obtained results of draping fabrics without seams and fabrics with seams, it can be concluded that fabrics with seams have higher drapability coefficient values than fabrics without seams.

As expected, fabrics of lower values of surface mass (lower density of warp and weft threads, as well as lower values of linear densities of warp and weft threads), have lower drape coefficient values, or better drapes than fabrics higher values of surface mass. Surface mass also affects the rigidity of the fabric, the greater the stiffness of the fabric, the less is their ability to drape.

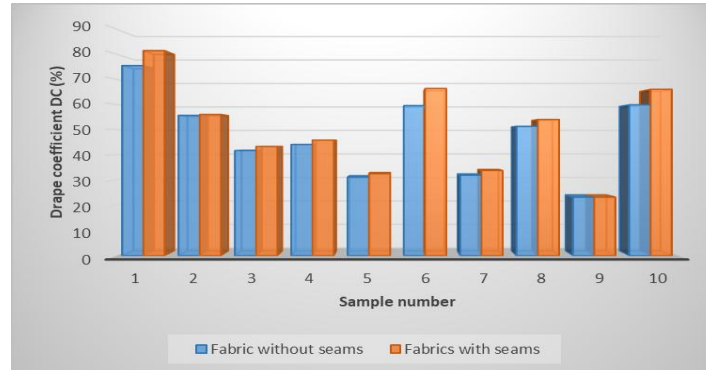

Figure 2: Comparison of drape coefficient values for fabrics without seams and fabric with seams on the face of the fabric

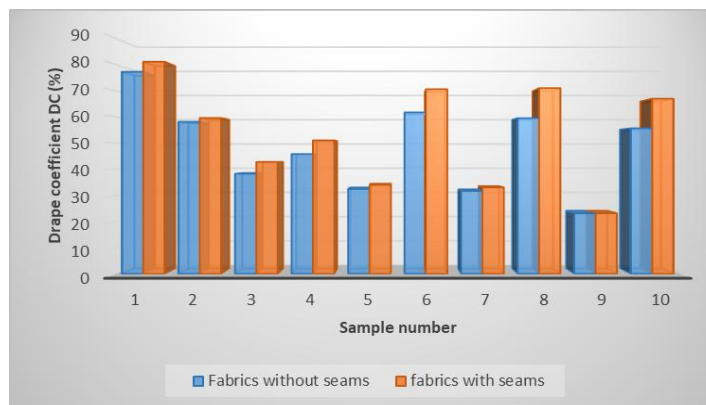

Figure 3: Comparison of drape coefficient values for fabrics without seams and fabric with seams on the back of the fabric

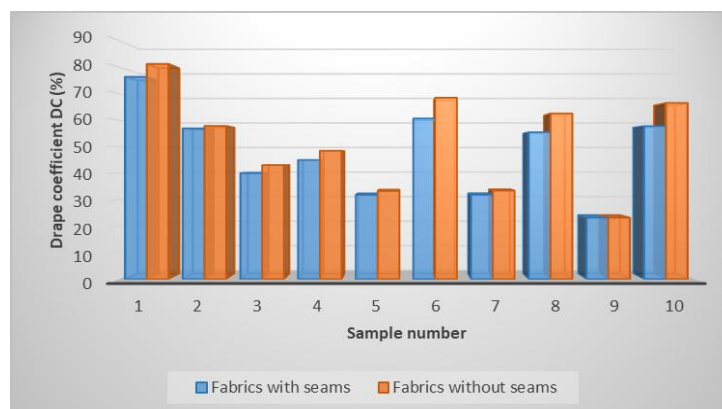
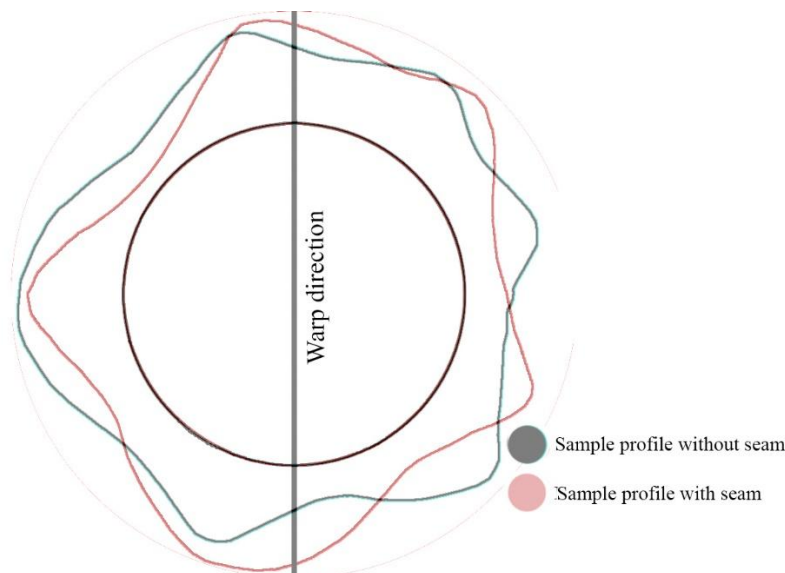

Figure 4: Mean values of drape coefficient for fabrics without seams and fabric with seams

In Figures 2 and 3, it can be seen that the tested samples have similar values of drape coefficients on the face and on the back of the fabric, as well as the similar values of the increment of the drape coefficient of fabrics with on face and on back of the fabric. From Figure 4, it can be concluded that fabrics that have higher values of drape coefficient without seams have a higher increase in drape coefficient for samples with seams compared to fabrics that have lower drape coefficient values.

A slight increase in the drape coefficient occurs in the area of the seam itself, because in this part, due to the presence of the sewing thread and folding of the fabric, a greater stiffness of the fabric occurs. Woven fabrics that have higher stiffness have higher values of drape coefficients, which additionally increases with the presence of seams, while the less stiffer fabrics have lower values of drape coefficient which slightly increases with adding seams.

By adding the seam on the warp direction of the sample, the configuration of the drape profile changes in most of the tested samples. Figure 5 shows an example of a draping profile of the fabrics without seams and fabrics with seams. The conclusion is that by adding the seam, the fold is formed in the area of the seam.



*Figure 5: Draped profile of sample without seam and sample with seam*

## CONCLUSION

In order to explain the phenomenon of fabric drape, a number of parameters that affect the draping of fabrics must be taken into account, and the fact that the change in any parameter of the fabric influences the change in the drape coefficient and the configuration of the draped sample. In this paper an attempt was made to explain the change in the draping of fabrics with seams. The obtained results are expected, e.i, the fabrics in which the seam is added in the warp direction, in the middle of the sample, have higher values of drape coefficient than fabrics without seams. However, the drape coefficient, as a numerical indicator of the percentage of the surface of the draped part of the sample, is not a sufficient indicator of the essence of the change in the draping of the sample when the seam is inserted. Configurations of draped samples show that in area of the seam is always formed a fold with larger amplitudes, whereby there is increase of drape coefficient and, also the change in configuration of the draped profile. This phenomenon has to be further explored in order to numerically illustrate the changes in the configuration of the draped profile of the fabric with the inserted seam. Research of the draping of fabrics with seams, as well as draping of fabrics is generally important for virtual display of clothing and computer graphics.

## REFERENCES

- Kenkare N., May-Plumlee T., Evaluation of drape characteristics in fabrics, *International Journal of Clothing Science and Technology*, Vol. 17 No. 2, 2005, pp. 109-123
- Žunič Lojen D., Jevšnik S., Some Aspects of Fabric Drape, *FIBRES & TEXTILES in Eastern Europe*, October / December 2007, Vol. 15, No. 4 (63).
- Saville B P, Physical testing of textiles, Woodhead Publishing Limited in association with The Textile Institute, Abington Hall, Abington, 2000.
- Robson D., Long C. C., Drape Analysis using Imaging Techniques, *Clothing and Textiles Research Journal* 2000; 18; 1
- Orzada B. T., Moore M. A., Collier B. J., Chen J. Y., Effect of laundering on fabric drape, bending and shear, *International Journal of Clothing Science and Technology*, Vol. 21 No. 1, 2009, pp. 44-55
- Sharma K. R., Behera B.K., Roedel H., Schenk A., Effect of sewing and fusing of interlining on drape behaviour of suiting fabrics, *International Journal of Clothing Science and Technology*, Vol. 17 No. 2, 2005, pp. 75-90
- Matusiak M., Influence of the Structural Parameters of Woven Fabric on their Drapeability, *FIBRES & TEXTILES in Eastern Europe* 2017., 25, 1(121); 55 – 56.
- Buyukaslan E, Kalaoglu F, Jevsnik S, Drape simulation and subjective assessment of virtual drape, 17th *World Textile Conference Autex 2017- Textiles - Shaping the Future, Materials Science and Engineering* 254 (2017) 162002

**Acknowledgment:** This paper is a part of the research project No. TR – 34020, financed by the Ministry of Education, Science and Technological Development of the Republic of Serbia.



## SUBJECT OF COPYRIGHT

Nadežda Ljubojev, Mila Kavalić\*, Sanja Stanisavljev  
University of Novi Sad, Technical faculty "Mihajlo Pupin", 23000 Zrenjanin,  
Đure Đakovića bb, Republic of Serbia  
milazakin@gmail.com

### ABSTRACT

*An author of a work is a person who has created an authorial work. Today, in copyright law, a definition is adopted according to which the author's work implies original human creation, which has a spiritual content and a particular form in which it is expressed. An author is the spiritual creator of a work. A co-authorial work is a spiritual creation of co-authors which is created through creative collaboration of two or more persons. Combined works differ from co-authorial works. When it comes to combined works, each work has its author and each of them keeps their individuality. A combined work should be differentiated from collection works as well. The analysis used a historical legal and normative legal method.*

**Key words:** copyright, author and holder of copyright, co-authors and co-authorial work, combined works.

### INTRODUCTION

An author of a work is a natural person who has created an authorial work (Bently & Sherman, 2004; Cornish & Llewelyn, 2007; Gliha, 2017). The subject of copyright protection is a copyrighted work. Subjective copyright is created by the very act of creating an authorial work (Bainbridge, 2007).

The property of being an author is the basis for gaining copyright protection, under the condition that the work which is the reason for the author to realize copyright protection is considered an authorial work according to legal regulations of the country in which the protection is realized. Today, in copyright, a definition has been adopted, according to which the author's work implies *original human creation, which has a spiritual content and a particular form it is expressed in* (Markovic & Popovic, 2013, 38) (Besarovic, 2005; Miladinovic, 2009). Sometimes shades are enough for the authorial work to imprint originality, so that in the reader or viewer they cause a feeling of something unusual or an until then unseen work" (Damnjanovic & Maric, 2007, 47). The originality of the author's work must be judged in an objective way (Goldstein, 2010).

Law on Copyright and Related Rights "Official Gazette Republic of Serbia", no. 104/2009, 99/2011 and 119/2012 (further in the text "LCRR") accepts this method of legal regulation and states, for example, authorial works whose purpose is to provide a basic example of what copyright is and what enjoys copyright protection.

The copyright works are considered:

- written works (books, brochures, articles, translations, computer programs, etc.);
- spoken works (lectures, speeches, words, etc.);
- drama, drama-musical, choreographic and pantomime works, as well as folklore works;
- musical works with or without words;
- film works (cinematographic and television works);
- works of art (paintings, drawings, sketches, graphics, sculptures, etc.);
- works of architecture, applied art, and industrial design;
- cartographic works (geographical and topographic maps);
- plans, sketches, models, photos;
- theatrical plays.

Works of fine arts enjoy copyright protection and are considered copyrighted works under the same conditions as other works of art. In protected works of fine arts, in the narrow sense, they include works of painting, sculpture, graphics, carving, copper cuts, etc. Works of fine art include architectural works (Ljubojev, et al., 2018). Also, author's works include works of applied art and industrial design (Milic, 2009).

Applied art »is the designing and decorating of functional objects or materials to give them aesthetic appeal, e.g. printing type, ceramics, glass, furniture, metal work and textiles« (Encyclopedia of Art). The term is frequently used to differentiate this type of work from the fine arts (painting, drawing, sculpture) whose value is primarily aesthetic.

## **AUTHOR AND HOLDER OF COPYRIGHT**

An author is the spiritual creator of a work (Goldstein & Hugenholtz, 2010). A legal person cannot be an author of a work, considering the fact that creation of an authorial work is a spiritual process (Gliha, 2017). Businesslike capabilities are not necessary for gaining authorial properties, which means that even persons incapable of business (minors, persons with mental health disabilities) can be authors of a work without any limitation. However, these persons realize their authorial rights through a representative (legal or contractual). The property of being an author cannot be gained through an attorney who would create an authorial work for the ordering party, but an authorial work can be created if commissioned by a certain person.

An author is not a person who encouraged someone (gave the idea) to create an authorial work, but the person who turned that idea into an authorial work (Decision of Commercial Court in Belgrade, Pž. 7573-2000 from 06. 02. 2001. *Pravni informator* No. 4-2002).

The person who created an authorial work becomes the author regardless of their volition to be acknowledged and famous as an author, and regardless of the fact that in some cases they want to stay anonymous or for their work to be published under an alias (Ljubojev & Varga, 2014). Still, the author most commonly does not hide their identity. That is why it is assumed, though it can be proven otherwise, that the author of a certain work is the person whose name, alias or recognizable symbol is listed on copies of the work, or during public announcement of the work.

The feature of being an author cannot be transferred to another person, but certain permission from subjective copyright can be assigned or transferred to another person, primarily through an contract, but also through inheritance, as well as directly through law. In that sense, the holder of copyright is every person who is not the author, but is the subject of certain permission from the content of subjective copyright based on contract, inheritance, and in certain cases even law. According to that, the »concept of the holder of copyright« encompasses the author as the original copyright owner, as well as all other persons who gain certain permissions on some legal basis as derivative holders of copyright (Markovic & Popovic, 2013).

The rule is that the original copyright owner is the author, which is characteristic of the continental legal system which is based on the natural-law character of intellectual property.

However, when it comes to the Anglo-Saxon *copyright* system, which is prevalent in the USA law, the original copyright owner can be a person who is not the author of the work (Cooper Dreyfuss & Pila, 2018). This example can be found in film works and works that were created on commission, i.e. ie employment relationship. The original holder of copyright for film works is the film producer, the original holder of copyright of commissioned works is the ordering party, and the original the holder of works created by someone employed to do so is the employer. This rule is of the dispositive character, which means the parties can agree otherwise in the agreement (Miladinovic, 2011, 200–201).

## **CO-AUTHORS AND CO-AUTHORIAL WORK**

A co-author is a natural person who has created a work on the basis of creative work with another person. Thus, an authorial work which is created through collaboration of two or more persons is considered a co-authorial work. The persons who created such a work have the status of co-authors. The legal relations between co-authors are determined by an contract. The contributions of individual co-authors do not necessarily have to be of the same size or quality.

A co-authorial work has to represent a whole, and the co-authors themselves have to have the idea of creating a certain work through a mutual intellectual endeavour. The contributions do not have to be of the same size or quality provided that they contain creative elements.

Co-authorial works can exist in all areas of intellectual creation, literature, art, science (Ploman et al., 2000; Terence 2000). Our legislator does not predict limitations when it comes to the type of work which involves more than one author. Still, the only authorial work which has specific legal regulations as a typical co-authorial work is film works.

When it comes to co-authorship, the controversial question is whether a co-authorial work should represent an indivisible whole, i.e. whether the contributions of individual co-authors can be used independently or not. In comparative law and legal theory, two basic concepts are the most common; the French concept, which is broader, and the German concept, can be considered representative (Besarovic, 2011). According to the French concept, to consider something a co-authorship, only the subjective condition needs to be fulfilled, i.e. that two or more persons created a certain work intending to use the results of their endeavour together as a single authorial work. Thus, for example, the music and words that a composer and a lyricist created in order to use one song to participate at a festival are considered a co-authorship. That means that there has to be cooperation between the two or more authors, as well as the will to use the results of their work together as a unique work. According to the German criterion, in addition to the subjective condition, it is also necessary to fulfil the objective condition, i.e. that this be an intellectual creation which is an indivisible whole (Janjic, 1982, 273).

In our law, the German concept of co-authorship is accepted, thus making creative cooperation and indivisibility of creative contributions the elements of the concept of a co-authorial work. The indivisibility of the whole of an authorial work means that contributions of individual co-authors cannot be used separately.

While it is not possible to identify the creative contributions of individual co-authors for a certain number of co-authorial works, this is possible for other co-authorial works, but the contributions cannot be used separately. The persons that participate in the creation of an authorial work in other ways, offering only technical, financial or other kind of help during the creation of the work, but are not its spiritual creators, are not co-authors. For something to be a co-authorial work, mutual creative cooperation and indivisibility of creative contributions, which result in a mutual creation, are necessary.

Besides that, works that are work of processing or collections are not co-authorial works. They differ, because creative cooperation implies a factual willingness of two or more persons to commit themselves to the unique idea of that work, which is not the case with these forms. Also, any work that one person began and another person finished is not considered a co-authorial work.

The legal consequences of co-authorship are:

- The co-authors are owners of a mutual (unique) subjective copyright on the co-authorial work. In other words, co-authorial copyright is unique copyright covering a unique subject of protection, but with multiple original holders (Markovic & Popovic, 2013, 51).
- To realize co-authorial copyright and the turnover of that copyright, it is necessary for all co-authors to comply. A co-author cannot refuse to comply if it is against the principles of conscientiousness and integrity, i.e. if doing so would hurt the interests of the other co-authors. This basically means that, if the co-authorial work has not been published, in order for it to be published, compliance of all its co-authors is necessary. The same applies if there is a need to change the work, to oppose unworthy use of the work, as well as in the case of withdrawal rights.
- Every co-author is authorized to file a lawsuit in the case of copyright injury. They can file the claims only in their own name and of their own account.
- Economical gain that comes from using the co-authorial work, if not stated differently in the contract, is divided proportionally to the contributions of individual co-authors. Basically, that issue is solved by quantification of creative contributions of individual co-authors in relation to the whole of the co-authorial work. Then, proportionally to the size of that contribution, the amount of the realized property gain to which every co-author has a right is determined (Markovic, 2007). If neither the co-authors nor the court can determine the size of the creative contributions of each of the co-authors, it shall be considered that all of the contributions are equal.
- A co-authorial community comes to exist as a result of the act of creation of a co-authorial work, and it cannot be unmade, since every co-author remains tied to the co-authorial work for life. However, in the case of death of a co-author, the co-authorial community naturally undergoes certain changes. Namely, by inheritance of property-legal entitlement, legal inheritors of a co-author enter the co-authorial community, and after the deaths of all the co-authors, their inheritors become the copyright owners of the co-authorial work (Miladinovic, 2011).
- Co-authorship significantly influences the length of copyright, because if the case involves a co-authorial work whose length of protection is calculated based on the date of a co-author's death, the rule is that the relevant date of death is the date of death of the co-author who was the last to die.

Co-authorship is possible only if creative contributions of individual co-authors belong to the same kind of authorial creation (e.g. literature, music or painting). If the creative contributions of individual co-authors belong to different fields of authorial creation (e.g. one author creates a work in the field of music, and the other in the field of literature), then this not a co-authorial work, and the case involves combined works.

## **AUTHORS OF COMBINED WORKS**

A combined work implies an authorial work which was created by joining two or more independent authorial works, with the only goal being their joint exploitation. It is an illusion of a unique co-authorial work, because the whole that the joint works make is not indivisible.

Combined works differ from co-authorial works. When it comes to combined works, each work has its author and each of them keeps their individuality. “According to that, the community of the subjects of law that is created by merging of the works, originates not from the fact of mutual creation of a unique work, but in the legally valid expression of the desire of more authors to merge their works due to the needs of certain types of exploitation.” (Markovic & Popovic, 2013, 54).

Stemming from the fact that authorial works are joined based on the freely expressed desire stated in an agreement the community that thus comes to exist is not unbreakable and can be unmade at any time. In addition, the agreement for joining is similar to a co-partnership agreement, rather than authorial agreement, which is particularly significant when considering the form of the contract, as this contract can be made verbally (written form is not necessary) (Ljubojev & Varga, 2014).

A combined work is not a co-authorial work, therefore the authors of that work are not co-authors either. Combined works also differ from co-authorial works in that, most often (though that does not have to be the case), authorial works of different types are joined (music and lyrics, choreography and text, text and picture, music and picture, etc.), while co-authorship as a rule comes to exist by creation of an authorial work which belongs to the same type (literature, for example).

A combined work should be differentiated from collection works as well. A collection work is a work that was created by joining commissioned authorial works of a larger number of authors into one single whole. Such works are, for example, encyclopaedias, dictionaries, databases, etc. The ordering party of combined works is the subject who organizes and finances the creation of such a work, which is created by contributions of a larger number of authors.

## **CONCLUSIONS**

An author of a work is a person who has created an authorial work. The property of being an author cannot be transferred to another person, but certain privileges from subjective copyright can be assigned or transferred to another person, primarily through an contract, but also through inheritance, as well as directly through law.

A co-authorial work has to represent a whole, and the co-authors themselves have to have the idea of creating a certain work through a mutual intellectual endeavour. The contributions do not have to be of the same size or quality provided that they contain creative elements. In our law, the German concept of co-authorship is accepted, thus making creative cooperation and indivisibility of creative contributions the elements of the concept of a co-authorial work. The indivisibility of the whole of an authorial work means that contributions of individual co-authors cannot be used separately.

A combined work implies an authorial work which was created by joining two or more independent authorial works, with the only goal being their joint use. Combined works differ from co-authorial works. When it comes to combined works, each work has its author and each of them keeps their individuality. A combined work is not a co-authorial work, therefore the authors of that work are not co-authors either. Combined works also differ from co-authorial works in that most often (though that does not have to be the case) authorial works of different types are joined. A combined work should be differentiated from collection works as well. A collection work is a work that was created by joining commissioned authorial works of a larger number of authors into one single whole.

## REFERENCES

- Bainbridge D. (2007). *Intellectual Property*, Harlow.
- Bently, L. & Sherman, B. (2004). *Intellectual Property Law*, 2 ed. Oxford: Oxford University Press.
- Besarovic V. (2011). *Intelektualna svojina*, Beograd.
- Cornish, W. & Llewelyn, D. (2007). *Intellectual Property: Patents, Copyright, Trade Marks and Allied Rights*, 6 ed. London: Sweet & Maxwell.
- Cooper Dreyfuss R. C. & Pila J. (2018), *The Oxford Handbook of Intellectual Property Law*, , Oxford: Oxford University Press.
- Damnjanovic K., Maric, V. (2007). *Intelektualna svojina*, Beograd.
- Encyclopedia of Art, <http://www.visual-arts-cork.com/art-glossary-of-terms.htm>.
- Gliha, I. (2017). Pregled hrvatskog autorskopravnog poretka, u: Barbić, J. (ur.), *Zaštita intelektualnog vlasništva*, Hrvatska akademija znanosti i umjetnosti, Zagreb, 19 – 51.
- Gliha, I. (2002). Razvoj autorskog prava u Europskoj zajednici, u: Gavela, N., Alinčić, M., Hrabar, D., Gliha, I., Josipović, T., Korać, A., Baretić, M., N. S., *Europsko privatno pravo*, Zagreb.
- Goldstein P., Hugenholtz B. (2010). *International Copyright*, Oxford University Press.
- Lewinski S, (2008). *International Copyright Law and Policy*, Oxford University Press.
- Ljubojev N., Varga S. (2014). *Zaštita kompjuterskog program sa osnovama Autorskog i Patentnog prava*, Univerzitet u Novom Sadu, Tehnički fakultet „Mihajlo Pupin“, Zrenjanin.
- Ljubojev N. Kavalic M, Stanisavljev, S. (2018). Authorship as a Subject of Copyright, Proceedings of 9<sup>th</sup> International Conference “Textile Science & Economy IX”, Zrenjanin, Zrenjanin: Technical Faculty “Mihajlo Pupin” University of Novi Sad, November 6, 2018, 182-189.
- Markovic S. (2007). *Autorsko pravo i srodna prava*, Beograd.
- Markovic S., Popovic D. (2013). *Pravo intelektualne svojine*, Pravni fakultet Univerziteta u Beogradu, Beograd.
- Miladinovic Z. (2013). *Pravo intelektualne svojine*, Kragujevac.
- Milic D. (2009). *Komentar Zakona o autorskim i srodnim pravima, sa sudskom praksom i međunarodnim konvencijama i ugovorima*, Beograd.
- Ploman W., Hamilton E., Clark, L., (2000). *Copyright: Intellectual Property in the Information Age*, London.
- Terence P. (2000). *European Intellectual Property Law*, Ashgate, New York,.
- Zakon o autorskim i srodnim pravima („Sl. glasnik Republike Srbije”, br. 104/2009, 99/2011 i 119/2012).

## ANALYSIS OF THE IMPACT OF SINGLE PARAMETERS ON DEFORMATION CHARACTERISTICS OF STITCHES

Anita Milosavljević, V. Petrović, D. Joksimovic, M. Pesic, S. Sindelic

\*Faculty of technology Leskovac, University of Nis - the scholarship holder of the Ministry

\*Technical Faculty "Mihajlo Pupin", Zrenjanin,

Đure Đakovića BB, 23000 Zrenjanin

mail: [anita.milosavljevic@hotmail.com](mailto:anita.milosavljevic@hotmail.com)

### ABSTRACT

*The paper analyzes the Belissima pants from the sewing problem. The influence of sewing parameters on deformation characteristics of stitches on two materials was analyzed. Material that has been damaged and other materials with a small percentage of elastin. All trousers with all technological parameters of manufacture were observed. Then they were named for analysis of chain and grain points by using different needle numbers and longitudinal masses of fins. The aim of the paper is to investigate which long thread length and needle tracking and the sewing parameters themselves will lead us to the strongest stitches and which stitches are best for trousers, ie in which trousers the users will feel best without breaking the stitches at certain movements wearing trousers. In order to achieve the most reliable results and improvements in the quality of the stitch and the product itself, real samples or fabrics, as well as stitches used on the model for making with all the changes in the parameters during sewing, are in the regular production of pants were analyzed to improve the quality and determine the parameters for the deformation characteristics of the stitches. Two types of material were examined, which contained elastin and elastomer material, for the strength of the stitches of the side pants on the base.*

**Key words:** Stitches, sewing parameters, needle number, longitudinal mass, thread, stitch strength, deformation characteristics.

### INTRODUCTION

The strength and stretchability of sewing garments depends on a number of technical and technological parameters such as: the type of fabric, the type and fineness of the sewing thread, the sewing fineness, the type of seam, the sewing type, the sewing density, the tightening of the sewing thread when sewing the sewing sticks. The breaking strength of the fabric and the shear strength of the fabric on the shear directly affect the strength of the garment. The shear strength of the shear is the force needed to overcome friction between the threads of the base and the foot.

The mechanical properties of textile materials are directed to determining the strength by tensile force, pressure, bending, twisting, deformation in the action of force and other. The strength represents the resistance to completely breaking the links between the particles of the material, while the deformation is caused by stress. In this case, the elastic and plastic segments of deformation are especially important for textile materials.

### EXPERIMENTAL PART

Belissima pants were analyzed and the sewing problem appeared. All trousers with all technological parameters of manufacture were observed. Then they were named for analysis of chain and grain points by using different needle numbers and longitudinal masses of fins.

They then compared and determined the exact sewing parameters that affect the deformation characteristics of the seams on the model. The analysis of the results will show which long end of the needle and the needle track will lead us to the strongest seams and the best stitches for the trousers, or in which trousers the users will feel best without breaking the seams when using the trousers.



*Picture 1. Belissima model pants*

### **Characteristics of the material being examined**

Two types of fabrics were selected for the preparation of the stitches for testing. Material I was made of a mixture of polyester and cotton (67:33), while material II was made of cotton with 3% elastane (97: 3). These materials are usually used in regular production at Belissima, but there is more elastane material. The samples were prepared and the quality of the sewing pants, which are part of the Belissima production program, were tested, but no additional materials were examined, but only the quality of the seams, ie the grain and chain points and the longitudinal mass of the end. Figure 2 shows the used fabric for making samples.

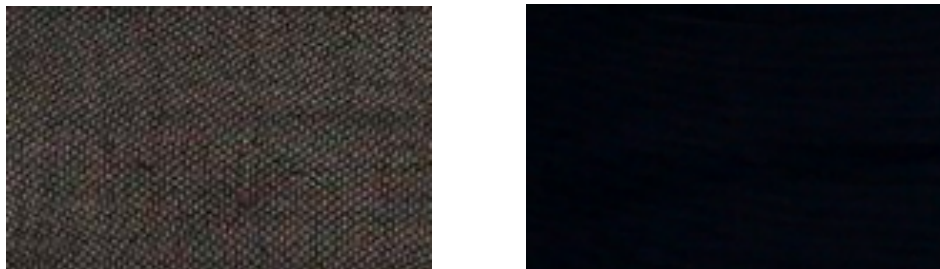

*Picture 2. Display of the used fabric from which sewing samples are tested*



## Characteristics of the stitch used for testing

*Table 1: Values of the examined stitch I - longitudinal thread Tex 10*

QUALITY CONTROL:		
No.	Rated quality characteristic (unit of measure)	Value obtained
1.	Raw material composition (%) POLYESTER	100
2.	Determination of longitudinal mass (tex)	20 (10x2)

*Tabela 2: Vrednosti ispitivanog konca II – podužne mase konca Tex 8*

QUALITY CONTROL:		
No.	Rated quality characteristic (unit of measure)	Value obtained
1.	Raw material composition (%) POLYESTER	100
2.	Determination of longitudinal mass (tex)	16 (8x2)

### Preparation of test samples

For the method of testing the breaking force and the interrupted elongation of the stitch weld, samples of fabric 70 mm in width and 150 mm in height are required. Two or more samples are placed one above the other face on the face or in some other order and then extend through the appropriate machine. The final shape of the sample is obtained when the closing edge of the fabric is close to the stitch, ensuring that the seam is not damaged so that the length of the seam remains 50 mm. After that, the thread that remained on the edge of the fabric near the seam should be adhered to the fabric so that the seam will not be paired. Prior to testing the sample, it is necessary to mark the line indicating the exact distance of the stitch to the clamp of the dynamometer in order to obtain the most accurate results. The distance from the stitch line is 100 mm.

For examination, stitches were prepared which were stitched and in the direction of the base and in the direction of the stream, first granular and then chain density density of 4 cm<sup>-1</sup>. In total, 96 samples were prepared - 48 of both fabrics. To achieve the best possible results, 16 combinations were made for both materials. It was made with granular and with a chain wheel. During sewing, 2 longitudinal ends of the end and 2 needles were used. The same sample was tested for each combination.

The samples were stitched with needles of numbers 80 and 90. The sewing thread of the longitudinal mass 20 tex and 16 tex was used for sewing the samples needed for interrupting the stitches. Some fabrics are welded with stitching type 1.01.03 and type 301. The point density applied was 4 cm<sup>-1</sup>. The samples were prepared by sewing the stitches both in the direction of the base and in the direction of the stream. Thus, the stitches samples represented the real seams used to make pants that were analyzed. The strength of the stitch on the side of the trousers was tested both on the basis and on the course. Stitches with granular and chain points were examined. In doing so, he wanted to explore which type of point is more robust.

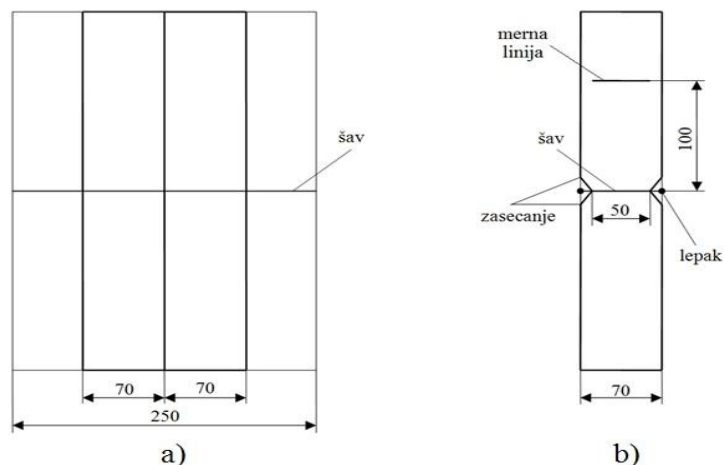

**Picture 3:** A schematic representation of the sample preparation for testing the strength of the stitch weld

### Machines and devices for the fabrication and testing of seam samples

The machines and devices used for the preparation and testing of samples are:

- ❖ A quick sewing machine brand Juki
- ❖ A quick sewing machine brand Siruba
- ❖ Dynamometer Mesdan S.p.A – Tenso Lab

The technical specifications of the machine are:

- stabs - grain sticks type 301 - maximum length of the stitch 5mm
- lower and upper transport
- Raising the stomach up to 13mm
- automatic cutting of the stitch
- sewing machine speed - 4,500 ppm \*



**Picture 4:** Common sewing machine Juki - joining samples



*Picture 5: Common fast sewing machine Juki - patterning - forming stitch*

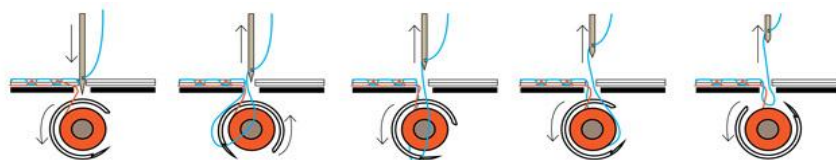

*Picture 6. Formation of machine sting 301*

### CONVEYING THE END THROUGH MATERIAL

The thread, inserted into the needle's eye, is threaded through the material that is stitched in shape. In the beginning, the thread does not move in the needle eye, and then moves through the needle as shown in Figure 23. This works by the specified tensile force by the  $T_b$  stitch and thread stitch  $T_d$ .

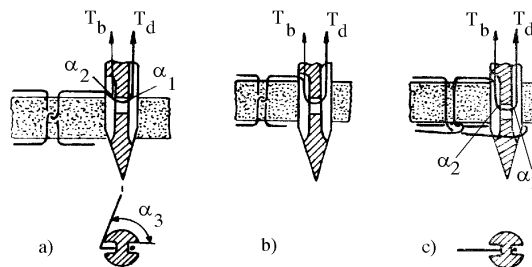

*Picture 7. Spinning the needle thread through the sewing material*

## OBTAINED RESULTS OF THE EXAMINATION

Based on the examination of samples, trousers, the results of the effect of force on the damage of stitches were obtained, depending on the applied fabric, the thickness of the end, the needle type of the sewing type type and the type of machines on which the sewing was done. Two materials and a quality of the grain and chain points were examined in the direction of the base and the weft, in order to determine which points are better for a higher quality, elastic and durable seam. Based on the test, the following results were obtained which were shown and compared to the histograms below.

### Histogram of seam strength and elongation at grain and chain points

The following histograms simultaneously show the comparison and maximum seams strength and the greatest elongation in granular and chain points on material I and material II.

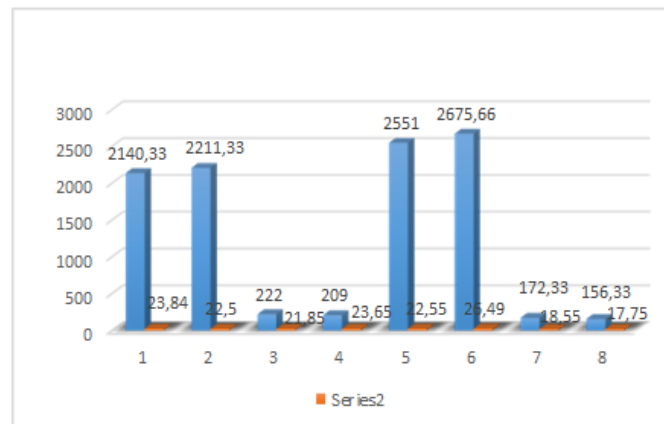

**Picture 8.**

**Picture 8.** a common histogram of the greatest elongations and severity of sewing bursts is shown in the needle pocket 80 and the longitudinal weight of the end 20 tex and 16 tex on the material I.

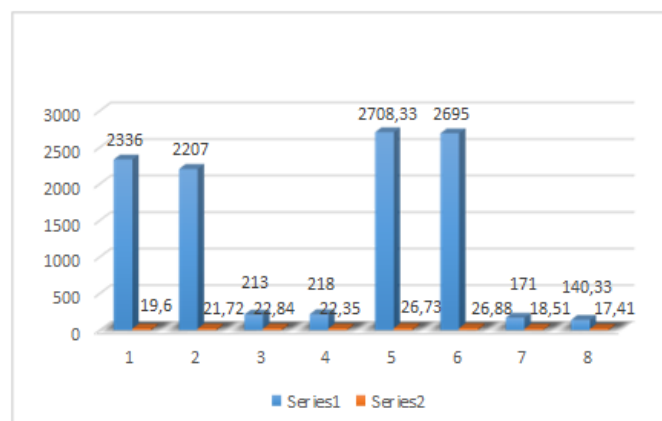

**Picture 9.**

**Picture 9.** shows a common histogram of the greatest elongations and severity of sewing at the needle 90 and the length end 20 tex and 16 tex on the material I.

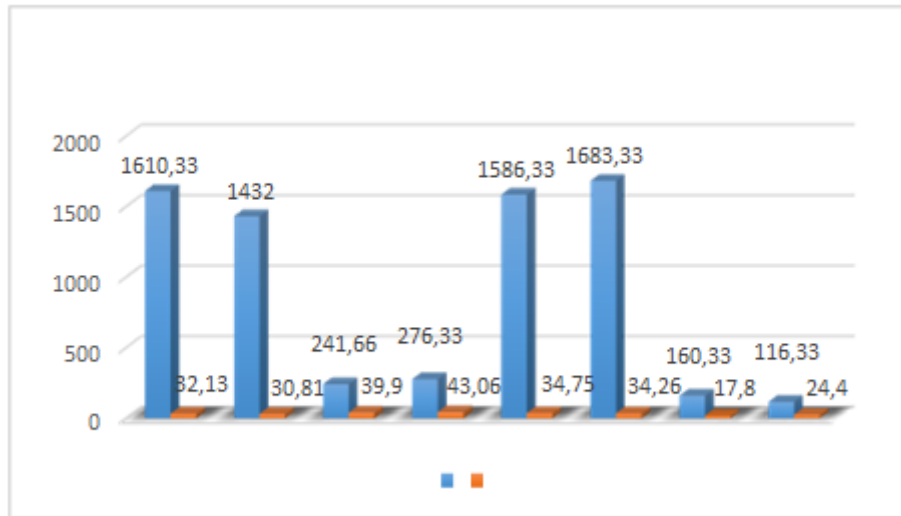

**Picture 10.**

**Picture 10.** a common histogram of the greatest elongations and severity of sewing bursts is shown in the needle pocket 80 and the longitudinal weight of the end 20 tex and 16 tex on the material II.

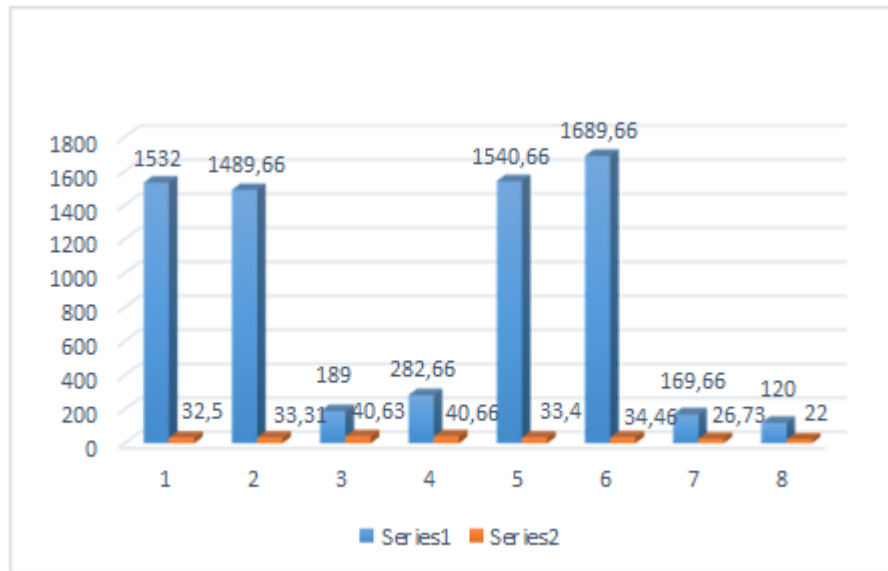

**Picture 11.**

**Picture 11.** a common histogram of the greatest elongations and severity of sewing bursts is shown at the needle number 90 and the longitudinal weight of the end 20 tex and 16 tex on the material II.

The consequences of damage to the stitches can be seen from the degree of disruption of their construction. Damage is visible when the stitch is broken, due to the compaction of the connecting points of the material crosswise to the stitch and the simultaneous stretching of the sewing thread, the shearing of the thread in the sewing area of the sewing, which is caused by the sewing of a sewing thread, fabric or bursting of the seam itself.

Data processing has shown which type of strap is durable on fabrics. Also, the causes that resulted in more frequent damage and breakdown of stitches.

Taking samples with a thin needle and a thicker end, a thin needle and a thinner end, and vice versa, on the base and on the foot, with a grain and chain point, leads to new proposals and the quality of the stitches. The ends of the longitudinal mass 20 tex and 16 tex and the needle numbers 80 and 90 were used. For the production of both stitches, a density of 4 cm-1 was used.

By comparing the results with the material I, the seam made in the base direction, the chain point, but also the granular point, the longitudinal weight of the end of 20 tex and the needle of the track 90 proved to be the most robust. To this stitch, the quality of the end, ie the end of the median longitudinal mass, has been brought, and the needle is suitable for that longitudinal mass of the stitch. In this case, the needle does not cause material damage to the material and the stitch is thus stronger and durable, which can be recommended for manufacture.

In some samples, the granular point turned out to be stronger in comparison with the chain point, to which the quality of the material was combined with the larger longitudinal end of the end, but with the use of the end of a stronger longitudinal mass and the chain of the material with the elastin, it led to high chain points and to their the great elongation and the quality of the seams as the results show. The chain point has a greater elasticity everywhere, making the stitches more durable and in the base and in the subway direction.

For material II, the results showed the same as for material I, as regards quality and point selection. In the case of a grained point, the problem arose in the case of a thin needle, a needle of a track of 80, and a longitudinal mass of the end of 20 tex. According to all results, a chain point in the direction of the stream is recommended to achieve a better quality of stitch in material II. It is recommended to manufacture a longitudinal teeth of end 16 tex, and a needle pin number 80, where the elongation is as high as 43mm, at the base, the longitudinal weight of the end 16 tex and the needle number 90.

For the tested model, a granular scarf and a cloth without elastane were used. It is proposed to work with materials with elastane and chain point and with changing the length of the stitch of the end and the number of needles. This is indicated by a better result achieved, that is, the seam on the material with the elastin (the longitudinal mass of the used end 16 tex, and the used needles of the track 80), where the elongation is reached 43.06 mm. Such elongation has a satisfactory strength or high elasticity compared to the same stitch made of a granular point on a material without elastin. The results of this paper have shown that the quality of the stitch can be improved by changing the grain in the chain point using materials with elastin and careful combinations of the needle number and the length end of the end.

## CONCLUSION

Based on the sewing parameters affecting the deformation characteristics of the stitches, we can conclude on the basis of the obtained results in the exact load, there is damage and cracking of the stitches on the pants as well as what are the causes of it.

In some places, the greater the strength of the grain points compared to the chain point, it brought the quality of the material in combination with the larger longitudinal end of the end, but with the use of the end of the stronger longitudinal mass and chain bar on the material with elastin, a high chain strength and their high elongation and quality stitches.

The larger stretching force makes the stitch more durable and such a stitch is more advisable due to its elasticity, which leads to damage to the stitch during straining.

In this work, new conditions are proposed: sewing of these two types of stitches and chain points, as well as the use of fabric with a lower percentage of elastane.

We obtained a better result and this is a stitch on elastin material made with chainsaw (longitudinal mass of the used end 16 tex, needle pins 80, elongation 43.06 mm). It has a satisfactory interrupting force and high elasticity compared to the same stitch made of granular point on a material without elastics, especially if we take into account that the interrupting forces and the interrupted elongation of the seam seam is based on measurements of the elongation force at its constant one-way load. This stitch is distinguished for the greatest elongation, while in the work itself, especially in the discussion of the results, the elongation and strength of all stitches are shown.

The results of the sewing parameters test, intermittent elongation show that the quality of the stitch can be improved by changing the grained in the chain point, using elastin materials with greater interruptions and careful combinations of the needle and the longitudinal end of the end to which new proposed conditions have been introduced.

## LITERATURE

- [1] A. Kunštek, B. Knez: Damage to seams on clothes, *Textile - Zagreb*, 35 (1986) 6, 389-402
- [2] U. Schmid, J. Mecheels: Kräfte an Textilien und Nähte der Kleidung in Abhängigkeit von Körperbewegungen und Kleidungsschnitt, *Bekleidung + Wäsche*, 33 (1981) 2, 77-82
- [3] В. Ф. Шаньгина: Структурная схема показателей качества соединений деталей одежды, *Технология легкой промышленности - Москва*, 26 (1983) 2, 113-117
- [4] Е. Б. Коблякова: Структурная схема показателей определяющих уровень качества одежды, *Швейная промышленность - Москва*, (1976) 2, 10-11, (1976) 3, 21-24
- [5] D. Rogale. D. Ujević, S. F. Rogale. M. Hrastinski: *Procesi proizvodnje odjeće*, Zagreb, Tekstilno - tehnološki fakultet Sveučilišta u Zagrebu, 2011
- [6] PIRIN-TEX EOOD-Quality made in Bulgaria/EU- ROLLMANN – Brošura kompanije, 2016.
- [7] V.Petrović, M.Gašović: Fashion collection, Technical faculty "Mihajlo Pupin", Zrenjanin, 2016., ISBN 978-86-7672-257-0, COBISS.SR-ID 299045383

**Acknowledgment:** This paper is a part of the research project No. TR – 34020, financed by the Ministry of Education, Science and Technological Development of the Republic of Serbia. We thank the Ministry for financial assistance.



---

**STUDENT WORKS**

---



## "TECHNOLOGY OF MAKING DRESSES WITH ETHNO MOTIVES"

Milica Stojanović, V. Petrović, A. Milosavljević, D. Joksimović, M. Pesic

Technical Faculty "Mihajlo Pupin", Zrenjanin - Đure Đakovića bb, 23000 Zrenjanin

e-mail: [stojanovic.milica407@gmail.com](mailto:stojanovic.milica407@gmail.com)

### APSTRAKT

*Ethnic influence revives craft skills from the past and the furthest places. Many famous designers take ethno motives as an inspiration for their collections.*

*Modern tailors are proving this motive in creating something new. The purpose is that this new looks looks original, different and modern. Ethno motif refreshes today's fashion and stands out with strangeness. Ethno culture is revived in this way, which is also very importantly used on the world fashion catwalks. Serbia is a country rich in tradition and ethno culture and it would be a shame to forget and not use it.*

**Key words:** tradition, ethno motives, modern clothes.

### INTRODUCTION

Clothing is a necessary part of human life in terms of its protection and survival. Thanks to the clothes, a man can live in different climatic conditions. The clothes also have a very important aesthetic function, and with it people beautify their body and conceal some physical defects.

The clothes changed many times through history. Regardless of the change, she often turned around in the circle through these changes, and some clothing items, such as the 1970s, returned to fashion again with some changes.

What is very important for every country is history. Serbian folk costume occupies a prominent place in the culture and tradition of the Serbian people. Her role through history is very important as a symbol of ethnic identity, and it is also emphasized in visual and aesthetic values. To date, there have been mostly preserved garments from the 19th and the first decade of the 20th century, with varied forms and decorations in both women's and men's wear.

The national costume is now ejected from everyday use, although it was a long time ago worn on a daily basis. However, the fact that traditional Serbian costume is not worn today, except on some special occasions where Serbia should show its tradition at its disposal, people from the fashion world have made efforts to make some ethnic pieces modern and daily wearing.

### INSPIRATION

My idea was to show several models of modern fashion dresses with ethnic motifs and in that way I show that no matter what costume is not so represented today in everyday wear, some of its parts, ornaments and patterns can be used in the modern industry, and they look beautiful and modern.

I found the inspiration in the traditional connection from Ukraine and female zubun, it is actually an upper dress for women with short sleeves or without sleeves, decorated with folk laces. There are many different dental patterns. I decided to have one from Bukovica. The inspiration is shown in the picture below.



*Picture 1: Inspiration for dresses: female zubun, Ukrainian traditional embroidery, a model that inspired me, hairstyles and shoes*

Below are the fashion sketches and their fashion drawings. Under the fashion sketch is meant a graphic representation of the front, rear and, if necessary, the lateral part.



*Picture 2: Fashion drawing and technical sketch of dresses with ethnic motifs of female zubun*



*Picture 3: Fashion drawing and technical sketch of dresses with ethnic motifs of female zubun*



*Picture 4: Fashion drawing and technical sketch of dresses with ethnic motifs of female zubun*



*Picture 5: Fashion drawing and technical sketch of dresses with ethnic motifs of female zubun*

### **CONSTRUCTION PREPARATION**

Construction preparation, as part of the overall technical preparation in the production of clothing, has a very complex and responsible role, and the tasks it deals with are very demanding. The final result of all preparations should be quality, accurate and in line with technical and technological capabilities and requirements. It is also necessary to prepare a garment for the production process in time. [1]

The picture shows a fashion drawing and a technical sketch of the model for which the construction was made



*Picture 6: Fashion drawing and technical sketch of the dress inspired by traditional connection from Ukraine and female zubun*

The construction of the dress requires the size of the dress and its main and auxiliary measures.

Body dimensions are taken from the table of measures prescribed by standards (industrial production) or on the basis of measurements of certain parts on the body (craft production). For model 5. I calculated the measures through the table of prescribed standards;

**Size designation 40**

**Main dimensions:**

**Bh** Body height = 168 cm,

**Cc** Chest circumference = 92 cm,

**Ws** Waist size = 74 cm,

**Hs** Hips size = 98 cm.

**Auxiliary measures:**

**Dw** The depth of the weapon = 20,70 cm,  $1/10 Og + 10,5 \text{ cm} + 1 \text{ cm}$

**Lb** The length of the back = 41 cm,  $1/4 Tv - 1 \text{ cm}$

**Hh** Height of the hips = 63 cm,  $3/8 Tv$

**Cl** Cutting length = 90 cm,  $5/8 Tv$

**Wn** Width of neckline = 6,60 cm,  $1/20 Og + 2 \text{ cm}$

**Hfp** Height of front part = 45,10 cm,  $Dl + 1/20 Og - 0,5 \text{ cm}$

**Wb** The width of the back = 17,40 cm,  $1/8 Og + 5,5 \text{ cm} + 0,5 \text{ do } 1 \text{ cm}$

**Was** Width around the sleeves = 11,70 cm,  $1/ Og - 1,5 \text{ cm} + 1,5 \text{ do } 2 \text{ cm}$

**Bw** Breast width = 20,50 cm,  $1/4 Og - 4 \text{ cm} + 1,5 \text{ cm}$

**Wb + Was + Bw** = 49,50 cm,  $1/2 Og + 3,5 \text{ do } 4,5 \text{ cm}$

**Ww** Width of waist = 17,50 cm,  $1/4 Os - 1 \text{ cm}$  [2]

**Basic dress construction**

On the basis of the given measures, the basic construction is made, so we can say that the design is the design of parts of a garment. The basic construction does not have to be made again, but it is used the same for different models of dresses so that the next model of a relatively similar cut should not be re-constructed, but certain procedures and corrections are made on the basis of the existing tailoring.

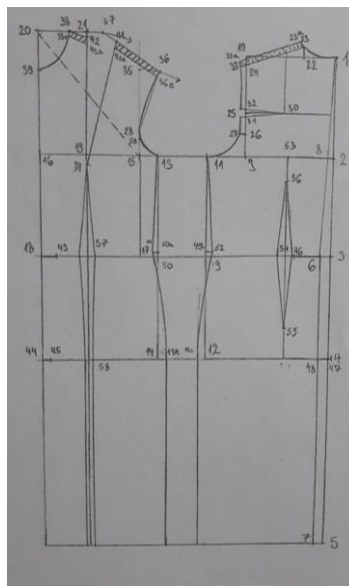

Picture 7: Basic construction

## Modeling the dress

Modeling involves the process of moving seams and various seams, determining new seams on various cuts, adding folds, falts, various accessories for bell-shaped forms. In order to check whether the new modeled garment in accordance with the changes made is done well, a trial model is produced, the so-called test sample, which is tried on a model the size of which corresponds to the size of the garment.

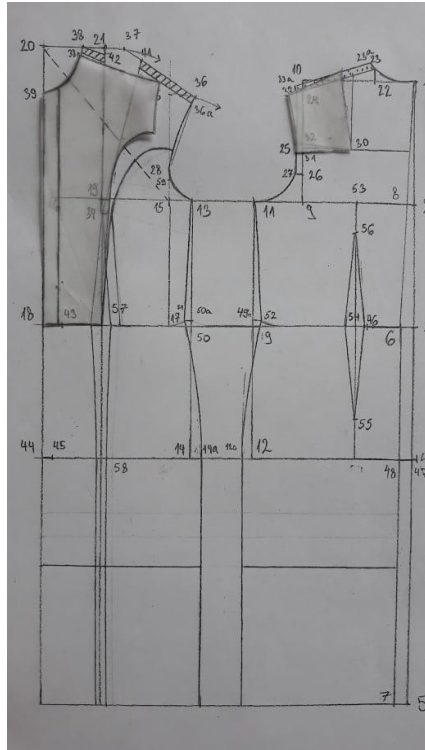

*Picture 8: Modeling the dress*

## Completing the dress

Completing involves adding seams to those places where they are not added during the construction. It is done in order not to reduce the garment after sewing. In women's clothes, seams are added to the whole scope of construction.

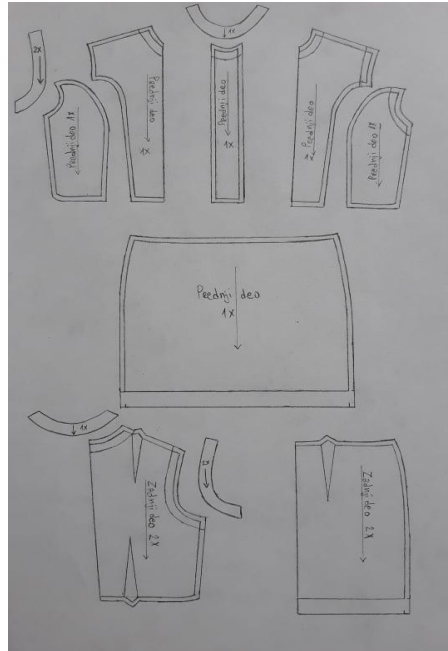

*Picture 9: Completing the dress*

## Making a cut image for a dress

The attachment of cut images is the stage of preparing garment production, in which the cut pieces fit into the predetermined width of the material. The shape of the cut-off parts depends on the model and the size, and it is very important that as soon as the fittings are fitted, the material is as small as possible, and that they fit in as precisely as possible.

Two-way fit

Size 1: 6

Drawing length: 100 cm

Image size: 114 cm

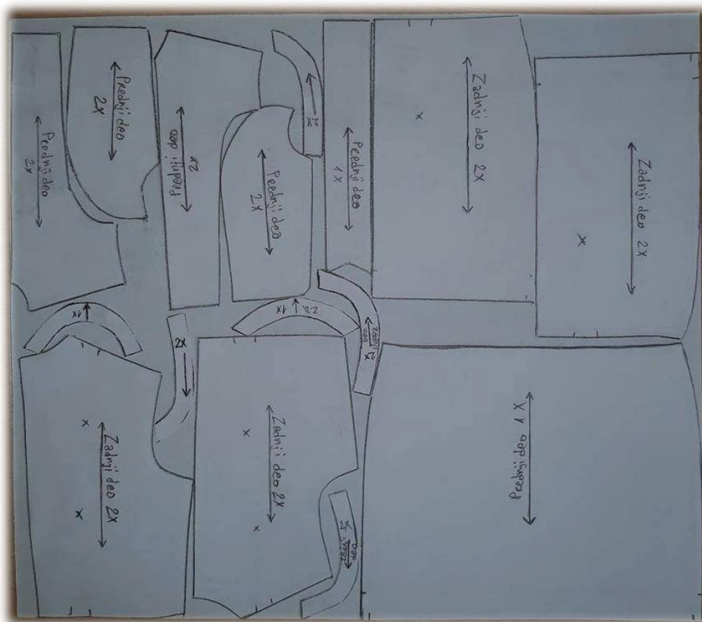

*Picture 10: Making a cut image for a dress*

## CONCLUSION

The basis of ethnic style in clothes is a harmony with the self and the world around you. Therefore, natural comfortable fabrics and styles that do not restrict movement are used. The clothes are decorated with embroidery, apparel and other decorative elements. The accessories are also made of natural materials: wood, ends, shells, bones. Now many similar products are sold in online stores, because there you can find the right shoes and bags that will complement the image.

Ethno is exotics, self-expression, naturalness and originality. That is why this style is especially popular among creative people and free spirit. Ethnic style in clothes is not just repetition of national motives, but the opportunity to express and show imagination and good taste.

## LITERATURE

[1] Processes of garment production. Prof. dr. sc. Dubravko Rogale, prof. dr. sc. Darko Ujević, doc. dr. sc. Snježana Firšt Rogale, Marijan Hrastinski . prof. Savj. Zagreb, October 2011.

[2] Techniques of designing and modeling of clothes, TEXTILE - TECHNOLOGICAL FACULTY, Zrinski d.d., ČAKOVEC, ZAGREB, 2010, Darko Ujević, Dubravka Rogale, Marijan Hrastinski



## NATIONAL COSTUMES OF UŽICE REGION

Jelena Đukić, V. Petrovic, D. Joksimovic, A. Milosavljevic, M. Pesic, S. Sindjelic

Technical Faculty "Mihajlo Pupin", Zrenjanin,

Đure Đakovića bb, 23000 Zrenjanin

e-mail: [jelenadjukic09@gmail.com](mailto:jelenadjukic09@gmail.com)

### ABSTRACT

*Clothing population of an area is often characteristic of the environment that's settled, a reflection of economic and social status of the population, as well as way of adapting to climate conditions. Traces of historical events and influences of other cultures can be found in national costumes. It is also the reflection of art and creative range of a nation.*

**Keywords:** national costumes, western Serbia, Užice region

### 1. INTRODUCTION

Analyzing the main parts of Užice region costume from XIX and XX century, we find analogous connections with the area of Montenegro, Herzegovina, Bosnia, Polimlje, Old Raška, where most of the population of this part of western Serbia, known as Old Vlach is originated. However, in the manner of dress and appearance and in terminology of individual garments, there can be found many elements of Oriental culture, especially to the middle of the XIX century (fez, jamadan, vest, pants poturlije).

Given that this part of western Serbia is mostly mountainous and that the cattle breeding was an important industry during the XIX century all up to 1960's, it also had an impact on the development and costumes appearance.

Costumes of the area belong to the Dinar mountain-type containing strictly default forms of basic, mostly clothing elements made from heavy cloth, wool, and in a lesser extent of hemp (weight), flax (ćeten) and cotton. These costumes were produced as homecrafts (by women) or by individual craftsmen (furrier, tailor).

### 2. NATIONAL COSTUMES

At the time when the heavy cloth was extensively used for producing clothes, every rural household produced it in sufficient quantities for personal use. Heavy cloth was in white, black "crow" and dark brown "singava" colour. Final finishing of heavy cloth was carried out in the valjarica (valjarica).

Mainly overall smocks "haljetci" worn in winter time (gunj, pelengiri, zubun, jeleci).

#### 2.1. Formal suite

Formal suite, worn as part of a bridal costume, at fairs, celebrations, were decorated with braids, black wool embroidery (vranovez), red wool (krmezvez), braid embroidery, spangles, beads, silver threads, and other. Considering quite stiff material for applying embroidery, threads did not went through textile so the ornament was performed by placing braids, threads, strips onto the textile and then sewn with silk or cotton thread. Ornament was performed by drawing.

To achieve extreme plasticity of detail and expressive decoration, fine embroidery was put over the previous coarser embroidery, or shoved hard paper, cardboard, cotton balls. The ornaments were mostly geometric or vegetable stylized.



Figure 4: Female and male peasant costume, 1910 year, Užice

## 2.2. Women's clothing

Women and girls wore a long shirt sew with hemp, or flax, and for the holidays with half-cotton linen. Shirts consisted of front and rear "stana"- "pole" and inserted "spikes"- "klinova" which expanded the skirt chemise of shirts.

Often around the neck, along the bodice decolletage ("usprsnica"), along the sleeves bottom were embroidered. Ornament was in form of geometrized floral guide line made of "rose" leaves and twigs. Embroidery was mainly made out of wool or cotton thread red, blue or black color with cross stitch "pokrstica". Edges of sleeves and their bottoms some times were decorated with lace ("rešma", "čimka"), made by crocheting out of hem, flax or cotton thread. In addition to long shirt, which were kept in use by older women, there is a change in the period between two world wars.



Figure 5. Women shirt

Over shirt in the summer and over skirt in the winter, the front narrow rectangular, single-pole "prežina" or "pregača" apron was tied, woven of fine wool, decorated with woven patterns and stripes, while the apron was worn on special occasions (fairs, celebrations) or as part of the bridal accessories which were decorated with silver or gold woven strands of sterling silver and embroidery. Between the two World Wars, minor changes are starting, and the younger population instead of the narrow apron is wearing "kecelje" sewn from purchased satin, linen. Often they were decorated with embroidery and "karnerčići" (plant designs).



Figure 6. "Prežina" or "pregača"

Belts that were worn around the waist, over the shirts in the summer, over the skirts in the winter, were woven from colorful wool. The ornaments were in the form of narrow stripes, small diamonds, dashes, crosses. There were especially decorated and embroidered festive belts that were buckled with "pafta" (clasps). These decorative buckles were made in the technique of casting and hammering, and they were the product of craftsmen silversmith. In winter, long wool skirts worn, a rich pleated and long till the ankles often embroidered at the bottom in the form of the flower "vođice".



Figure 7. Belt and "pafta"

Every day in the summer and winter and especially at holidays, were worn hemp, wool or cloth "psluk" also known as a waistcoat, a smock overall without sleeves, short, with deeper neck on the chest and was buckled with "kovče" and "petlje". Borders of the vest, especially a holiday vest, were decorated with wool braids in several rows, and at families in better standings were worn bodices with silk cords decorated with sterling silver cords or gold and silver threads.



Figure 8. "Jelek"

In the winter and in cooler weather as well as in special occasions (as part of the bridal accessories) women and girls are dressed in a shirt, a waistcoat "jelek" and hemo jacket without sleeves with an opening over the entire front length, known as the "zubun". It is considered one of the oldest elements of clothing among the South Slavs in Balkan region. As a rule it was tailored of white cloth. It consisted of three parts (back and two front aprons) with bolts inserted from the side of the back and the front parts. They could be longer or shorter.

The surfaces were decorated with embroidery ("vranovez", "krmezvez"). In addition to colored wool embroidery is made of sterling silver thread, beads, sequins "šljoke", "sjanice", and sometimes purchased lace was sewed on the edge. "Zubuni" were mainly decorated by craftsmen-tailors. After 30's of the twentieth century, its use is decreasing.



Figure 9. Zubun



Figure 10. Women's national costume

### 2.3. Men's clothing

In the nineteenth century men's clothing in this area, the shirt was a basic smock overall worn in summer and winter. It was made out from heavy or cotton cloth. Considering the cut, it belonged to the type of Dinar region. Festive ahirts were decorated with floral embroidery-vine, through kolijer, along the cut at the chest. Around the waist was girded woven woolen colorful wider and longer belt.

Particular feature of the rural male costume of this region in the nineteenth century were "pelengaće" or "pelengiri"-pants with wider bottom and wider legs that reached below the knee. Carried in the winter time, home-made by a woman of wool material in black or "singava" color. In addition to "pelengira" in use were trousers in white or black ("vrana") color. Carried till the post World War II when "pelengiri" and hemp pants were replaced with a military cut "pants", sewed from purchased cloth "čoja".



Figure 11. "Pelengiri"

Upper peaces of clothings that are worn over a shirt were mostly sewed from home-made cloth that in the long term represented basic and most important fabric for making warm items of clothing.

Broadest application had the bodice that was otherwise known by the name "gunjić", "zubunić". Worn throughout the year, in the summer over the shirt, in the winter over a "gunj". Opened in full-length, it was reaching till the waist. It was often decorated with wool braids in multiple rows.



Figure 12. "Zubunić"

The main winter smock overall tunic top with long sleeves that almost everyone had worn was jerkin. They were made of "singave" or "vrane" colored cloth. It reached to the lower back, and the front sides were overlapping. The sleeves at the bottom were cut open and they were buttoned with buckles and small buttons. The edges were decorated with two to three rows of black woolen braid. Dark blues or black cloth jerkin was worn in formal occasions and between wealthy people, also "fermen" was worn of the same material and color. They were decorated with silk cords and black "bućma". Jerkin and "fermen" are representing most beautiful parts of the holiday suits, which were made by artisans-tailor.

### 2.3. Covering the head

Covering the head had a special significance, except for protection from bad weather and sun, often was a sign of economic and social status. Girls in this region wore with-headed braids around their head, and on holidays red caps or small "ves" with a black tassel. Women were usually covering their heads with scarf ("šamija") from domestic or industrial produced fabric, as part of brides head-dress in addition to needles that were used to attach cap and braid (with head pins), worn close to head-part and scarf with silver jewelry in leaf-like form called "liska" or "čelenka".

As for the head-dress for men, in addition to fez (vez) - red cloth cap with black tassel, in the winter was worn conical shape winter cap "šubara". It was made of black lamb fur, or knitted black wool. It was worn with a little depressed tip. After the Serbo-Turkish war in the 1878th year, folk hat "šajkača" cap with double sides is introduced. It is usually made from cloth and olive-gray factory cloth and younger people were first to start wearing it, and then the elder. In winter, around "šubara", or "šajkača" often is wrapped woven red or white woolen scarf. In the summer months straw hats are worn.



Figure 13. Šajkača

### 2.3. Footwear

In addition to covering the head and upper parts of the body with clothing to protect from cold and injuries, a man had a need to protect the feet. At Užice region depending on material of which they were made, shoes can be divided into soft and hard.

Soft shoes included stockings, "nazuvice", "priglavci" and "tozluci". They were made mostly of wool in homecraft. Socks were common to both women and men except that men's were long to the knees, and female slightly shorter. Socks that are worn on ceremonial occasions (fairs, weddings) were decorated with knitted patterns (geometric and plant designs). Socks are worn under the "nazuvice". Men wore the "tozluke"-leggings made of cloth, usually black. In summer they were worn with shirts and long pants, and in winter with pelengire. They covered the legs from ankles to knees, and on the sides they had metal clasps. Their way of wearing was different. While with the pelengire they were worn under trousers, but with shirts-above the leggings of long pants.



Figure 14. Socks and "tozluci"

Hard shoes are represented primarily by peasant shoes "opanak". They were worn by both men and women. They were light shoes made from leather or rubber, wrapped around a foot with belts, "oputa". Peasant shoes "djonovi" were made of well-manufactured leather. "Djonovi" with deeper sides had shoe-tips bent towards the leg. Wider cut belts for fastening them around the foot were typical for Užice region. After World War II a rubber "opanci piroćani" were introduced.



Figure 15. "Opanci" and "piroćani"



*Figure 16. Men's national costume*

### **3. CONCLUSION**

Finally we can say that in terms of economic development, improvement of transport links increasingly caused the losing of old way of dressing, and new forms of clothing were adopted. It first appears in younger population and in the villages that were closer to urban centers where new influences were coming from. While the young quickly move on to new forms of clothing, the older ones for some time along with the new fashion kept in use parts of old costumes. In this way some women's handicrafts in some details became part of the urban environment of modern consumer society. That should reflect the reincarnation of timeless values of national spirit and creativity of the people of this region.



*Figure 17. Women's and men's national costume*

#### **4. LITERATURE**

- [1] <http://slobodnahercegovina.com/narodna-nosnja-zubun>
- [2] <http://www.opanak.net/sumadijska-narodna-nosnja-delovi-narodne-nosnje/>
- [3] <http://kudsevojno.com/sr/NarodnaNosnja>
- [4] <http://www.zavicaj.info/wp-content/uploads/2012/12/katalog.pdf>
- [5] <https://sr.wikipedia.org/wiki/%D0%A8%D0%B0%D1%98%D0%BA%D0%B0%D1%87%D0%B0>
- [6] <https://sr.wikipedia.org/wiki/%D0%9F%D1%80%D1%81%D0%BB%D1%83%D0%BA>
- [7] <https://sr.wikipedia.org/wiki/%D0%A7%D0%B0%D0%BA%D1%88%D0%B8%D1%80%D0%B5>
- [8] <https://sr.wikipedia.org/wiki/%D0%9E%D0%BF%D0%B0%D0%BD%D0%B0%D0%BA>



## Application of textile materials in the **AUTOMOTIVE INDUSTRY**

Jovan Radisic, Vasilije Petrovic, D. Joksimovic, A. Milosavljevic, S. Sindelic, \*J. Stepanovic

\*Technical Faculty "Mihajlo Pupin", Zrenjanin, - Đure Đakovića bb, 23000 Zrenjanin

\*Faculty of Technology Leskovac, University of Nis - The scholarship holder of the Ministry  
email: [j.radisic98@hotmail.com](mailto:j.radisic98@hotmail.com)

### **ABSTRACT**

*One of the most valuable fields in which technical textiles are used is the automotive industry. The advancement of the textile industry in the automotive industry has made significant improvements in the design and quality of the product. This implies that quality and product design considerably affect the sales of the car itself. Textile has partial application in the automotive industry. The first part deals with the research of what the carmakers demand from textiles. The second part deals with the construction of a car interior. The third part works on safety such as airbags and tires. The fourth part is researching where all textiles can be incorporated into the bodywork.*

**Keywords:** Car, Textile, Car industry

### **1. INTRODUCTION**

Since humanity exists, textile materials are used for different purposes. Most people think that textiles are used only for clothing, but there are other types of textile materials that are not used for clothing. One of these types is technical textiles. Automotive textiles are part of technical textiles. We can't punch him in clothes, but about 50 square meters of textile material is used by the car. Automotive industry produces everything from light vehicles to heavy-duty trucks. Textile is used in all these vehicles. In the automotive industry, textiles are used for seat covers, such as upholstery for doors, carpets, tires, steering wheels ... In addition to the automotive industry, technical textiles are also used on ships, on planes and in trains.

### **2. INDUSTRY INSIGHTS**

The global market value of the car was about 23.82 billion US dollars. The global growth of the market is expected to be generated by car production in Asian countries such as China, Indonesia, Thailand, India. In addition, it is expected that increased penetration of technical textiles in the automotive industry to supply high-quality applications will trigger global demand.

It is expected that the growth of car production and favorable safety regulations will trigger growth. Other factors, such as accelerated urbanization and industrialization in the developing economies of China and India, are expected to be witnessing significant growth in the next eight years. This growing trend in automotive textile applications offers wide opportunities for industry participants.

It is assumed that research and development initiatives for the development of new textile products, as well as top-level textile products, have a positive impact on the growth of the market. On the regulatory plane, it is anticipated that directives relating to safety standards and emission control have a critical impact on the global market.

It is assumed that many regulations related to passenger safety are fueled by demand for automotive textiles for the production of airbags and seat belts. The standard Euro VI standard for petrol and diesel, which regulate heavy and light vehicles, is expected to increase the use of textiles in automotive filters. The global size of the automotive textile market was \$ 23.82 billion.

Automotive textiles are a part of technical textiles and are widely used in the automotive industry. Automotive textiles are mainly used for the interior of the car. Manufacturers have been taking active steps to improve their product portfolio and develop superior products to cater to the growing demand. Emerging regions such as Asia Pacific and Central & South America offer ample opportunities for the industry participants. R&D initiatives to develop superior quality textile as per the consumers need offer ample opportunities for the existing as well as new industry participants.

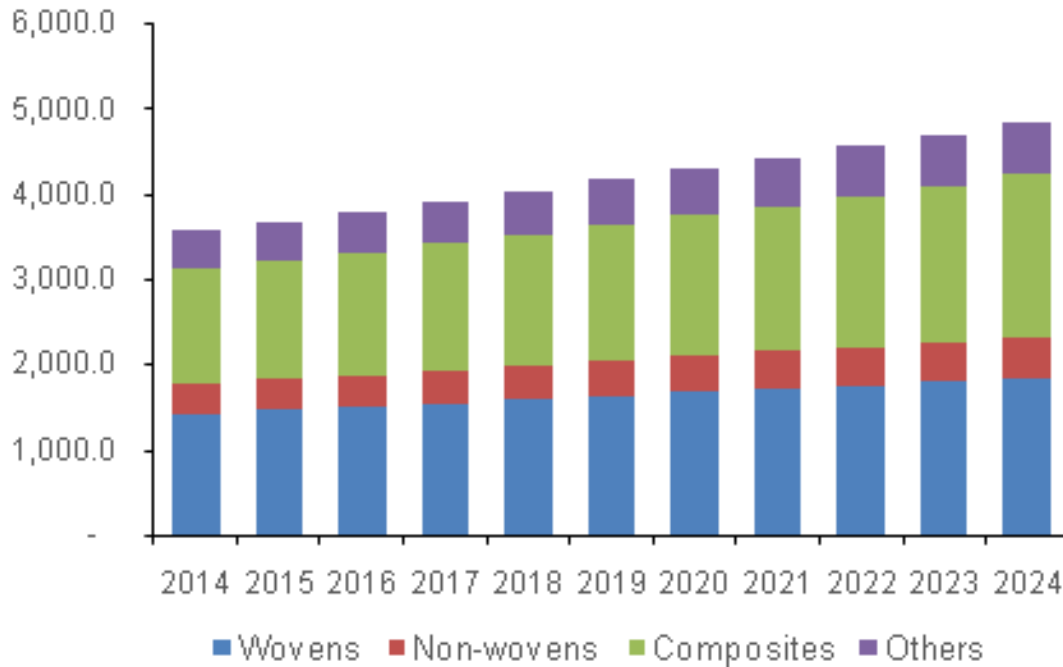

Photo 1: U.S. automotive textiles market revenue by product, 2014 - 2024 (USD Million)

### 3. AUTOMOTIVE TEXTILE COMPONENTS

The textile fibers used in various components of an automobile are given in Table 1.

Table 1 : Textile fibers used in various components in an automobile	
Applications	Fibers used
Seat belt	Polyester
Airbag and headliners	Nylon
Body cloth	Polyester, nylon or their blend
Interior carpet	Nylon
Package trays	PP and nylon
Door trim	PP, nylon, polyester
Trunk liners	Polyester blends
Trunk cover	PVC coated or polymer based nylon or PET
Clutch facings	Composites of carbon or aramid fibers
Tyre	PET, glass, aramid fibers, nylon, rayon fibers.

Table 1: Textile fibers used in various components in an automobile

### **3.1. Upholstery**

The volume of upholstery varies by region since manufacturers from different regions may prefer different styles of vehicle interiors. Both woven manufacture of automotive upholstery. An average of 5-6 m<sup>2</sup> of fabric is used in cars for upholstery. Modern designers are trying to give sporty or elegant look to the car interiors.

### **3.2. Carpets**

Carpet is an important part of the automotive interior. Carpets must withstand temperature extremes. Needle-felt carpets, tufted cut-pile carpets are generally used. Major car producers are using tufted cut-pile carpets in their cars. Carpets usually have a rubberized backing.

### **3.3. Pre-Assembled Interior Components**

Door kick panels, boot linings roof linings, parcel shelves and insulation (heat, sound, vibration etc.) materials are important examples for pre-assembled interior components. Coated laminated needle-punched non-woven and warp knits are the main materials used for the category.

### **3.4. Tyres**

The textile material in a type is used mainly for reinforcement. Textile materials such as viscose, glass and steel cords provide dimensional stability as well as reinforcement. Dimensional stability is an essential requirement for tyres. Strength is provided to tyres mainly by the web of fibres that lies with the body of the tyre called "Carcass".

### **3.5. Safety Device**

Due to governmental pressure and legislation, safety device have become a growing market for automotive textile. Seat belts and air begs are commonly used for safety in automobiles. The seat belts control the forward movement of the wearers in the controlled manner during sudden stoppage of the vehicle. About 1 Kg of textile fiber per car is consumed in seat belts. An airbags is an automatic safety restraint system that has gained significance within the last decade. Airbag is not an alternative to seat belt but a supplement. Seat belt provides a protection regardless direction of collision but air begs provide protection against head on collision

### **3.6. Filters And Engine Compartment Items**

Hoses, belts and linen are important components car engine which are reinforced with textile materials. Automotive filters are largely made of textiles. Some example of the filters used in automotive are largely made of textiles. Some examples of the filter are air filter and oil filter. The function of these filters is to filter the fluid before it enters the engine because of delicate machine component may be destroyed if the dust particle enters into the engine.



*Photo 2: Automotive Textiles Applications*

## 4. MANUFACTURING

### 4.1. Upholstery

One of the most traditional forms of automobile upholstery is plain woven cloth manufactured from air-jet textured and spun polyester. The textured yarns have good abrasion resistance because of their tight loop structure. The yarns contrived from 'core and effect' components can produce fabric cover of very good quality. These types of yarns are based on a central yarn called the 'core' which gives strength and stability to yarn.

Carmakers are increasingly favoring the usage of weft knitted fabrics for upholstery. These fabrics are generally manufactured on circular knitting machines and process sequence follows yarn dye route. Flat woven fabric is finished according to the yarn dye route. Finishing sequence for woven velvet upholstery is heat setting, brushing and then cropping. The ranges of finishing operations carried out are wide and varied but the objective is to produce fabrics with functional qualities and good aesthetic appeal. The formation of automotive upholstery involves the amalgamation of three layers i.e. face fabric, foam and backing material. The conventional method used for this purpose is 'Flame laminate on.' But this process is environmentally unfriendly and some times the laminates lack porosity which affect the sound absorption and comfort. Hence, new technologies such as hot melt adhesive application are being introduced. Hot melt adhesives are solvent-free adhesives, that are characteristically solid at temperatures below 180 degrees F (°F), are low viscosity fluids above 180°F, and rapidly set upon cooling. The development of hot melt adhesive technology stemmed from the previous use of molten wax for bonding. When this method no longer satisfied performance needs, 100 percent thermoplastic systems were introduced. Today, hot melt adhesives are used in a variety of manufacturing processes, including bookbinding, product assembly, and box and carton heat sealing.

There are a number of hot melt adhesives in use, with the most common being those used for hot melt pressure sensitive adhesive applications:

- ethylene vinyl acetate (EVA) copolymers, compatible with paraffin, the original hot melt;
- styrene-isoprene-styrene (SIS) copolymers;
- styrene-butadiene-styrene (SBS) copolymers;
- ethylene ethyl acrylate copolymers (EEA); and
- Polyurethane reactive (PUR).

Generally, these polymers do not exhibit the full range of performance characteristics required for an end product by themselves. Thus, "a variety of tackifying resins, waxes, antioxidants, plasticizers, and other materials are added to the adhesive formulation to enhance the polymer performance." The latest hot melt adhesive advance is the PUR adhesive, which is a 100 percent solid, one-component urethane prepolymer that "behaves like a standard hot melt until it reacts with moisture to crosslink or chain extend, forming a new polyurethane polymer." By curing the polymer in this way, PURs have performance characteristics that are more enhanced than those of standard hot melts. Unlike many of the other hot melts, which require a slot die or roll coater, PURs are applied to a substrate as a dot or a thin glue line, set in seconds, and are structurally rigid in minutes, following a final set. These adhesives have been accepted in many manufacturing industries, where they can be applied in small bond points to eliminate use of mechanical fasteners, such as staples, screws, rivets, clips, snaps, nails or stitching. Hot melt adhesives form a strong bond quickly simply by cooling, are compatible with most materials, and are clean and easy to handle. ) In general, hot melt adhesives are less water sensitive than other thermoplastic polymers, and are unaffected by water, moisture, or humidity, although if applied to a damp or wet surface the bonding may be poor. Hot melts can be formulated to increase their water sensitivity, as when used for stamps, envelopes and paper products that are to be recycled. Hot melt adhesives have some limitations that must be recognized. Hot melts cannot be used with heat sensitive substrates; the adhesive bonds lose strength at high temperatures; chemical resistance may be lacking with some types of hot melts; and exposure to high temperature environments can cause the adhesive to melt. Consequently, hot melt adhesives are inappropriate in situations where these limitations cannot be avoided. For example, hot melts should not be used on a substrate that would be near a heat source, such as a kitchen cabinet that would be placed near an oven. However, innovations in hot melts are removing some of these limitations: PURs are resistant to heat once they are cured, and could be used on substrates subsequently exposed to heat.

## 4.2. Carpets

Carpets are manufactured either by tufting or needle felting. Carpets made by tufting are based upon a supportive backing which is used as a base to accept the pile yarns which becomes the uppermost surface. Carpet backing is usually spun bonded and is made by an integrated process in which polymer chips are melted and filaments are extracted through a die. Mainly polyester is used in Making this carpet backing whereas a blend of nylon and polyester is used in some occasions. But during recent times polypropylene is assuming great importance considering the recyclability. The process of needling has got the advantages of more productivity at relatively low cost. But carpets produced by needling cannot be used to cover sharp counters especially foot areas and transmission tunnels. Superior needled material has a good filling which is determined by the amount of vertically oriented fibres at a given stitch density.



*Photo 3: Car carpets*

### 4.3. Seat Belts

Now a days wearing of seat belt is become compulsory for drives and front seat passengers. About 1 kg of textile fibre per car is consumed in seat belts. Seat Belts need to be as soft and flexible as possible along the length direction but as rigid as possible in the width direction so they can slide easily through buckles and to retract smoothly into housing. The edges must be scuff resistant but not unpleasantly hard and the material must be resistant to UV degradation and retain its strength for the life of the car- otherwise it must be replaced some of the first seat belts were made from polyester because of its superior resistance to UV degradation. Now days, the seat belts are being woven on shuttle less needle looms which can deliver up to 1000 picks per minute. Whereas, previously, the weaving used to be carried out on shuttle looms which were capable of delivering upto 200 weft insertions per minute from small weft suppliers, which frequently needed replenishing. Seat belt webbing is generally woven according to 2x2 twill design. The twill weave is preferred because warp threads lie parallel to the face and back of the webbing and as a result, the material has a high warp ways strength and low elongation.

### 4.4. Car Tyre

There are many textile components in a tyre such as casting belt breaker faric, bead wrapping fabric, chafer fabric, filler fabric, tyre cord fabric etc. nylon 6 and nylon 6,6 tyre yarns is used widely with nylon 6 being the major one. The fibres generally used for tyre cords are high tenacity filament yarns of nylon 6, nylon 6,6, polyester and viscose. In the past plied cotton yarn was used for the manufacture as tyre cord fabric as it had natural compatibility towards rubber fibres having high modulus such as Kevlar glass or steel are being used in manufacturer of cords compressing the breaker or belt layer viscose is the commonly used fibre in redial ply tyre casing. Carbon fires are also finding application in the form of reinforcing material.



*Photo 4: Car Tyre*

## 4.5. Air Bags

Stringent government legislation, consumer pressures are the driving forces for the massive growth and development of the air bags. In USA, the market for air bags is very huge and it is still in a growing stage in case of Japan and Western Europe. The requirement for an air bag material is high strength, resistance to ageing and abrasion, compatibility with coatings and good impact absorption. Hence nylon 6, is the mostly used material for the construction of air bags. Polyester is rarely used for this purpose and this trend seems to continue.

## 4.6. Seats

The seat is probably the most important item in the car interior. It is the first thing the customer sees when the car door is opened and he or she will probably instinctively touch it. Textiles have become by far the most widely used material in seat coverings and are beginning to be used in other areas of the seat in place of polyurethane foam. They are also used in a number of specialist cases in place of metal springs and actual seat pan and seat back. Now a day's polyester is very popular material for making seats, like polyester in the face fabric, Polyester non-woven in the cover laminate and polyester non-woven also in the seat squab and Cushion. The traditional method of seat making involves cutting and sewing of panels of the seat cover laminate (face fabric/foam/ scrim) into a cover, which is then pulled over the squab (seat back) and Cushion (seat bottom), and then fixed in place using a variety of clips and fastenings. This process is both time consuming and cumbersome. Hence several attempts have been made over the years to find better ways using a variety of techniques. Now a days three dimension seat covers are the very good. A seat cover comprises a knitting of a three-dimensional structure conforming in its external shape to that of a seat and including at least main portions, side portions and welt portions integrally knit into a one-piece form. The knitting further includes integrally knit portions covering overhang portions and corner portions of the seat and/or rear and bottom portions of a front back of the seat.

## 4.7. Head Liners

At one time the headliner was simply a covering for the metal roof inside the car and consisted of a piece of fabric, PVC or some other material sometimes simply 'slung'. i.e. held in place only at a few points. Some important requirements of headliners are light weight, thin profile but rigid without any tendency to buckle, flex or vibrate, good dimensional stability, aesthetically pleasing and preferably with a soft touch.

The modern headliner is a multiple laminate of up to seven or more components all joined together. Each layer is there for a specific purpose either for aesthetics, to provide sound insulation, vibration clamping or to provide rigidity to the whole structure. The central layer is generally a layer of semi-rigid thermomouldable polyurethane foam.

This layer is bounded to two layers of chopped fibre glass roving, one on each side. The layers of glass-roving help impart rigidity to the structure and noise reduction. Attached to the side facing inwards is the decorative material, a non-woven polyester scrim is usually attached to the other side. All layers are joined together by action of the hot-melt adhesives in a flat-bed laminator, taking care neither to damage the aesthetics of the decorative material nor to reduce the thickness of the centre core.



*Photo 5: Car Head Liners*

## 4.8. Textiles For Noise Control

Sound is propagated through the air and by vibration of the car body and there are three basic mechanism for reducing it, by absorption, by clamping and thirdly by isolation or insulation. In general thick piece of material will absorb more sound than a thinner piece of the same material. There are number of layers of material and permutations of layers of material used in noise and vibration damping.

These layers are,

1. Top decorative layer: - Tufted BCF Nylon or needle punched polyester or polypropylene- Back, acrylic ladere.
2. Thermoforming layer: - Polyethylene powder, moldable fibre EVA or a further thick layer of compounded SBR (styrene-butadiene rubbers) later.
3. Caustic layers: - “Heavy layers” of EPDM, Shoddy fibres or polyurethane foam.

These materials generally have to be fitted in small pieces, which is time consuming and produces an insulation performance which is interior to that of a continuous layer. In some vehicles this insulation layer is formed directly on the back of the pre-formed carpet it self by back injection moulding using polyurethane foam.

## 4.9. Cabin Air Filter

There are about a dozen different kinds of filter used in cars but only about half use textile materials. Paper is used in many applications such as the oil filter and carbure air filter, although non-wovens are used in some cars for the latter application. Dust diesel fumes and aromatic hydrocarbons can be even more damaging to health, hence filters are very much necessary. The latest advanced filters combine both mechanical filtering through polypropylene non-woven electret fabric with adsorption by activated carbon. Filter fabric is arranged in a pleated form to provide maximum surface area with minimum airflow resistance. The adsorption and retention capacity of the filter for odors in a given air flow rate is a measure of the filters performance. The non-woven filter fabric it self must be strong when wet is odor-free resistant to micro-organisms and resistant to extremes of temperature. Allied signal recently announced a filter for both particles and odors, which uses a system that is based on micro-fibres and a special liquid absorber.

## 5. CONCLUSION

Textile materials are used in automobiles for interior trim and for ensuring comfort (e.g. seat covers, carpets, roof liners, and door liners) as well as for reinforcement (e.g. tyre) and filters. Textiles also offer weight reduction which in turn results in fuel economy. Airbags help to save lives, but at times they can also be a source of serious injury. The search for a uniform smart airbag, which can perceive the size of the passenger or whether the seat is empty and react in that manner, is in progress. Such a 'smart' airbag will incorporate sensors to judge the weight, size and location of the car passengers and hence deploy more appropriately. In addition, incorporated safety devices associated with the seat belt along with other safety items, particularly for child passengers, are under development. The trend towards uncoated fabrics is anticipated to continue and so is the improved trend towards more airbags per car and full-size bags. There is also a technical challenge of producing the bag by using more rational techniques and related specifications made by the automotive industry.



## 6. LITERATURE

1. <https://www.sciencedirect.com/book/9781845693312/textile-advances-in-the-automotive-industry>
2. [https://www.researchgate.net/publication/326508226\\_Application\\_of\\_Textiles\\_In\\_Automobile\\_Application\\_of\\_Textiles\\_In\\_Automobile](https://www.researchgate.net/publication/326508226_Application_of_Textiles_In_Automobile_Application_of_Textiles_In_Automobile)
3. <https://www.technical-textiles.net/terms/automotive-textiles>
4. [http://www.ijirset.com/upload/2018/rdset/8\\_Paper\\_id-108.pdf](http://www.ijirset.com/upload/2018/rdset/8_Paper_id-108.pdf)
5. <https://www.grandviewresearch.com/industry-analysis/automotive-textiles-market>
6. <https://www.google.rs>
7. Schinder WD and Hauser PJ. Chemical finishing of textiles, Chapter 3, Cambridge, England: Woodhead Publishing Ltd., 2006.
8. Tarakcıođlu I. Tekstil terbiyesi ve makinaları. \_Izmir, Turkey: University of Ege, Textile and Ready Made Research and Application Center, 1996.
9. ASTM D 1776–08. Standard practice for conditioning and testing textiles 1 standard, 2009.

## LOUIS VUITTON - LORD OF BAGS

**Valentina Bozoki, Vasilije Petrovic, D. Joksimovic, A. Milosavljevic, S. Sindelic, \*J. Stepanovic**

Tehnički fakultet "Mihajlo Pupin", Zrenjanin,

\*Faculty of Technology Leskovac, University of Nis - The scholarship holder of the Ministry

Đure Đakovića bb, 23000 Zrenjanin

e-mail: [vanjica.bozoki@gmail.com](mailto:vanjica.bozoki@gmail.com)

### Abstract

*Louis Vuitton Malletier, commonly referred to as Loui Vuitton or shortened to LV, is a French fashion house and a luxury retail company founded in 1854 by Louis Vuitton. The label's LV monogram appears on most of its products, ranging from luxury trunks and leather goods to ready-to-wear, shoes, watches, jewelry, accessories, sunglasses and books. Louis Vuitton is one of the world's leading international fashion houses; it sells its products through standalone boutiques, lease departments and high-end department stores, and through the e-commerce section of its website. His quality is well known throughout the world. The fashion house Louis Vuitton merged with Moët Hennessy in 1987 and made a company known to everyone like LVMH. Details of the whole company, history and interesting facts will be described in this paper.*

**Key words:** LV, LVMH, bags, history, company

### 1. INTRODUCTION

*Since its creation, Louis Vuitton has been inspired by a desire to explore new horizons, continually accompanying a world in motion with its emblematic creations.*

Founded in Paris in 1854, Maison Louis Vuitton has inherited the ambition and vision of its founders. This legendary history built around travel continues to place the House at the forefront of creation. Still today, Louis Vuitton's spirit of adventure is expressed through its unique heritage, values and rigorous spirit of innovation and ingenuity, the boldness of its creations and the demand for perfection in its designs. Leather goods, ready-to-wear, accessories, shoes, watches and jewelry. The House's creations leave their mark with objects that have become legendary. All over the world, the House welcomes its clients into a world that reflects its founding values and that is sold exclusively in Louis Vuitton boutiques. Since November 2013, Nicolas Ghesquière has been the Creative Director of Women's Collections. Virgil Abloh has been the Creative Director of Men's Collections since March 26, 2018. When he was only sixteen years old, Louis Vuitton made a decision that would not only change his own life but the lives of his sons and future generations: he would become a trunk-master. Both a family residence and the cradle of the company, the Asnières site has been the symbol of the Vuitton family's personal and commercial success since 1859. The early success of Louis Vuitton meant he had to expand his operations. This led to the 1859 opening of his atelier in Asnières. Just northeast of the center of Paris, the workshop started with 20 employees. In 1900, there were nearly 100 people and by 1914 there were 225.

## 2. LOUIS VUITTON – BIOGRAPHY

Louis Vuitton was a French entrepreneur and designer whose name has become iconic in the fashion world.

Designer and entrepreneur Louis Vuitton was born on August 4, 1821, in Anchay, a small hamlet in eastern France's mountainous, heavily wooded Jura region. Descended from a long-established working-class family, Vuitton's ancestors were joiners, carpenters, farmers and milliners. His father, Xavier Vuitton, was a farmer, and his mother, Coronne Gaillard, was a milliner. Vuitton's mother passed away when he was only 10 years old, and his father soon remarried. As legend has it, Vuitton's new stepmother was as severe and wicked as any fairy-tale Cinderella villain. A stubborn and headstrong child, antagonized by his stepmother and bored by the provincial life in Anchay, Vuitton resolved to run away for the bustling capital of Paris. On the first day of tolerable weather in the spring of 1835, at the age of 13, Vuitton left home alone and on foot, bound for Paris. He traveled for more than two years, taking odd jobs to feed himself along the way and staying wherever he could find shelter, as he walked the 292-mile trek from his native Anchay to Paris. He arrived in 1837, at the age of 16, to a capital city in the thick of an industrial revolution that had produced a litany of contradictions: awe-inspiring grandeur and abject poverty, rapid growth and devastating epidemics.



*Photo 6. Louis Vuitton*

The teenage Vuitton was taken in as an apprentice in the workshop of a successful box-maker and packer named Monsieur Marechal. In 19th century Europe, box-making and packing was a highly respectable and urbane craft. A box-maker and packer custom-made all boxes to fit the goods they stored and personally loaded and unloaded the boxes. It took Vuitton only a few years to stake out a reputation amongst Paris's fashionable class as one of the city's premier practitioners of his new craft. When Napoleon assumed the title of Emperor of the French in 1852, his wife hired Louis Vuitton as her personal box-maker and packer. This provided a gateway for Vuitton to a class of elite and royal clientele who would seek his services for the duration of his life and far beyond, as the Louis Vuitton brand would grow into the world-renowned luxury leather and lifestyle brand it is today.

For Vuitton, 1854 was a year full of change and transformation. It was in that year that Vuitton met a 17-year-old beauty named Clemence-Emilie Parriaux. His great-grandson, Henry-Louis Vuitton, later recounted, "In the blink of an eye he exchanged the cloth frock and hobnailed shoes of a worker for the courting outfit of the day. The transformation was spectacular, but it required all the know-how of the store's department manager, since Louis' shoulders were much larger than those of Parisian bureaucrats."



*Photo 7. Louis, Georges and Gaston-Louis Vuitton (lying down on a trunk-bed) pose with factory workers in front of a horse-drawn delivery van. Asnières, 1888*

Vuitton and Parriaux married that spring, on April 22, 1854. A few months after his marriage, Vuitton left Monsieur Marechal's shop and opened his own box-making and packing workshop in Paris. The sign outside the shop read: "Securely packs the most fragile objects. Specializing in packing fashions."

In 1858, four years after opening his own shop, Vuitton debuted an entirely new trunk. Instead of leather, it was made of a gray canvas that was lighter, more durable and more impervious to water and odors. However, the key selling point was that unlike all previous trunks, which were dome-shaped, Vuitton's trunks were rectangular—making them stackable and far more convenient for shipping via new means of transport like the railroad and steamship. Most commentators consider Vuitton's trunk the birth of modern luggage. The trunks proved an immediate commercial success, and advances in transportation and the expansion of travel placed an increasing demand for Vuitton's trunks. In 1859, to fulfill the requests placed for his luggage, he expanded into a larger workshop in Asnières, a village outside Paris. Business was booming, and Vuitton received personal orders not only from French royalty but also from Isma'il Pasha, the Khedive of Egypt.

In 1870, however, Vuitton's business was interrupted by the outbreak of the Franco-Prussian War and the subsequent siege of Paris, which gave way to a bloody civil war that destroyed the French Empire. When the siege finally ended on January 28, 1871, Vuitton returned to Asnières to find the village in ruins, his staff dispersed, his equipment stolen and his shop destroyed. Showing the same stubborn, can-do spirit, he displayed by walking almost 300 miles alone at the age of 13, Vuitton immediately devoted himself to the restoration of his business. Within months he had built a new shop at a new address, 1 Rue Scribe. Along with the new address also came a new focus on luxury. Located in the heart of the new Paris, Rue Scribe was home to the prestigious Jockey Club and had a decidedly more aristocratic feel than Vuitton's previous location in Asnières. In 1872, Vuitton introduced a new trunk design featuring beige canvas and red stripes. The simple, yet luxurious, new design appealed to Paris's new elite and marked the beginning of the Louis Vuitton label's modern incarnation as a luxury brand.

### **3. ASNIÈRES : A LEGENDARY WORKSHOP THE HEART OF LOUIS VUITTON**

The exceptional savoir-faire of the Asnières artisans is such that even today, key pieces are created here: rigid trunks, designs in rare or exotic leathers, special orders. These one-off designs strive for perfection by bringing together technical innovation and quintessential style.

The Asnières atelier is the House's true hub and puts its soul into the creation of every special order.

The family's sons all learned the art of trunk-making here, including Patrick-Louis Vuitton, who is in charge of these special orders. To this day, each dream finds its special case as long as it can be transported. Shower-trunks, iPad trunks, or even one-off violin trunks... Travel remains at the heart of the House, where refinement is born of careful precision and attention to detail.

Construction of a tailor-made structure in poplar wood, the application of cement, canvas, lozine, metal corners and screws, malletage... Timeless gestures which express an inspirational magic. Artistic Director of Women's Collections Nicolas Ghesquière imagined the Petite Malle, a way of reinventing the trunk, the House's absolute symbol.



*Photo 8. Louis Vuitton bag*

### **GALERIE IN MOMENT**

From within its "Galerie" in Asnières, Louis Vuitton presents the newly installed Time Capsule, a journey through the history of the House that revisits its landmark innovations in technology and design. Travelling from the House's beginnings in 1854 to the present day, the story is told using rare and celebrated objects selected from the Louis Vuitton archive.

The exhibition follows a visual timeline of landmark moments in the Louis Vuitton story, demonstrating the ways in which Louis Vuitton has anticipated the needs and desires of a changing world over 160 years generated by technological progress, with imaginative and ingenious new creations.

In Time Capsule, heirloom designs live alongside some of the House's most contemporary pieces, highlighting the ongoing commitment to constant innovation.



*Photo 9. Time Capsule 1*

World over 160 years generated by technological progress, with imaginative and ingenious new creations.

In Time Capsule, heirloom designs live alongside some of the House's most contemporary pieces, highlighting the ongoing commitment to constant innovation.



*Photo 11. Time Capsule 3*



*Photo 10. Time Capsule 2*



*Photo 12. Time Capsule 4*

#### 4. HISTORY OF FASHION HOUSE LV

The Louis Vuitton label was founded by Vuitton in 1854 on Rue Neuve des Capucines in Paris, France. Louis Vuitton had observed that the HJ Cave Osilite trunk could be easily stacked. In 1858, Vuitton introduced his flat-topped trunks with trianon canvas, making them lightweight and airtight. Before the introduction of Vuitton's trunks, rounded-top trunks were used, generally to promote water runoff, and thus could not be stacked. It was Vuitton's gray Trianon canvas flat trunk that allowed the ability to stack with ease for voyages. Many other luggage makers imitated LV's style and design.

The company participated in the 1867 Universal Exhibition in Paris. In 1871, Ōyama Iwao became the first recorded Japanese customer, ordering a set of luggage while in Paris as a military observer during the Franco-Prussian War. To protect against the duplication of his look, Vuitton changed the Trianon design to a beige and brown stripes design in 1876. By 1885, the company opened its first store in London on Oxford Street. Soon thereafter, due to the continuing imitation of his look, in 1888, Vuitton created the Damier Canvas pattern, which bore a logo that reads "marque L. Vuitton déposée", which translates into "L. Vuitton registered trademark". In 1892, Louis Vuitton died, and the company's management passed to his son.



*Photo 13. Louis Vuitton's logo*

After the death of his father, Georges Vuitton began a campaign to build the company into a worldwide corporation, exhibiting the company's products at the Chicago World's Fair in 1893. In 1896, the company launched the signature Monogram Canvas and made the worldwide patents on it. Its graphic symbols, including quatrefoils and flowers (as well as the LV monogram), were based on the trend of using Japanese Mon designs in the late Victorian era. The patents later proved to be successful in stopping counterfeiting. In this same year, Georges traveled to the United States, where he toured cities such as New York, Philadelphia, and Chicago, selling Vuitton products. In 1901, the Louis Vuitton Company introduced the Steamer Bag, a smaller piece of luggage designed to be kept inside Vuitton luggage trunks. By 1913, the Louis Vuitton Building opened on the Champs-Élysées.

It was the largest travel-goods store in the world at the time. Stores also opened in New York, Bombay, Washington, London, Alexandria, and Buenos Aires as World War I began. Afterwards, in 1930, the Keepall bag was introduced. During 1932, LV introduced the Noé bag. This bag was originally made for champagne vintners to transport bottles. Soon thereafter, the Louis Vuitton Speedy bag was introduced (both are still manufactured today). In 1936 Georges Vuitton died, and his son, Gaston-Louis Vuitton, assumed control of the company.



*Photo 14. In 1886, Georges Vuitton revolutionized luggage locks with an ingenious closing system that turned travel trunks into real treasure chests.*

## **1. LVMH Moët Hennessy – Louis Vuitton SE**

LVMH Moët Hennessy – Louis Vuitton SE, also known as LVMH, is a French multinational luxury goods conglomerate headquartered in Paris. The company was formed in 1987 under the merger of fashion house Louis Vuitton with Moët Hennessy, a company formed after the 1971 merger between the champagne producer Moët & Chandon and Hennessy, the cognac manufacturer.



*Photo 15. LVMH*

It controls around 60 subsidiaries that each manage a small number of prestigious brands. The subsidiaries are often managed independently. The oldest of the LVMH brands is wine producer Château d'Yquem, which dates its origins back to 1593.

Christian Dior SE is the main holding company of LVMH, owning 40.9% of its shares, and 59.01% of its voting rights. Bernard Arnault, majority shareholder of Dior, is Chairman and CEO of both companies. In 2017, Arnault purchased all the remaining Christian Dior shares in a reported \$13.1 billion buy out. The Dapifer reports that LVMH will gain ownership of Christian Dior haute couture, leather, both men's and women's ready-to-wear, and footwear lines.

Arnault's successful integration of various famous aspirational brands into a single group has inspired other luxury companies to do the same. Thus, the French conglomerate Kering (formerly named PPR) and the Swiss-based Richemont have also created extended portfolios of luxury brands. The company is a component of the Euro Stoxx 50 stock market index.



LVMH is headquartered in the 8th arrondissement of Paris, France. The company is listed on the Euronext Paris exchange, and is a constituent of the CAC 40 index. As of 2010, the group had revenues of €20.3 billion with a net income of just over €3 billion. By 29 February 2016, the company had a share value of 78,126 million euros, distributed in 506,980,299 shares. In 2013, with revenue of \$21,7 billion, LVMH was ranked first luxury goods company in Deloitte's "Global Powers of Luxury Goods" report. The group currently employs more than 83,000 people. Thirty percent of LVMH's staff work in France. LVMH operates over 2,400 stores worldwide. Its current business plan aims to tightly control the brands it manages in order to maintain and heighten the perception of luxury relating to their products. For example, Louis Vuitton products are sold only through Louis Vuitton boutiques found in upmarket locations in wealthy cities or in concessions in other luxury goods shops (such as Harrods in London).

### **HOUSES THAT COMBINE CREATIVITY WITH TIMELESSNESS**

Preserving an identity and roots, while at the same time constantly reinventing themselves in order to appeal to their contemporaries, has always been the “raison d’être” of the Houses in LVMH’s Fashion & Leather Goods sector. Over the years, this division has been enriched with young Houses that also allow creative talents rich with promise to express themselves.

In order to guarantee a fitting environment for their exceptional products, the Houses in the Fashion & Leather Goods sector strive to master their distribution: in this way, they offer their clientèle unique purchasing experiences.



*Photo 16. Info about LVMH*

### **6. BERNARD ARNAULT**

Bernard Jean Étienne Arnault, (born 5 March 1949) is a French business magnate, investor, and art collector. Arnault is the Chairman and Chief Executive of LVMH Moët Hennessy – Louis Vuitton SE, commonly referred to as LVMH, the world's largest luxury-goods company. He is the richest person in Europe and the fourth-richest person in the world according to Forbes magazine, with a net worth of \$94.6 billion, as of April 2019. In April 2018, he became the richest person in fashion, toppling Zara's Amancio Ortega.

In 1987, shortly after the creation of LVMH, the brand new luxury group resulting from the merger between two companies, Arnault mediated a conflict between Alain Chevalier, Moët Hennessy's CEO, and Henri Racamier, president of Louis Vuitton. The new group held property rights to Dior perfumes that Arnault believed should be incorporated into Dior Couture.

In July 1988, Arnault provided \$1.5 billion to form a holding company with Guinness that held 24% of LVMH's shares. In response to rumors that the Louis Vuitton group was buying LVMH's stock to form a "blocking minority", Arnault spent \$600 million to buy 13.5% more of LVMH, making him LVMH's largest shareholder. In January 1989, he spent another \$500 million to gain control of a total of 43.5% of LVMH's shares and 35% of its voting rights, thus reaching the "blocking minority" that he needed to stop the dismantlement of the LVMH group. On 13 January 1989, he was unanimously elected chairman of the executive management board.



*Photo 17. Bernard Jean Étienne*

In July 1988, Arnault provided \$1.5 billion to form a holding company with Guinness that held 24% of LVMH's shares. In response to rumors that the Louis Vuitton group was buying LVMH's stock to form a "blocking minority", Arnault spent \$600 million to buy 13.5% more of LVMH, making him LVMH's largest shareholder. In January 1989, he spent another \$500 million to gain control of a total of 43.5% of LVMH's shares and 35% of its voting rights, thus reaching the "blocking minority" that he needed to stop the dismantlement of the LVMH group. On 13 January 1989, he was unanimously elected chairman of the executive management board.

Since then, Arnault led the company through an ambitious development plan, transforming it into one of the largest luxury groups in the world, alongside Swiss luxury giant Richemont and French-based Kering. In eleven years, the market value of LVMH has multiplied by at least fifteen, while, simultaneously, the sales and profit rose by 500%. He promoted decisions towards decentralizing the group's brands. As a result of these measures, the brands are now viewed as independent firms with their own history.

## 7. CONCLUSION



*Photo 18. Virgil Abloh*

The design of the brand LVMH, which we know today, is the work of Mark Jacobs, who redesigned the famous logo, refreshed the brand and with excellent marketing, brought the company to millions.

The current chief editor of the male collection is *Virgil Abloh* since March 2018, marking him the first person of African descent to lead the brand's menswear line, as well as one of the few black designers at the helm of a major French fashion house. Upon his acceptance of the position, he stated, "It is an honor for me to accept this position. I find the heritage and creative integrity of the house are key inspirations and will look to reference them both while drawing parallels to modern times". Abloh showed his first collection for Louis Vuitton at the 2018 Men's Fashion Week at the Palais-Royal gardens in Paris.

Louis Viton, as you see, supports everyone who is different and who have an idea. He constantly receives workers and trains people for different sectors and areas. They are always open to cooperation if you notice the potential. Because of its specificity in every respect LV has always been and will always be must have every girl. There is magic in this countless times a copied monogram, it is distinguished by some elegance and, above all, obvious quality. But the biggest shock to me was when I read that the bags were destroyed at the end of the season if they were not sold or if they were repelled by the red cross and company employees, knowing how many girls are dying for the same bag!



*Photo 19. New collection*



*Photo 15. New collection*



*Photo 16. New collection*

## 8. LITERATURE

1. Mavinkurve AA, Ji L and Maria Krings LH. Compound and method of improving wrinkle resistance in fabrics, and device for containing such a compound. Patent Application 0083025 A1, USA, 2007.
2. <https://eu.louisvuitton.com/eng-e1/la-maison/a-legendary-history#tumbler>
3. <https://en.wikipedia.org/wiki/LVMH>
4. <https://www.lvmh.com/houses/fashion-leather-goods/>
5. <https://www.lvmh.com/houses/fashion-leather-goods/louis-vuitton/>
6. [https://en.wikipedia.org/wiki/Louis\\_Vuitton](https://en.wikipedia.org/wiki/Louis_Vuitton)
7. [https://en.wikipedia.org/wiki/Bernard\\_Arnault](https://en.wikipedia.org/wiki/Bernard_Arnault)
8. <https://www.biography.com/fashion-designer/louis-vuitton>
9. <https://eu.louisvuitton.com/eng-e1/la-maison/asnieres#la-galerie>
10. [https://en.wikipedia.org/wiki/Virgil\\_Abloh](https://en.wikipedia.org/wiki/Virgil_Abloh)
11. <https://wannabemagazine.com/prica-o-louis-vuitton-u/>

## **EMBROIDERY ON BANAT NATIONAL COSTUMES**

**Mina Milaković, V. Petrovic, D. Joksimovic, A. Milosavljevic, M. Pesic**

University in Novi Sad

Technical Faculty "Mihajlo Pupin" Zrenjanin

e-mail: [minamilakovic0@gmail.com](mailto:minamilakovic0@gmail.com)

### **ABSTRAKT**

*Banat, Vojvodina, embroidery, art, costume, fabrics, embroidery, letter embroidery, white embroidery, golden embroidery.*

*The aim of the work is to provide information of the cultural tradition, authenticity and authenticity of connections, and pointing to new possibilities of applying connections in modern solutions.*

### **1. INTRODUCTION**

The connection that we recognize today, has its roots in the 18th century. The embroidery is in Banat area, one of the most common ways of decorating fabrics in all ethnic groups. White embroidery, color and golden embroidery embellished textile parts of folk costumes and ceremonial folk costume. The national embroidery embroidery was not only decorative, but its role was multilayered. The type and richness of connections on a national dress indicates a social status, age or material wealth. The embroidery also defines the purpose of the subject itself, and also determines its use in everyday life. In the further work I dealt with the techniques of making connections.

### **2. NATIONAL COSTUME**

National costumes in Banat had the characteristics of Pannonian, Central European and Balkan culture. Summer costumes were made of cotton or cloth, and winter made of cloth, sheepskin or woolen weaving. The way of making, decorating, and the types of materials from which they were made, emphasized not only ethnicity, but also the age within the same ethnic group. After the costume, for example, girls were distinguished from married women, middle-aged women and old women. The quality of the materials from which it was made and the manner of decoration pointed out also to the material condition of the person wearing the costume and all of her families. The basis of Banat costumes consists of a shirt or caksire, and its cut, material and technique of making old ones are Slovenian origin. Already the material (flax, hemp) and the method of production indicates that these clothes became the costume of the fodder. This is the basis of Banat costumes, and in this pure form, it is of Pannonian-Scythe type, while the golden embroidery that appears on the hairstyles and the woman's costume is indicative of its ornate influence.



*Picture 1: Romanian national costume, Sutjeska, beginning of 20th century*

### **3. EMBROIDERY**

In the traditional village community, the embroidery belonged to the domain of the domestic work of women. The folk embroidery was mainly dealt with by the girls to whom he was often the only possibility to express his artistic talent. The folk embroidery was performed mostly on a domestic fabric of cotton, cedar or linen. Of this type of woven linen, textile parts of furniture (tablecloths, towels, overcoats ...), as well as parts of national costumes (pants, shirts ...) were made. In addition, the embroidery is made on leather, cloth, but also on purchase materials such as plush, brocade and silk. Embroidery was made at first by the nits, which were also domestic manufactured from the same raw materials. They are painted as well as the basis of natural, herbal colors. Later, at the end of the 19th century, the purchase thread included a link that quickly pushed the end of domestic production. At the end of the 19th and the beginning of the 20th century, the so-called gold and silver thread are made the most representative parts of folk costumes. The needle is the main technical aid in connection. With it, the decorative thread stretched across the floor. Embroidery represents the final phase in the production of one textile product and the most important aspect of artistic expression on the fabric. During his creation, he needs knowledge of drawing and painting, a developed sense of color, knowledge of color composition and various embroidery techniques.

#### **3.1. TECHNIQUES OF CONSTRUCTION**

When it comes to making embroidery, there are two basic divisions. The first division is related to the way the embroidery is applied to the surface, and according to it, we distinguish the embroidery by letter and the number. Another division is done according to the color of the end, namely nor for a bond. This group includes white embroidery and gold embroidery.

##### **3.1.1. NUMBER EMBROIDERY**

Number embroidery is one of the ways of making connections that involves counting the threads or basics on the fabric that is connected. In Banat, the number embroidery was most often applied in a white connection in the form of up-to-date techniques. By number embroidery, the colored technique and the goblen - curve point were made. The ornament made in this manner has a distinctive stylization regardless of whether it is a geometric or floral motif.



*Picture 2. Pokrstica*

### **3.1.2. THE LETTER EMBROIDERY**

The embroidery-by-letter is an embellishment which is performed on a patterned pattern. The embroidery with the needle and the end is accompanied by a pre-drawn line of motifs. He is present on various textile objects: from clothing to decorative - interior to religious, and even items that were in some form of official use. Typical representatives of bonds by letter are a white tie, a colored tie and a golden embroidery.

### **3.1.3. WHITE EMBROIDERY**

White embroidery represents the most typical connection in the area of Vojvodina and it is represented equally among all ethnic groups. At first, it was used by Protestants for decoration of priestly and sacred textile items. The main reason for its high presence is in the fact that its production is relatively cheap, and it is extremely effective. It is exclusively white cotton or silk finish on white cotton, linen or straw mat. It is usually done as a binding letter, by motive motives, but it also happens as a embroidery by number.



*Picture 3: Manual white embroidery*

### **3.1.3. EMBROIDERY IN COLOR**

The color embroidery, as we today know and connect with traditional folk art, is a relatively new phenomenon. Its development was directly influenced by industrialization and the appearance of factory colors, as well as the appearance of cotton and silk thread. The color embroidery was also performed by letter and numbering of the base. A wide range of colors of the factory cotton end made it possible for a large number of shades and motifs. Ornament is most often floral presented in the form of bouquets, wreaths, various fruits and bunches.



*Picture 4: Color embroidery*

### 3.1.5. GOLDEN EMBROIDERY

The embroidery with golden wire is one of the ways to decorate the festive parts of Banat national costumes. Golden embroidery had all the features of European styles - late Baroque and rococo. Golden embro was made on domestic cotton cloth, silk, brocade or plush. As additional decorative details under the influence of Biedermeier, goldsmiths apply appliques, beads and multicolored glasses. Ornamentation made of goldsmiths (flower branches, bouquets ...) represents typical ruralized forms of Central European baroque. In the middle Banat, golden embroidery are decorated with the most sophisticated parts of national costumes, among which the a bridal suit are distinguished by their beauty and the richness of ornaments, then they are jeleci, oplecci and aprons, men's shirts, formeti, bekesi and belts.



*Picture 5: Golden embroidery with tinsel*

## 4. MODERN COLLECTION INPIRED BY THE BANATIC NATIONAL EMBROIDERY



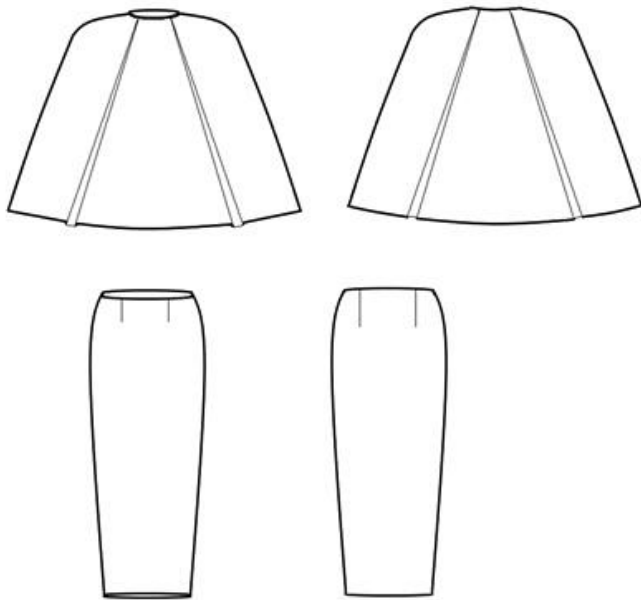

*Sketch 1*

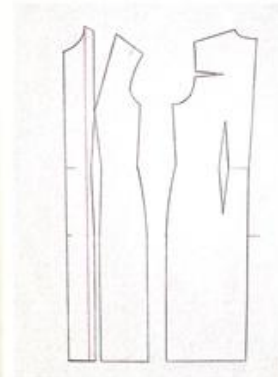
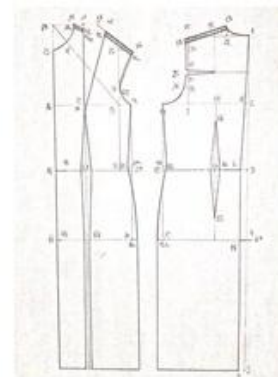
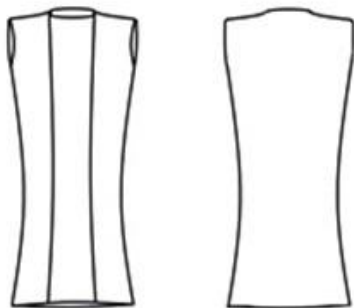

*Basic construction and modeling of the dress on the given sketch*



## 5. CONCLUSION

The Banat embroidery was one of the most common ways of decorating fabrics in the area of Vojvodina, with techniques of embroidery by letter and embroidery by number, which were performed in white connection, color and golden ties. I decided for a Banat embroidery because it is a beautiful and good connection with modern clothes. As you can see on the sketches of the fashion collection, I mostly dealt with the color connection and, most importantly, gold jewelry. I worked on the design and modeling of the dress, because it is very elegant and simple, and it is also worth golden embroidery.

## 7. LITERATURE

- [1] <http://www.zrenjanin.rs/1-144-127-0/Odevanje>
- [2] Grubić Rajka, Zlatovez u zbirci Narodnog muzeja u Zrenjaninu, Glasnik muzeja Banata, Pančevo, 1998.
- [3] Maluckov Mirjana, Narodna Nošnja, Narodna umetnost Vojvodine, Novi Sad, 1980.
- [4] Novaković Katarina, Odlike narodnog veza u Vojvodini, Rad muzeja Vojvodine 46, Novi Sad, 2004
- [5] Reljić Ljubomir, Tkanine, vez i čipke iz Vojlovice, Pančevo, 1977.
- [6] <http://www.riznicasrpska.net/likovnaumetnost/index.php?topic=45.0>
- [7] <https://ilovezrenjanin.com/vesti-zrenjanin/prozimanje-kultura-narodno-stvaralastvo-banata/>
- [8] <https://ilovezrenjanin.com/kultura/izlozba-narodni-vez-tradicija-kao-inspiracija/>
- [9] Autori: Darko Ujević, Dubravko Rogale, Marijan Hrastinski, "Tehnike konstruiranja i modeliranja odeće", treće dopunjeno i prošireno izdanje, sveučilišni udžbenik tekstilno-tehnološkog fakulteta u Zagrebu, Zrinski Čakovec, 2010.

## NATIONAL COSTUME OF THE MACVA AS AN INSPIRATION FOR CONTEMPORARY FASHION

Ivana Krulj, V. Petrovic, D. Joksimovic, A. Milosavljevic, M. Pesic, S. Sindjelic  
Technical Faculty „Mihajlo Pupin” Zrenjanin  
Đure Đakovića bb, 23000 Zrenjanin  
e-mail: [ivana.krulj55@gmail.com](mailto:ivana.krulj55@gmail.com)

### *Abstract*

*The work presents national costume from the County of Macva as an inspiration for contemporary fashion. There are information of life in Macva and their population, contemporary costumes inspired by this period and their technological sketch. The aim of the work is to show how many ethno motives actually refresh today's fashion, highlight it by their strangeness and promote cultural heritage.*

*Key words: Macva, national costume, tradition, contemporary fashion*

### **1. Introduction**

National costume is usually a name for traditional historical clothes. Costumes are different by region, country, and ethnic group. Apart from the before mentioned items, costumes also differed by their social status, emotional status and the occasion in which they were worn. They occupy a prominent place in culture and tradition and are very striking for their aesthetic and artistic values. Parts of Serbian folk costumes are very striking and make it: Sajkaca, Vest, Gunj, Gunjic, Ferme, Anterija, Zubun, Dolaktenik, Tkanica, Briget pants, Caksire, Dizluk, Dolama, Jecerma, Dzamadan, Misaraba, Mintane, Jelek, Dzube, Libade, Fistan, Salvare, Kumos, Woolen or knit socks, Opanci (spiked).

### **2. Macva**

Macva is a plain area located in the northwestern part of Serbia, between the Drina and Sava rivers. It is about 80 kilometers from Belgrade, west. The largest part of the Macva is occupied by the town of Sabac. Its landscapes are covered with fertile alluvial soil very suitable for field and vegetable growing. The region was named after the city of Macva, which existed in the Middle Ages on the banks of the Sava River. In the past, it was known as Donji Srem while the neighboring region located on the northern coast of the Sava River was known as Gornji Srem.

Ethnographic collection of the National Museum in Sabac has close to 1 500 objects related to the material and spiritual culture of Macva, Posavina and Pocerina. The largest number of objects is stored in the depot, while one part is exposed in the permanent exhibition of the museum. Part of the museum item was redeemed and the rest was given as a gift.

In ancient times there has been national art in Macva, in which the unified heritage and aspiration to preserve identity exist. The ethnographic culture of this nation is very rich, diverse and creatively-aesthetically worthy. Historical heritage, economic and social factors conditioned the creation of a transitional zone of national culture and artistic creativity. They used different materials in shape and decoration to express aesthetic feelings. The folk art of the Macva includes weaving, embroidery, knitting, woodworking, forging, casting...



*Picture 1. The area of Macva*

### 3. National costume od Macva

Because of the importance of folk costumes in this area, the sense of decorating clothes, especially women's folk costumes, with stylization of plant and geometric motifs, in textile bonding and textile applications, was very pronounced. Regardless of certain influences and changes, the costume is passed on to the generations. In the Macva area, we developed all the weaving techniques that include square weaving, kneeling, knitting, embroidery and knitting. On the sleeves, aprons, teeth, carpets dominates ornaments and geometric shapes - rhombuses, squares, crosses, stylized flowers and twigs. In addition to the simple rhombuses, the meander is one of the most useful motifs in making costumes. The creation of lace and embroidery here has reached high artistic reach, and the techniques have been brought to perfection. Jeleci, kozusi and gunjevi are also worthy of attention because of rich ornaments with colorful skin and lung applications. In addition, its aesthetic value was mirrored in the shirts. With folk costumes, he used to wear a diverse and rich jewelry as a sign of wealth, honor, and social status.



*Picture 2. Men's and women's national costume*



*Picture 3. Men's and women's national costume*

**a. Women's national costume**

Women's folk costume in this region is very diverse. It consists of a wide embroidered shirt with assorted sleeves, skute, front and back aprons, jeleka and libada decorated with embroidery, socks long to knees embroidered with wool and geometric fiugrams and belts. Women combed their hair in a characteristic manner-into braids, which underneath the back of their neck they twisted and wrap around their heads.



*Picture 4. Women's national costume*



*Picture 5. Libada*



*Picture 6. Jelek from women's national costume*

The aprons are vividly embroidered, richly decorated with golden embroidery with floral motifs dominated by roses, flowers, lalas and carnation. The ornamentation on the cheeks is revived by the harmony of colors and indicates a lush folk art.



*Picture 7. Details from apron*

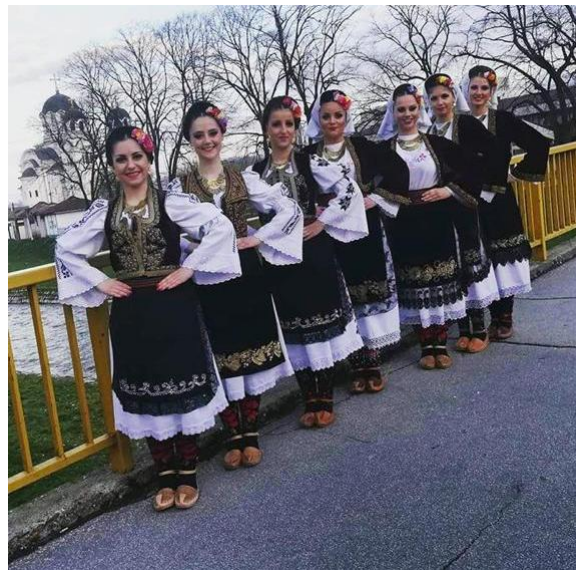

*Picture 8. Women's summer and winter national costume*

### **b. Men's national costume**

Men's costume consists of a long shirt, wide pants through which can be narrow or wider caksire, a vest, a wool belt around the waist, short woolen socks, homemade opanci with a beak in the middle and a subara. Later, due to the proximity of Srem and the narrow trade relations at the end of the 19th century, the costumes of Vojvodina costume were worn in the costumes of this region.



*Picture 9. Men's national costume*



ritnicaspiska.net

*Picture 10. Jelek from men's national costume*



LIRAFOLKLOR

*Picture 11. Men's and women's national costume*

#### **4. National costumes as an inspiration for modern clothing**

The purpose of today's fashion is to look original and different. Ethno motif refreshes today's fashion and stands out with its strangeness, as the former styles are returning and reborn in new clothes, and ethno culture is revived in re-use on the world fashion catwalks. Due to the monitoring of some stylish fashion trends, the ethno motive is not sufficiently exploited. Due to their specificity, these motifs easily fit into modern pieces of dressing and refreshed their appearance. The production of these loose objects would differ, as this would involve the use of techniques such as embroidery and knitting.



*Picture 12. National costumes as an inspiration for modern clothing*



### 5. Technological sketches of contemporary garments from the collection

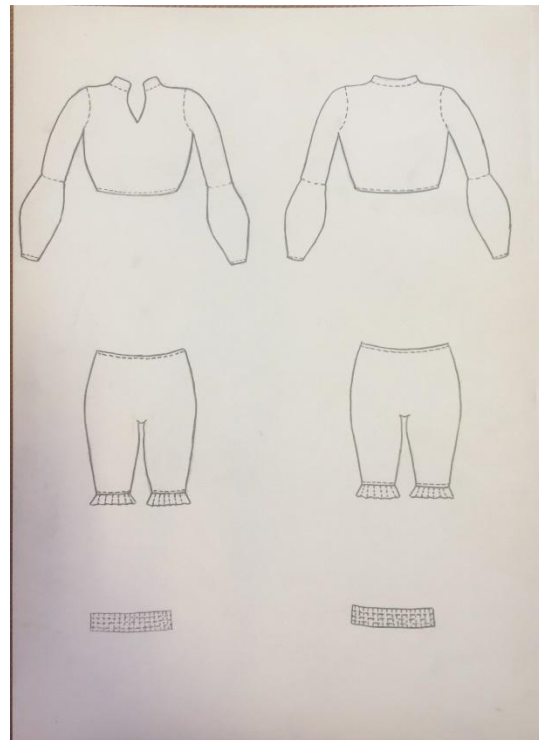
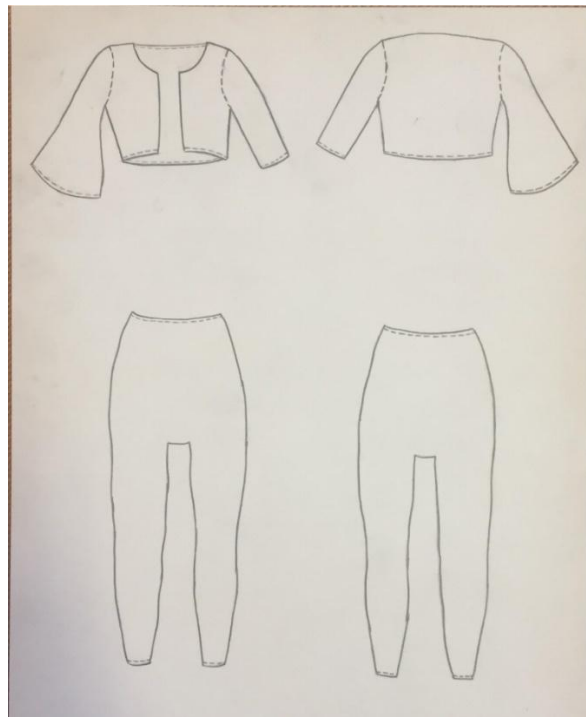
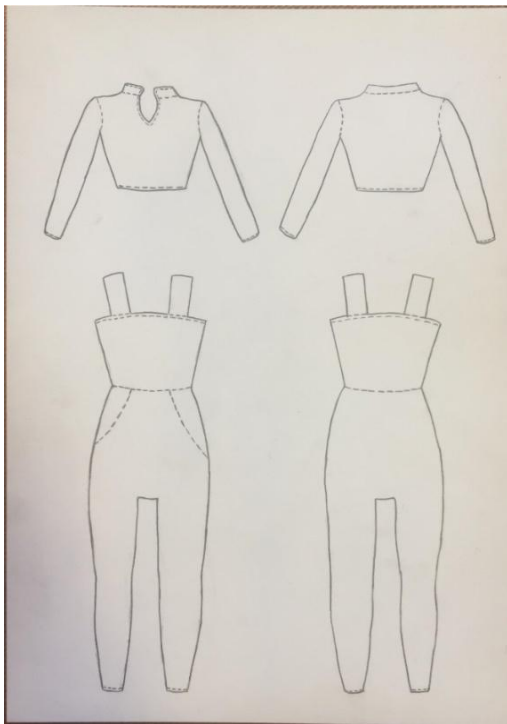



## 6. Conclusion

National costume is a reflection of the culture, life and existence of a nation. It contributes to the recognition of specific areas and their lifestyles. When creating them, they need to know the techniques that exist for centuries. Such a gift of culture can easily serve as an inspiration for modern clothing. Ethno motifs improve, do not attach to trends, and always look unusual and unique, just as modern dressing and should look.

## 7. Literature

[1] The National Museum Sabac

[2] J.Stepanović, S. Janjić: Mehaničke tekstilne tehnologije, Univerzitet u Banjoj Luci, 2015.

[3] Tehničke informacije proizvođača Mesdan, 2016.D. Radivojević, M. Đorđević, D. Trajković: Ispitivanje tekstila, Visoka strukovna škola za tekstil, Leskovac, 2016.

[4] UA „Civija”

[5] <https://sr.wikipedia.org>

[6] <http://www.riznicasrpska.net/>

[7] <https://wannabemagazine.com/>

## APPLICATION OF TEXTILE FOR DIVING SUITS

Valentina Bozoki, Vasilije Petrovic, J. Danka, M. Anita, S. Stanislava  
Tehnički Fakultet "Mihajlo Pupin", Zrenjanin,  
Đure Đakovića Bb, 23000 Zrenjanin  
e-mail: [vanjica.bozoki@gmail.com](mailto:vanjica.bozoki@gmail.com)

### Abstract

*A diving suit is a garment or device designed to protect a diver from the underwater environment. Diving suits can be divided into two classes: "soft" or ambient pressure diving suits – examples are wetsuits, dry suits, semi-dry suits and dive skins –, and "hard" or atmospheric pressure diving suits, armored suits that keep the diver at atmospheric pressure at any depth within the operating range of the suit. And diving suits are exactly what I will exhibit in my work. What material is being made, about the history of the diving suit and some interesting things.*

**Key words:** diving suits, material, history

## 1. INTRODUCTION

### 1.1. ABOUT DIVING

*Diving* is today one of the fastest growing sports in the world, and there has always been a man's desire to sink below the surface of the sea, the lake, for the purpose of salvation, hunting, recreation or for military purposes. Recreational diving is an extreme sport that allows underwater activities with the help of specialized equipment at depths of up to 40 meters. Recreational diving requires quality training, regular and proper maintenance of equipment, strict safety rules and strict adherence to established procedures and procedures. Modern recreational diving equipment consists of diving suit, mascot, feather, buoyancy compensator, weights, compressed air bottles and two-stage pressure regulator. In addition to these parts of the equipment, the diver can also have many others, such as a computer, gloves, hood, knife, lamp, compass, spool and camera, but they are not necessary in all conditions. Diving equipment must be properly maintained and regularly serviced in accordance with the manufacturer's instructions. *Diving suit* protects diver from loss of temperature and injury. By construction it can be *wet* or *dry*.

A *wetsuit* is a garment, usually made of foamed neoprene, which is worn by surfers, divers, windsurfers, canoeists, and others engaged in water sports and other activities in or on water, primarily providing thermal insulation, but also buoyancy and protection from abrasion, ultraviolet exposure and stings from marine organisms. A *dry suit* or drysuit provides the wearer with environmental protection by way of thermal insulation and exclusion of water, and is worn by divers, boaters, water sports enthusiasts, and others who work or play in or near cold or contaminated water. A dry suit normally protects the whole body except the head, hands, and possibly the feet. In hazmat configurations all of these are covered as well.

## 2. HISTORY OF DIVING SUITS

The first diving suit designs appeared in the early 18th century. Two English inventors developed the first pressure-proof diving suits in the 1710s. John Lethbridge built a completely enclosed suit to aid in salvage work.

It consisted of a pressure-proof air-filled barrel with a glass viewing hole and two watertight enclosed sleeves. This suit gave the diver more maneuverability to accomplish useful underwater salvage work. After testing this machine in his garden pond (specially built for the purpose) Lethbridge dived on a number of wrecks: four English men-of-war, one East Indiaman (both English and Dutch), two Spanish galleons and a number of galleys. He became very wealthy as a result of his salvages.

At the same time, Andrew Becker created a leather-covered diving suit with a helmet featuring a window. Becker used a system of tubes for inhaling and exhaling, and demonstrated his suit in the River Thames, London, during which he remained submerged for an hour.

German-born British engineer Augustus Siebe developed the standard diving dress in the 1830s. Expanding on improvements already made by another engineer, George Edwards, Siebe produced his own design: a helmet fitted to a full length watertight canvas diving suit. Later suits were made from waterproofed canvas invented by Charles Mackintosh. From the late 1800s and throughout most of the 20th century, most standard dress was made from a sheet of solid rubber laminated between layers of tan twill.



*Photo 20. Early diving suit on display at the Naval History Museum in Mexico City.*



*Photo 2. sketching antique diving suit (technical)*



*Photo 3. Richard Fleischer, in a diving suit while shooting "20 000 Miles Under the Sea"*

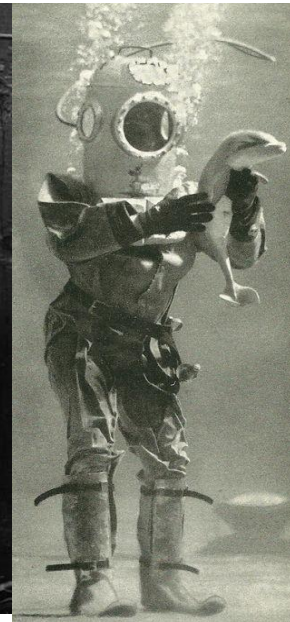

*Photo 4. Diving suit underwater*

### 3.PURPOSE OF DIVING SUITS

Diving suits are for protecting and protecting the carriers from exposed cold. They also provided protection against abrasive and sharp objects that are difficult for harmful underwater life.

Protects divers from water pressure and various bacteria that are located at greater depths. There are various types of diving suits, but they can mostly be reduced to dry and wet diving suits.

Also, they do not use solely divers, use other people for other physical activities in the form of sports, using them as thermal protection (surfing, sailing, windsurfing, water skiing, swimming, etc.).

Diving suit protects diver from loss of temperature and injury. By construction it can be wet or dry.

Wet suits are made of neoprene of different thicknesses, depending on the water temperature for which they are intended. They are used for temperatures above about 4°C. Maintain body temperature by means of a thin layer of water created between the suit and the body of the diver. Modern wet diving suit was developed in 1952 by Hugh Bradner of the University of California Berkeley

Dry suits are watertight and are used in cooler waters, mostly for temperatures below 15°C or for longer dives at higher temperatures. They consist mainly of two layers: a membrane that prevents water penetration and thermal insulation. Like wet suits, dry suits provide passive thermal protection and protection against injury. A dry suit can have integrated boots and usually comes complete with gloves.

Wetsuits are used for thermal insulation for activities where the user is likely to be immersed in water, or frequently doused with heavy spray, often approaching from near-horizontal directions, where normal wet-weather clothing is unlikely to keep the water out. Activities include underwater diving, sailing, sea rescue operations, surfing, river rafting, whitewater kayaking and in some circumstances, endurance swimming.

The main difference between dry suits and wetsuits is that dry suits are designed to prevent water entering. This generally allows better insulation making them more suitable for use in cold water. Dry suits can be uncomfortably hot in warm or hot air, and are typically more expensive and more complex to don. For divers, they add some degree of operational complexity as the suit must be inflated and deflated with changes in depth in order to minimize "squeeze" on descent or uncontrolled rapid ascent due to excessive buoyancy.



*Photo 5. Diving*

#### **4. NEOPRENE**

Neoprene is a type of synthetic rubber which can be foamed during manufacture to a high proportion of tiny enclosed gas bubbles, forming a buoyant and thermally-insulating material, called "foamed neoprene", "foam-neoprene" or "expanded neoprene".

Wetsuits are made from this material as it is a good insulator, waterproof, and is flexible enough for comfortable wear. The neoprene alone is very flexible, but not very resistant to tearing, so it is skinned with a layer of knit fabric bonded to each side for strength and abrasion resistance. Foamed neoprene may be used for the shell of a drysuit, providing some insulation due to the gas within the material, as in a standard wetsuit. If torn or punctured, leading to flooding, a foam-neoprene suit retains the insulation and buoyancy of the gas bubbles, like a wet suit, which is proportional to the thickness of the foam. Although foamed-neoprene dry suits provide some insulation, thermal under-suits are usually worn in cold water.

Neoprene is DuPont's protected name for poly-chlorophene.

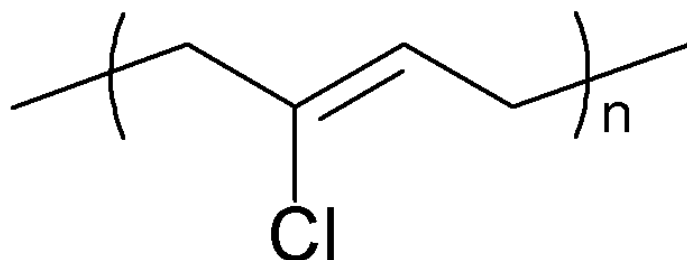

Photo 6. Chemical structure of polychloroprene

Neoprene was invented by DuPont scientist Dr Elmer K. Bolton on April 17, 1930, after a lecture by Julius Arthur Nieuwland, a chemistry professor at Notre Dame University.

Neoprene, originally called Duprene, was the first synthetic tire mass produced for general purposes.

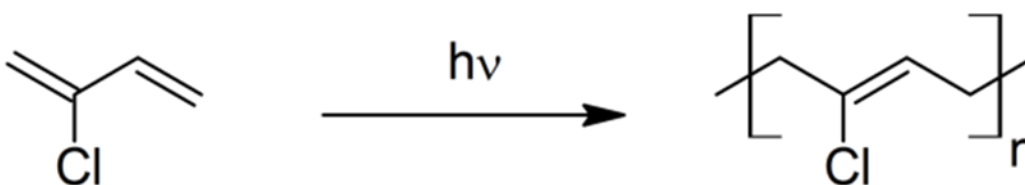

Photo 7. Free radical production of neoprene, with the main product shown

Neoprene dry suits are generally not as easy to put on and remove as are membrane dry suits, largely due to a closer fit which is possible due to the inherent elasticity of the material, and partly due to greater weight. As with wet suits, their buoyancy and thermal protection decreases with depth as the air bubbles in the neoprene are compressed. The air or other gas in the dry fabric undergarments providing insulation under a dry suit is also compressed, but can be restored to an effective volume by inflating the drysuit at depth through an inflator valve, thus preventing "suit squeeze" and compacting of the air-filled undersuit. Foam-neoprene tends to shrink over the years as it loses gas from the foam and slowly becomes less flexible as it ages.

An alternative is crushed or compressed foam neoprene, which is less susceptible to volume changes when under pressure. Crushed neoprene is foam neoprene which has been hydrostatically compressed so much that the gas bubbles have been mostly eliminated, this retains the elasticity of foamed neoprene which allows freedom of movement, but does not provide much insulation, and is functionally more like a membrane suit.



*Photo 8. Diving suit made of neoprene*

Neoprene resists degradation more than natural or synthetic rubber. This relative inertness makes it well suited for demanding applications such as gaskets, hoses, and corrosion-resistant coatings. It can be used as a base for adhesives, noise isolation in power transformer installations, and as padding in external metal cases to protect the contents while allowing a snug fit. It resists burning better than exclusively hydrocarbon based rubbers, resulting in its appearance in weather stripping for fire doors and in combat related attire such as gloves and face masks. Because of its tolerance of extreme conditions, neoprene is used to line landfills. Neoprene's burn point is around 260 °C (500 °F)

In its native state, neoprene is a very pliable rubber-like material with insulating properties similar to rubber or other solid plastics.

Neoprene foam is used in many applications and is produced in either closed-cell or open-cell form. The closed-cell form is waterproof, less compressible and more expensive. The open-cell form can be breathable. It is manufactured by foaming the rubber with nitrogen gas, where the tiny enclosed and separated gas bubbles can also serve as insulation. Nitrogen gas is most commonly used for the foaming of Neoprene foam due to its inertness, flame resistance, and large range of processing temperatures.



*Photo 9. Neoprene fabric*



*Photo 10. The reasons why it is neoprene is used to make diving suits and why it is better than other blends for this purpose*

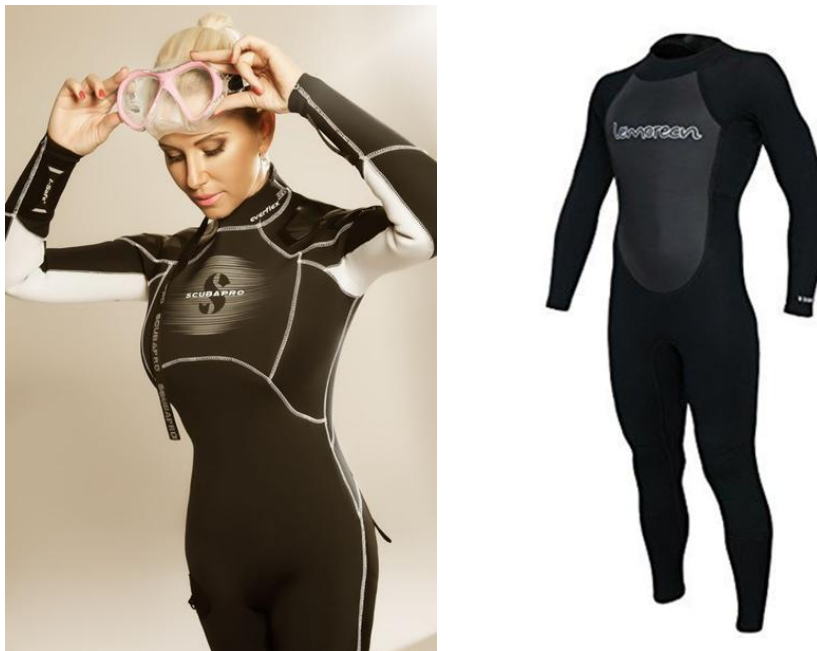

*Photo 11. Neoprene suit*

## 5. CONCLUSION

Thanks to the above-mentioned inventors, man can now explore the depths of the sea and the ocean, to see the beauty of the underwater world and to enjoy it in the visible. They also have good comfort and adequate protection in these ranching suits while at the bottom or at the bottom of the cold and other easier forms of threat. Neoprene is used not only for diving suits, it is also used for many other items of clothing that are worn in everyday life as well as for home use. This material will develop, with it it will be assigned to the wider and wider.





*Photo 122. Neoprene bag*



*Photo 121. Neoprene blazer*

## 6. LITERATURE

1. <https://en.wikipedia.org/wiki/Wetsuit>
2. <http://www.drysuitdiving.org/>
3. [https://sr.wikipedia.org/sr-el/Рекреативно\\_роњење#%D0%A0%D0%BE%D0%BD%D0%B8%D0%BB%D0%B0%D1%87%D0%BA%D0%B0\\_%D0%BE%D0%BF%D1%80%D0%B5%D0%BC%D0%B0](https://sr.wikipedia.org/sr-el/Рекреативно_роњење#%D0%A0%D0%BE%D0%BD%D0%B8%D0%BB%D0%B0%D1%87%D0%BA%D0%B0_%D0%BE%D0%BF%D1%80%D0%B5%D0%BC%D0%B0)
4. [http://www.ronjenjehrvatska.com/.main/upl\\_images/cnt\\_oprema.png](http://www.ronjenjehrvatska.com/.main/upl_images/cnt_oprema.png)
5. <https://sr.wikipedia.org/sr-el/Neopren>
6. <https://en.wikipedia.org/wiki/Neoprene>



---

**AUTHORS ADDRESSES**

---

## AUTHOPRS ADDRESSES

**Professor John Wilson**

Donghua University, Shanghai, China  
[johnwilson@dhu.edu.cn](mailto:johnwilson@dhu.edu.cn)

**Xu Ming**

Glorious Sun School of Business and  
Management, Donghua University,  
Shanghai, China  
[xuming@dhu.edu.cn](mailto:xuming@dhu.edu.cn)

**Andrej Agačević**

Glorious Sun School of Business and  
Management, Donghua University,  
Shanghai, China  
[a.agacevic@gmail.com](mailto:a.agacevic@gmail.com)

**Meiqun Na**

College of Fashion and Design, Donghua  
University, Shanghai, 200051, P.R. China

**Guoxiang Yuan**

Key Laboratory of Clothing Design &  
Technology, Ministry of Education,  
Shanghai 200051, P.R. China  
[vogue@126.com](mailto:vogue@126.com)

**Niloufar Khomarloo**

Institute for Advanced Textile Materials  
and Technology (ATMT), Textile  
Engineering Department, Amirkabir  
University of Technology, Tehran, Iran  
[khomarloo1@gmail.com](mailto:khomarloo1@gmail.com)

**Roohollah Bagherzadeh**

Institute for Advanced Textile Materials  
and Technology (ATMT), Textile  
Engineering Department, Amirkabir  
University of Technology, Tehran, Iran  
[bagherzadeh\\_r@aut.ac.ir](mailto:bagherzadeh_r@aut.ac.ir)

**Ramisa Yahyapour**

Textile Engineering Department,  
Amirkabir University, Tehran, Iran  
[Ramisa.yahyapoor@yahoo.com](mailto:Ramisa.yahyapoor@yahoo.com)

**Mohammad Sajad Sorayani Bafqi**

Textile Engineering Department, Textile  
Research and Excellence, Centers,  
Amirkabir University of Technology,  
Tehran, Iran  
Department of Civil and Industrial  
Engineering, University of Pisa, Pisa, Italy  
[S.Sorayani@aut.ac.ir](mailto:S.Sorayani@aut.ac.ir)

**Masoud Latifi**

Textile Engineering Department, Textile  
Research and Excellence, Centers,  
Amirkabir University of Technology,  
Tehran, Iran  
[Latifi@aut.ac.ir](mailto:Latifi@aut.ac.ir)

**Roohollah Bagherzadeh**

Institute for Advanced Textile Materials  
and Technology (ATMT), Textile  
Engineering Department, Amirkabir  
University of Technology, Tehran, Iran  
[Bagherzadeh\\_r@aut.ac.ir](mailto:Bagherzadeh_r@aut.ac.ir)

**Dragan Djordjic**

CIS Institute, Belgrade  
[ddjordjic@yahoo.com](mailto:ddjordjic@yahoo.com)

**Arzu Yavas**

Pamukkale University, Faculty of  
Engineering, Textile Engineering  
Department, Denizli /TURKEY 20160  
[aozerdem@pau.edu.tr](mailto:aozerdem@pau.edu.tr)

**Mirjana Reljic**

CIS Institute, Belgrade  
[reljicmira@gmail.com](mailto:reljicmira@gmail.com)

**Tugce Tonguc**

Pamukkale University, Faculty of  
Engineering, Textile Engineering  
Department, Denizli /TURKEY 20160

**Can B. Kalayci**

Department of Industrial Engineering,  
Pamukkale University, 20160, Denizli,  
Turkey  
[cbkalayci@pau.edu.tr](mailto:cbkalayci@pau.edu.tr)

**Ece Kalayci**

Department of Textile Engineering,  
Pamukkale University, 20160, Denizli,  
Turkey  
[ekalayci@pau.edu.tr](mailto:ekalayci@pau.edu.tr)

**Ozan Avinc**

Department of Textile Engineering,  
Pamukkale University, 20160, Denizli,  
Turkey  
[oavinc@pau.edu.tr](mailto:oavinc@pau.edu.tr)

**Edit Csanák**

Associate Professor, Óbuda University  
Sándor Rejtő Faculty of Light Industry and  
Environmental Engineering  
Institute of Product Design  
[csanak.edit@rkk.uni-obuda.hu](mailto:csanak.edit@rkk.uni-obuda.hu)

**Eugenia Elena Riemschneider**

West University, Faculty of Arts and  
Design, Timisoara, Romania

**Veasna Tith**

The Royal University Of Fine Art  
[veasna.tith@gmail.com](mailto:veasna.tith@gmail.com)

**Kidus Sumec**

Sumec Ethiopia Textile and Garments  
Manufacturing PLC

**Jovan Stepanovic**

University of Nis, Faculty of Technology  
Leskovac  
[jovan64@yahoo.com](mailto:jovan64@yahoo.com)

**Fitsum Etefa (B. Sc)**

Ethiopian Institute of Textile and Fashion  
Technology, EiTEX, Bahir Dar University,  
Ethiopia, [Oneday790@gmail.com](mailto:Oneday790@gmail.com)

**Vasilije Petrovic**

University of Novi Sad, Technical faculty  
"Mihajlo Pupin" Zrenjanin  
Đure Đakovića bb, 23000 Zrenjanin  
[vlp@eunet.rs](mailto:vlp@eunet.rs)

**Vojislav Gligorijevic**

University of Nis, Faculty of Technology,  
Leskovac, Serbia  
[vojatrik@yahoo.com](mailto:vojatrik@yahoo.com)

**Goran Demboski**

Cyril and Methodius University in Skopje,  
Faculty of Technology and Metallurgy,  
Skopje, Macedonia  
[goran@tmf.ukim.edu.mk](mailto:goran@tmf.ukim.edu.mk)

**Radica Nacic**

University of Nis, Faculty of Technology,  
Leskovac, Serbia

**Nenad Cirkovic**  
University of Nis, Faculty of  
Technology, Leskovac, Serbia  
[nenadcira@gmail.com](mailto:nenadcira@gmail.com)

**Maja Jankoska**  
University "Ss. Cyril and Methodius",  
Faculty of Technology and Metallurgy,  
Department of Textile, 1000 Skopje, North  
Macedonia  
[maja@tmf.ukim.edu.mk](mailto:maja@tmf.ukim.edu.mk)

**Nina Mladenovic**  
Faculty of technology and metallurgy,  
University Ss. Cyril and Methodius  
Rudjer Boskovic 16, 1000 Skopje,  
Republic of Macedonia

**Emilija Toshikj**  
Faculty of technology and metallurgy,  
University Ss. Cyril and Methodius  
Rudjer Boskovic 16, 1000 Skopje,  
Republic of Macedonia

**Igor Jordanov**  
Faculty of technology and metallurgy,  
University Ss. Cyril and Methodius  
Rudjer Boskovic 16, 1000 Skopje,  
Republic of Macedonia  
[jordanov@tmf.ukim.edu.mk](mailto:jordanov@tmf.ukim.edu.mk)

**Vesna Dimova**  
Faculty of technology and metallurgy,  
University Ss. Cyril and Methodius  
Rudjer Boskovic 16, 1000 Skopje,  
Republic of Macedonia

**Dejan Dimitrovski**  
Faculty of technology and metallurgy,  
University Ss. Cyril and Methodius  
Rudjer Boskovic 16, 1000 Skopje,  
Republic of Macedonia

**Samir Pačavar, PhD**  
The Faculty of Technical Studies,  
University of Travnik, BiH  
Textile engineering and design  
[spacavar@bih.net.ba](mailto:spacavar@bih.net.ba)

**Andela Đurašković**  
Faculty of Technology in Leskovac,  
University of Nis, Serbia  
[andjeladjuraskovic000@gmail.com](mailto:andjeladjuraskovic000@gmail.com)

**Tatjana Šarac**  
Faculty of Technology in Leskovac,  
University of Nis, Serbia  
[tangerine.art83@gmail.com](mailto:tangerine.art83@gmail.com)

**Jovana Lazić**  
Faculty of Technology in Leskovac,  
University of Nis, Serbia  
[jovanajox@gmail.com](mailto:jovanajox@gmail.com)

**Marija Pešić**  
Technical Faculty "Mihajlo Pupin",  
Zrenjanin, University of Novi Sad  
Đure Đakovića bb, 23000 Zrenjanin  
[marija.stankovic.986@gmail.com](mailto:marija.stankovic.986@gmail.com)

**Danka Joksimović**  
Technical Faculty "Mihajlo Pupin",  
Zrenjanin, University of Novi Sad  
Đure Đakovića bb, 23000 Zrenjanin  
[danka.joksimovic21@gmail.com](mailto:danka.joksimovic21@gmail.com)

**Anita Milosavljević**  
Technical Faculty "Mihajlo Pupin",  
Zrenjanin, University of Novi Sad  
Đure Đakovića bb, 23000 Zrenjanin  
[anita.milosavljevic@hotmail.com](mailto:anita.milosavljevic@hotmail.com)

**Blaženka Brlobašić Šajatović**  
Faculty of Textile Technology University  
of Zagreb

**Stanislava Sindelić**  
Technical Faculty "Mihajlo Pupin",  
Zrenjanin, University of Novi Sad  
Đure Đakovića bb, 23000 Zrenjanin  
[s.stasa@yahoo.com](mailto:s.stasa@yahoo.com)

**Ksenija Doležal**  
Faculty of Textile Technology University  
of Zagreb

**Darko Ujević**  
Faculty of Textile Technology University  
of Zagreb  
[darko.ujevic@zg.t-com.hr](mailto:darko.ujevic@zg.t-com.hr)

**Nenad Stojanović**  
Yumco Munchen, Germany

**Dragan Čočkalović**  
University of Novi Sad, Technical faculty  
“Mihajlo Pupin”, Zrenjanin, Serbia  
Đure Đakovića bb, 23000 Zrenjanin  
[cole@tfzr.uns.ac.rs](mailto:cole@tfzr.uns.ac.rs)

**Sanja Stanisavljev**  
University of Novi Sad, Technical faculty  
“Mihajlo Pupin”, Zrenjanin, Serbia  
Đure Đakovića bb, 23000 Zrenjanin  
[sanja.stanisavljev@tfzr.rs](mailto:sanja.stanisavljev@tfzr.rs)

**Nataša Stamenković**  
Faculty of Technology in Leskovac,  
University of Nis, Serbia  
[nradmanovac@gmail.com](mailto:nradmanovac@gmail.com)

**Mila Kavalčić**  
University of Novi Sad, Technical faculty  
“Mihajlo Pupin”, 23000 Zrenjanin,  
Đure Đakovića bb, Republic of Serbia  
[milazakin@gmail.com](mailto:milazakin@gmail.com)

**Vladimir Milaković**  
Sitotehnika - Mimaki, Japan  
[sitotehnika@gmail.com](mailto:sitotehnika@gmail.com)

**Renata Hrženjak**  
Faculty of Textile Technology University  
of Zagreb

**Dušan Trajković**  
Faculty Of Technology Leskovac,  
University Of Nis - The Scholarship  
Holder Of The Ministry  
[dusan@tf.ni.ac.rs](mailto:dusan@tf.ni.ac.rs)

**Mihalj Bakator**  
University of Novi Sad, Technical faculty  
“Mihajlo Pupin”, Zrenjanin, Serbia  
Đure Đakovića bb, 23000 Zrenjanin  
[mihaljbakator@gmail.com](mailto:mihaljbakator@gmail.com)

**Dejan Đorđević**  
University of Novi Sad, Technical faculty  
“Mihajlo Pupin”, Zrenjanin, Serbia  
Đure Đakovića bb, 23000 Zrenjanin  
[dejan.djordjevic@tfzr.rs](mailto:dejan.djordjevic@tfzr.rs)

**Srdan Bogetić**  
Academy of Business Professional Studies  
Belgrade, 11000 Belgrade, Kraljice Marije  
73, Republic of Serbia  
[srdjan.bogetic@bpa.edu.rs](mailto:srdjan.bogetic@bpa.edu.rs)

**Nadežda Ljubojev**  
University of Novi Sad, Technical faculty  
“Mihajlo Pupin”, 23000 Zrenjanin,  
Đure Đakovića bb, Republic of Serbia  
[nadezdaljubojev@gmail.com](mailto:nadezdaljubojev@gmail.com)

**Gabrijela Grujić**  
Assistant Minister Ministry of Education,  
Science and Technological Development,  
Republic of Serbia,  
[gabrijela.grujic@mpn.gov.rs](mailto:gabrijela.grujic@mpn.gov.rs)

**Marko Marinković**  
Sitotehnika - Mimaki, Japan  
[sitotehnika@gmail.com](mailto:sitotehnika@gmail.com)

**Jovan Radisic**

Technical Faculty "Mihajlo Pupin",  
Zrenjanin - Đure Đakovića bb, 23000  
Zrenjanin  
[j.radisic98@hotmail.com](mailto:j.radisic98@hotmail.com)

**Valentina Bozoki**

Technical Faculty "Mihajlo Pupin",  
Zrenjanin - Đure Đakovića bb, 23000  
Zrenjanin  
[vanjica.bozoki@gmail.com](mailto:vanjica.bozoki@gmail.com)

**Mina Milaković**

Technical Faculty "Mihajlo Pupin",  
Zrenjanin - Đure Đakovića bb, 23000  
Zrenjanin  
[minamilakovic0@gmail.com](mailto:minamilakovic0@gmail.com)

**Ivana Krulj**

Technical Faculty "Mihajlo Pupin",  
Zrenjanin - Đure Đakovića bb, 23000  
Zrenjanin  
[ivana.krulj55@gmail.com](mailto:ivana.krulj55@gmail.com)

**Jelena Đukić**

Technical Faculty "Mihajlo Pupin",  
Zrenjanin - Đure Đakovića bb, 23000  
Zrenjanin  
[jelenadjukic09@gmail.com](mailto:jelenadjukic09@gmail.com)

**Nikola Petrović**

Technical Faculty "Mihajlo Pupin",  
Zrenjanin, University of Novi Sad  
Đure Đakovića bb, 23000 Zrenjanin  
[petrovic.n26@gmail.com](mailto:petrovic.n26@gmail.com)

**Milica Stojanović**

Technical Faculty "Mihajlo Pupin",  
Zrenjanin - Đure Đakovića bb, 23000  
Zrenjanin  
[stojanovic.milica407@gmail.com](mailto:stojanovic.milica407@gmail.com)